

High Efficiency Thyristor

Single Thyristor

$V_{RRM} = 1200 \text{ V}$
 $I_{T(AV)M} = 30 \text{ A}$
 $I_{T(RMS)} = 47 \text{ A}$

Part number

CLA 30 E 1200 PC

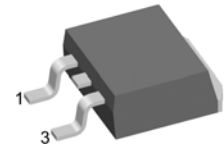
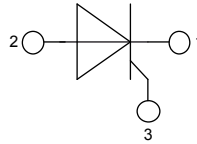

Backside: anode

Features / Advantages:

- Thyristor for line frequency
- Planar passivated chip
- Long-term stability

Applications:

- Softstart AC motor control
- DC Motor control
- Power converter
- AC power control
- Lighting and temperature control

Package:

- Housing: TO-263 (D2Pak)
- Industry standard outline
- Epoxy meets UL 94V-0
- RoHS compliant

Ratings

Symbol	Definition	Conditions	Ratings			Unit	
			min.	typ.	max.		
$V_{RSM/DSM}$	max. non-repetitive reverse/forward blocking voltage	$T_{VJ} = 25^{\circ}\text{C}$			1300	V	
$V_{RRM/DRM}$	max. repetitive reverse/forward blocking voltage	$T_{VJ} = 25^{\circ}\text{C}$			1200	V	
I_{RD}	reverse current, drain current	$V_{RD} = 1200 \text{ V}$			10	μA	
		$V_{RD} = 1200 \text{ V}$			2	mA	
V_T	forward voltage drop	$I_T = 30 \text{ A}$			1.30	V	
		$I_T = 60 \text{ A}$			1.59	V	
		$I_T = 30 \text{ A}$	$T_{VJ} = 125^{\circ}\text{C}$			1.27	V
		$I_T = 60 \text{ A}$	$T_{VJ} = 125^{\circ}\text{C}$			1.65	V
$I_{T(AV)M}$	average forward current	$T_C = 115^{\circ}\text{C}$			30	A	
$I_{T(RMS)}$	RMS forward current	180° sine			47	A	
V_{T0}	threshold voltage	$T_{VJ} = 150^{\circ}\text{C}$			0.86	V	
r_T	slope resistance } for power loss calculation only				13.2	m Ω	
R_{thJC}	thermal resistance junction to case				0.65	K/W	
T_{VJ}	virtual junction temperature		-40		150	$^{\circ}\text{C}$	
P_{tot}	total power dissipation	$T_C = 25^{\circ}\text{C}$			190	W	
P_{GM}	max. gate power dissipation	$t_p = 30 \mu\text{s}$			10	W	
		$t_p = 300 \mu\text{s}$			5	W	
P_{GAV}	average gate power dissipation				0.5	W	
I_{TSM}	max. forward surge current	$t = 10 \text{ ms}; (50 \text{ Hz}), \text{ sine}$	$T_{VJ} = 45^{\circ}\text{C}$		300	A	
		$t = 8,3 \text{ ms}; (60 \text{ Hz}), \text{ sine}$	$V_R = 0 \text{ V}$		325	A	
		$t = 10 \text{ ms}; (50 \text{ Hz}), \text{ sine}$	$T_{VJ} = 150^{\circ}\text{C}$		255	A	
		$t = 8,3 \text{ ms}; (60 \text{ Hz}), \text{ sine}$	$V_R = 0 \text{ V}$		275	A	
I^2t	value for fusing	$t = 10 \text{ ms}; (50 \text{ Hz}), \text{ sine}$	$T_{VJ} = 45^{\circ}\text{C}$		450	A ² s	
		$t = 8,3 \text{ ms}; (60 \text{ Hz}), \text{ sine}$	$V_R = 0 \text{ V}$		440	A ² s	
		$t = 10 \text{ ms}; (50 \text{ Hz}), \text{ sine}$	$T_{VJ} = 150^{\circ}\text{C}$		325	A ² s	
		$t = 8,3 \text{ ms}; (60 \text{ Hz}), \text{ sine}$	$V_R = 0 \text{ V}$		315	A ² s	
C_J	junction capacitance	$V_R = 400 \text{ V}$ $f = 1 \text{ MHz}$	$T_{VJ} = 25^{\circ}\text{C}$		13	pF	

Symbol	Definition	Conditions	Ratings			Unit
			min.	typ.	max.	
$(di/dt)_{cr}$	<i>critical rate of rise of current</i>	$T_{VJ} = 150\text{ }^{\circ}\text{C}$ repetitive, $I_T = 40\text{ A}$ $f = 50\text{ Hz}$; $t_p = 200\text{ }\mu\text{s}$ $I = 0.3\text{ A}$; $di/dt = 0.3\text{ A}/\mu\text{s}$			150	$\text{A}/\mu\text{s}$
		$V_D = \frac{2}{3} V_{DRM}$ non-repetitive, $I_T = 30\text{ A}$			500	$\text{A}/\mu\text{s}$
$(dv/dt)_{cr}$	<i>critical rate of rise of voltage</i>	$V_D = \frac{2}{3} V_{DRM}$ $T_{VJ} = 150\text{ }^{\circ}\text{C}$ $R_{GK} = \infty$; method 1 (linear voltage rise)			500	$\text{V}/\mu\text{s}$
V_{GT}	<i>gate trigger voltage</i>	$V_D = 6\text{ V}$ $T_{VJ} = 25\text{ }^{\circ}\text{C}$ $T_{VJ} = -40\text{ }^{\circ}\text{C}$			1.3	V
I_{GT}	<i>gate trigger current</i>	$V_D = 6\text{ V}$ $T_{VJ} = 25\text{ }^{\circ}\text{C}$ $T_{VJ} = -40\text{ }^{\circ}\text{C}$			1.6	V
					30	mA
V_{GD}	<i>gate non-trigger voltage</i>	$V_D = \frac{2}{3} V_{DRM}$ $T_{VJ} = 150\text{ }^{\circ}\text{C}$			0.2	V
I_{GD}	<i>gate non-trigger current</i>				1	mA
I_L	<i>latching current</i>	$t_p = 10\text{ }\mu\text{s}$ $T_{VJ} = 25\text{ }^{\circ}\text{C}$ $I = 0.3\text{ A}$; $di/dt = 0.3\text{ A}/\mu\text{s}$			90	mA
I_H	<i>holding current</i>	$V_D = 6\text{ V}$ $R_{GK} = \infty$ $T_{VJ} = 25\text{ }^{\circ}\text{C}$			60	mA
t_{gd}	<i>gate controlled delay time</i>	$V_D = \frac{1}{2} V_{DRM}$ $T_{VJ} = 25\text{ }^{\circ}\text{C}$ $I = 0.3\text{ A}$; $di/dt = 0.3\text{ A}/\mu\text{s}$			2	μs
t_q	<i>turn-off time</i>	$V_R = 100\text{ V}$; $I_T = 30\text{ A}$ $T_{VJ} = 150\text{ }^{\circ}\text{C}$ $V_D = \frac{2}{3} V_{DRM}$; $t_p = 200\text{ }\mu\text{s}$ $di/dt = 10\text{ A}/\mu\text{s}$; $dv/dt = 20\text{ V}/\mu\text{s}$		150		μs

Symbol	Definition	Conditions	Ratings			Unit
			min.	typ.	max.	
I_{RMS}	RMS current	per terminal			35	A
R_{thCH}	thermal resistance case to heatsink			0.25		K/W
T_{stg}	storage temperature		-55		150	°C
Weight				2		g
F_C	mounting force with clip		20		60	N

Part number

- C = Thyristor (SCR)
- L = High Efficiency Thyristor
- A = (up to 1200 V)
- 30 = Current Rating [A]
- E = Single Part
- 1200 = Reverse Voltage [V]
- PC = TO-263AB (D2Pak) (2)

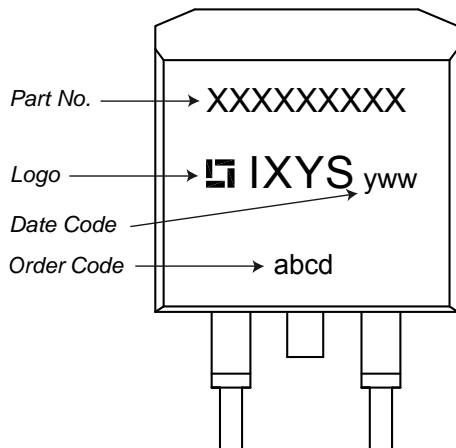
Product Marking

Ordering	Part Name	Marking on Product	Delivering Mode	Base Qty	Code Key
Standard	CLA 30 E 1200 PC	CLA30E1200PC	Tape & Reel	800	508235

Similar Part	Package	Voltage class
CLA30E1200PB	TO-220AB (3)	1200
CLA30E1200HB	TO-247AD (3)	1200
CS22-12io1M	TO-220ABFP (3)	1200
CS22-08io1M	TO-220ABFP (3)	800
CMA30E1600PN	TO-220ABFP (3)	1600
CMA30E1600PB	TO-220AB (3)	1600

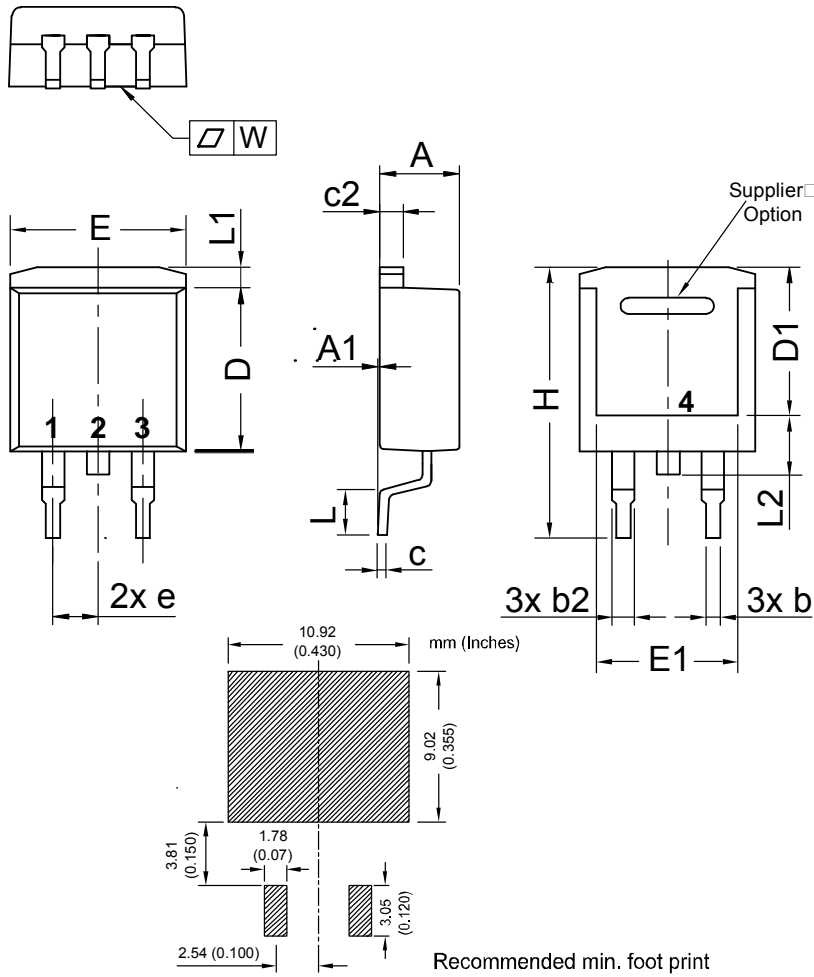
Outlines TO-263 (D2Pak)

Dim.	Millimeter		Inches	
	min	max	min	max
A	4.06	4.83	0.160	0.190
A1	typ. 0.10		typ. 0.004	
b	0.51	0.99	0.020	0.039
b2	1.14	1.40	0.045	0.055
c	0.40	0.74	0.016	0.029
c2	1.14	1.40	0.045	0.029
D	8.38	9.40	0.330	0.370
D1	8.00	8.89	0.315	0.350
E	9.65	10.41	0.380	0.410
E1	6.22	8.20	0.245	0.323
e	2,54 BSC		0,100 BSC	
H	14.61	15.88	0.575	0.625
L	1.78	2.79	0.070	0.110
L1	1.02	1.68	0.040	0.066
L2	1.02	1.52	0.040	0.060
W	typ. 0.02	0.040	typ. 0.0008	0.0016

All dimensions conform with and/or are within JEDEC standard.

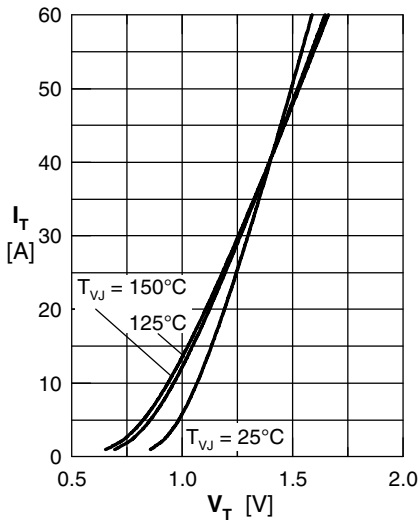

Fig. 1 Forward characteristics

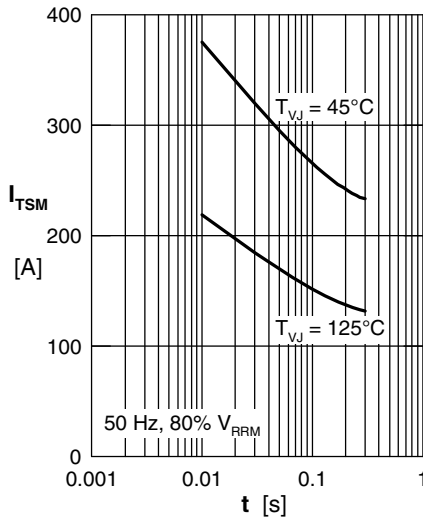

Fig. 2 Surge overload current
 I_{TSM} : crest value, t: duration

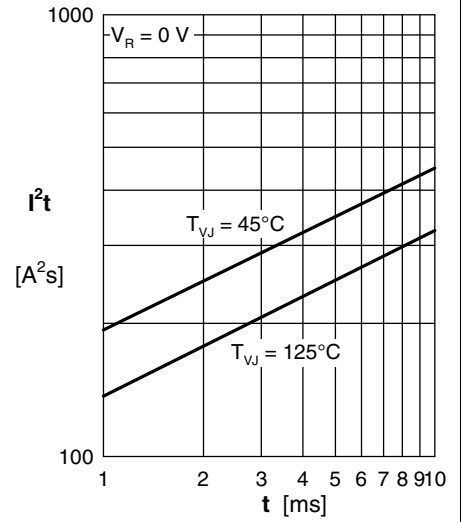

Fig. 3 I^2t versus time (1-10 s)

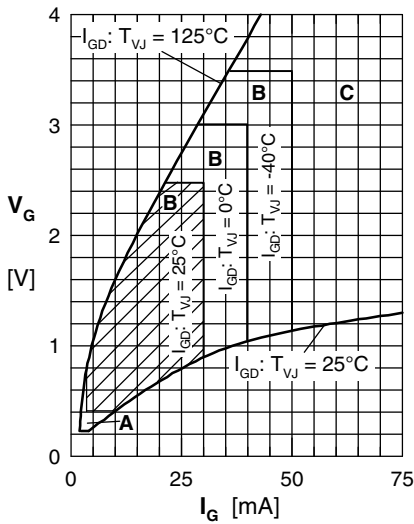

Fig. 4 Gate voltage & gate current
Triggering: A = no; B = possible; C = safe

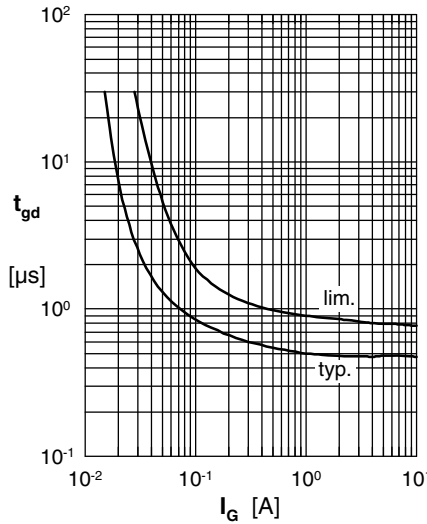

Fig. 5 Gate controlled delay time t_{gd}

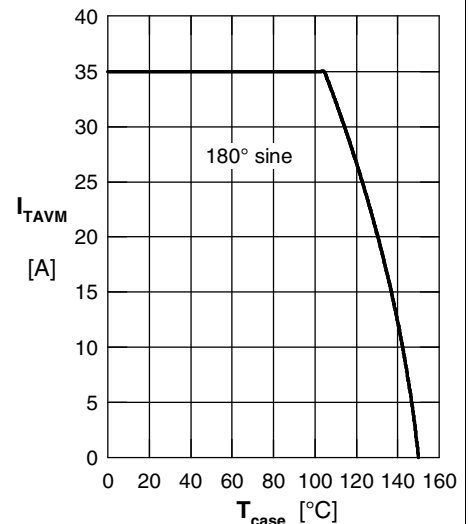

Fig. 6 Max. forward current at case temperature

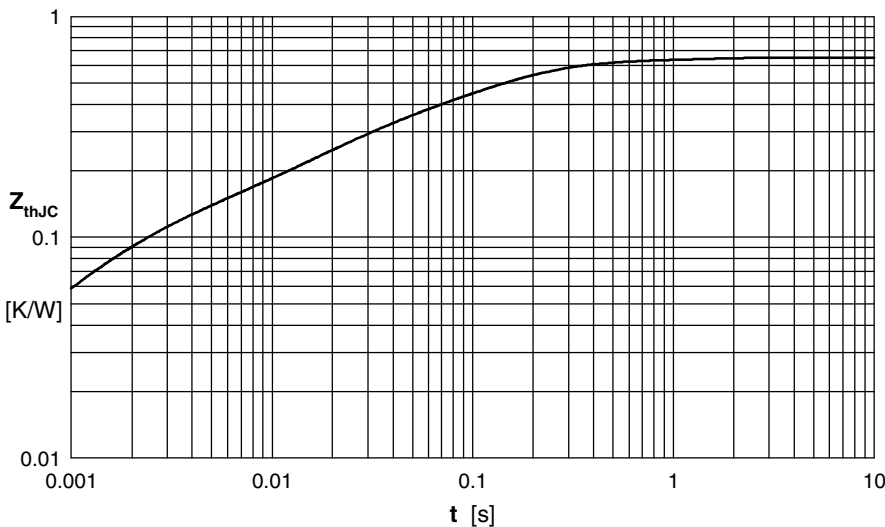

Fig. 7 Transient thermal impedance junction to case

Constants for Z_{thJC} calculation:

i	R_{thi} (K/W)	t_i (s)
1	0.024	0.0007
2	0.069	0.0018
3	0.148	0.018
4	0.053	0.12
5	0.356	0.76