

High Efficiency Thyristor

Single Thyristor

$V_{RRM} = 1200\text{ V}$
 $I_{T(AV)M} = 50\text{ A}$
 $I_{T(RMS)} = 79\text{ A}$

Part number

CLA 50 E 1200 HB

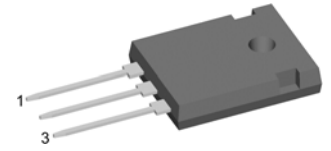
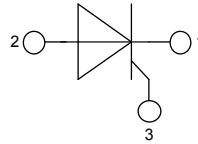

Backside: anode

Features / Advantages:

- Thyristor for line frequency
- Planar passivated chip
- Long-term stability

Applications:

- Softstart AC motor control
- DC Motor control
- Power converter
- AC power control
- Lighting and temperature control

Package:

- Housing: TO-247
- Industry standard outline
- Epoxy meets UL 94V-0
- RoHS compliant

Symbol	Definition	Conditions	Ratings			Unit	
			min.	typ.	max.		
$V_{RSM/DSM}$	max. non-repetitive reverse/forward blocking voltage	$T_{VJ} = 25^{\circ}\text{C}$			1300	V	
$V_{RRM/DRM}$	max. repetitive reverse/forward blocking voltage	$T_{VJ} = 25^{\circ}\text{C}$			1200	V	
I_{RD}	reverse current, drain current	$V_{RD} = 1200\text{ V}$			50	μA	
		$V_{RD} = 1200\text{ V}$			4	mA	
V_T	forward voltage drop	$I_T = 50\text{ A}$			1.32	V	
		$I_T = 100\text{ A}$			1.60	V	
		$I_T = 50\text{ A}$	$T_{VJ} = 125^{\circ}\text{C}$			1.27	V
		$I_T = 100\text{ A}$	$T_{VJ} = 125^{\circ}\text{C}$			1.65	V
$I_{T(AV)M}$	average forward current	$T_C = 125^{\circ}\text{C}$			50	A	
$I_{T(RMS)}$	RMS forward current	180° sine			79	A	
V_{T0}	threshold voltage	} for power loss calculation only	$T_{VJ} = 150^{\circ}\text{C}$		0.88	V	
r_T	slope resistance				7.7	m Ω	
R_{thJC}	thermal resistance junction to case				0.25	K/W	
T_{VJ}	virtual junction temperature		-40		150	$^{\circ}\text{C}$	
P_{tot}	total power dissipation	$T_C = 25^{\circ}\text{C}$			500	W	
P_{GM}	max. gate power dissipation	$t_p = 30\ \mu\text{s}$	$T_C = 150^{\circ}\text{C}$		10	W	
		$t_p = 300\ \mu\text{s}$			1	W	
P_{GAV}	average gate power dissipation				0.5	W	
I_{TSM}	max. forward surge current	$t = 10\text{ ms}; (50\text{ Hz}), \text{ sine}$	$T_{VJ} = 45^{\circ}\text{C}$		550	A	
		$t = 8,3\text{ ms}; (60\text{ Hz}), \text{ sine}$	$V_R = 0\text{ V}$		595	A	
		$t = 10\text{ ms}; (50\text{ Hz}), \text{ sine}$	$T_{VJ} = 150^{\circ}\text{C}$		470	A	
		$t = 8,3\text{ ms}; (60\text{ Hz}), \text{ sine}$	$V_R = 0\text{ V}$		505	A	
I^2t	value for fusing	$t = 10\text{ ms}; (50\text{ Hz}), \text{ sine}$	$T_{VJ} = 45^{\circ}\text{C}$		1.52	kA ² s	
		$t = 8,3\text{ ms}; (60\text{ Hz}), \text{ sine}$	$V_R = 0\text{ V}$		1.48	kA ² s	
		$t = 10\text{ ms}; (50\text{ Hz}), \text{ sine}$	$T_{VJ} = 150^{\circ}\text{C}$		1.11	kA ² s	
		$t = 8,3\text{ ms}; (60\text{ Hz}), \text{ sine}$	$V_R = 0\text{ V}$		1.06	kA ² s	
C_J	junction capacitance	$V_R = 400\text{ V}$ $f = 1\text{ MHz}$	$T_{VJ} = 25^{\circ}\text{C}$		25	pF	

Symbol	Definition	Conditions	Ratings			Unit
			min.	typ.	max.	
$(di/dt)_{cr}$	<i>critical rate of rise of current</i>	$T_{VJ} = 150\text{ }^{\circ}\text{C}$ repetitive, $I_T = 40\text{ A}$ $f = 50\text{ Hz}$; $t_p = 200\text{ }\mu\text{s}$ $I = 0.3\text{ A}$; $di/dt = 0.3\text{ A}/\mu\text{s}$			150	$\text{A}/\mu\text{s}$
		$V_D = \frac{2}{3} V_{DRM}$ non-repetitive, $I_T = 50\text{ A}$			500	$\text{A}/\mu\text{s}$
$(dv/dt)_{cr}$	<i>critical rate of rise of voltage</i>	$V_D = \frac{2}{3} V_{DRM}$ $T_{VJ} = 150\text{ }^{\circ}\text{C}$ $R_{GK} = \infty$; method 1 (linear voltage rise)			1000	$\text{V}/\mu\text{s}$
V_{GT}	<i>gate trigger voltage</i>	$V_D = 6\text{ V}$ $T_{VJ} = 25\text{ }^{\circ}\text{C}$ $T_{VJ} = -40\text{ }^{\circ}\text{C}$			1.5	V
I_{GT}	<i>gate trigger current</i>	$V_D = 6\text{ V}$ $T_{VJ} = 25\text{ }^{\circ}\text{C}$ $T_{VJ} = -40\text{ }^{\circ}\text{C}$			1.6	V
					50	mA
V_{GD}	<i>gate non-trigger voltage</i>	$V_D = \frac{2}{3} V_{DRM}$ $T_{VJ} = 150\text{ }^{\circ}\text{C}$			0.2	V
I_{GD}	<i>gate non-trigger current</i>				3	mA
I_L	<i>latching current</i>	$t_p = 10\text{ }\mu\text{s}$ $T_{VJ} = 25\text{ }^{\circ}\text{C}$ $I = 0.3\text{ A}$; $di/dt = 0.3\text{ A}/\mu\text{s}$			125	mA
I_H	<i>holding current</i>	$V_D = 6\text{ V}$ $R_{GK} = \infty$ $T_{VJ} = 25\text{ }^{\circ}\text{C}$			100	mA
t_{gd}	<i>gate controlled delay time</i>	$V_D = \frac{1}{2} V_{DRM}$ $T_{VJ} = 25\text{ }^{\circ}\text{C}$ $I = 0.3\text{ A}$; $di/dt = 0.3\text{ A}/\mu\text{s}$			2	μs
t_q	<i>turn-off time</i>	$V_R = 100\text{ V}$; $I_T = 33\text{ A}$ $T_{VJ} = 150\text{ }^{\circ}\text{C}$ $V_D = \frac{2}{3} V_{DRM}$; $t_p = 200\text{ }\mu\text{s}$ $di/dt = 10\text{ A}/\mu\text{s}$; $dv/dt = 20\text{ V}/\mu\text{s}$		200		μs

Symbol	Definition	Conditions	Ratings			Unit
			min.	typ.	max.	
I_{RMS}	RMS current	per terminal			70	A
R_{thCH}	thermal resistance case to heatsink			0.25		K/W
T_{stg}	storage temperature		-55		150	°C
Weight				6		g
M_D	mounting torque		0.8		1.2	Nm
F_C	mounting force with clip		20		120	N

Part number

- C = Thyristor (SCR)
- L = High Efficiency Thyristor
- A = (up to 1200 V)
- 50 = Current Rating [A]
- E = Single Part
- 1200 = Reverse Voltage [V]
- HB = TO-247AD (3)

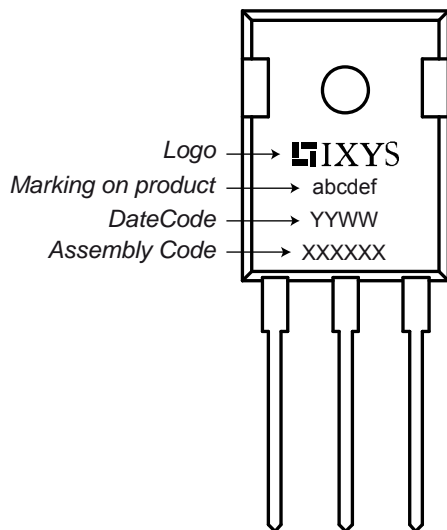
Product Marking

Ordering	Part Name	Marking on Product	Delivering Mode	Base Qty	Code Key
Standard	CLA 50 E 1200 HB	CLA50E1200HB	Tube	30	503748

Similar Part	Package	Voltage class
CLA50E1200TC	TO-268AA (D3Pak)	1200

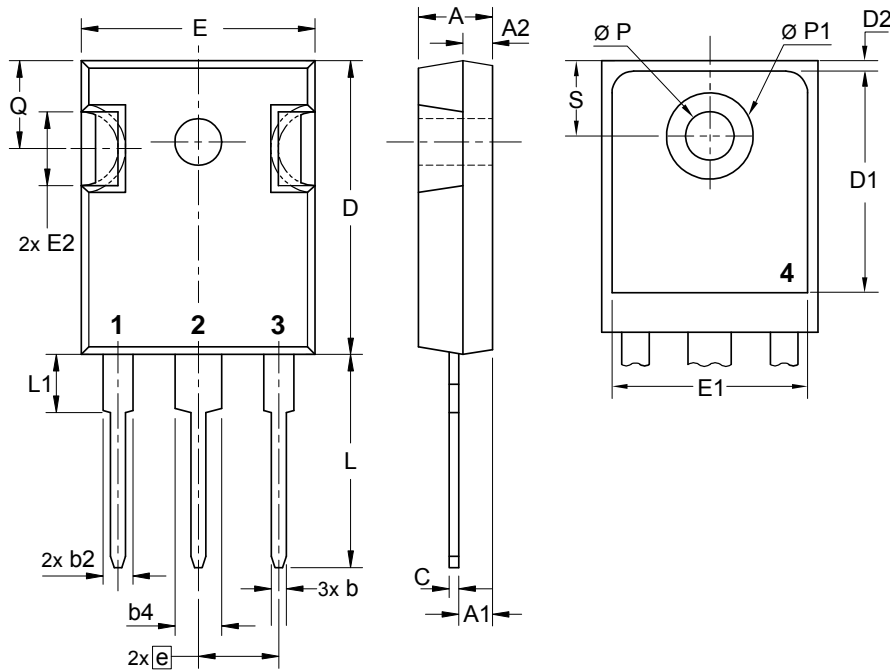
Outlines TO-247

Sym.	Inches		Millimeter	
	min.	max.	min.	max.
A	0.185	0.209	4.70	5.30
A1	0.087	0.102	2.21	2.59
A2	0.059	0.098	1.50	2.49
D	0.819	0.845	20.79	21.45
E	0.610	0.640	15.48	16.24
E2	0.170	0.216	4.31	5.48
e	0.215 BSC		5.46 BSC	
L	0.780	0.800	19.80	20.30
L1	-	0.177	-	4.49
Ø P	0.140	0.144	3.55	3.65
Q	0.212	0.244	5.38	6.19
S	0.242 BSC		6.14 BSC	
b	0.039	0.055	0.99	1.40
b2	0.065	0.094	1.65	2.39
b4	0.102	0.135	2.59	3.43
c	0.015	0.035	0.38	0.89
D1	0.515	-	13.07	-
D2	0.020	0.053	0.51	1.35
E1	0.530	-	13.45	-
Ø P1	-	0.29	-	7.39

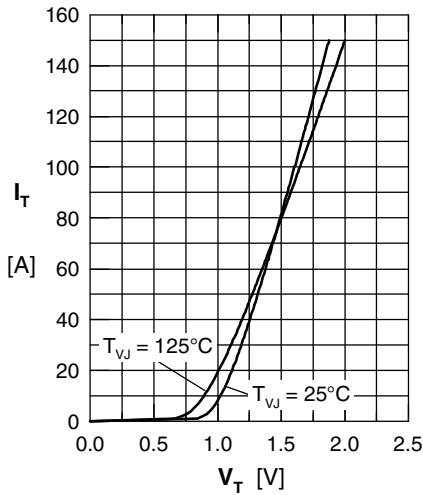

Fig. 1 Forward characteristics

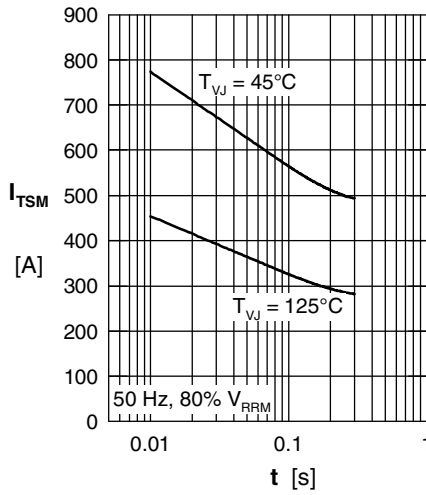

Fig. 2 Surge overload current

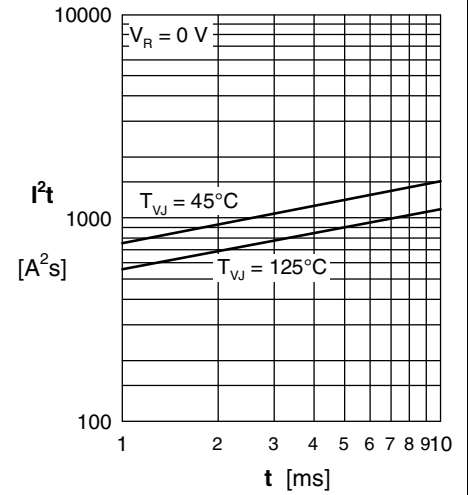

Fig. 3 I^2t versus time (1-10 ms)

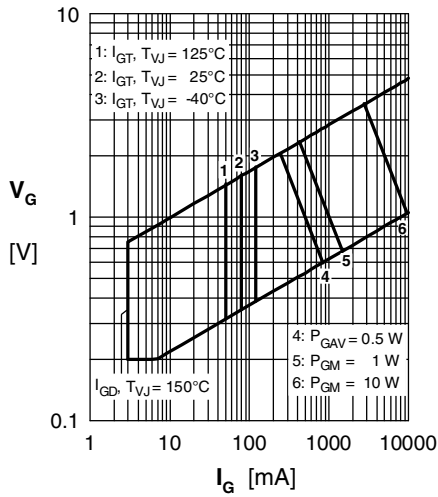

Fig. 4 Gate trigger characteristics

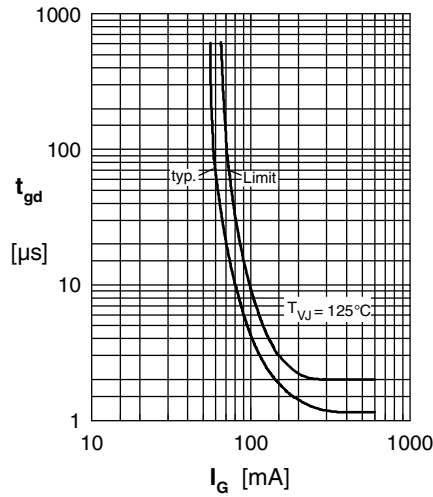

Fig. 5 Gate controlled delay time t_{gd}

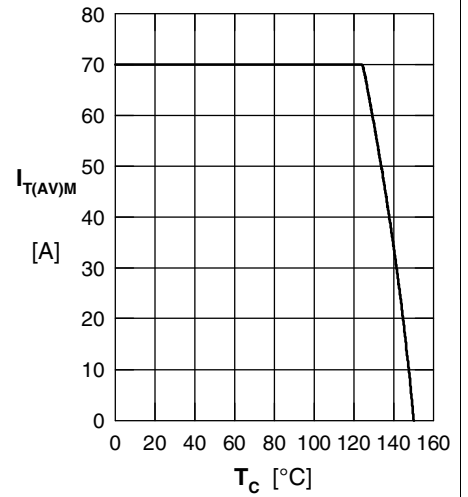

Fig. 6 Max. forward current at case temperature

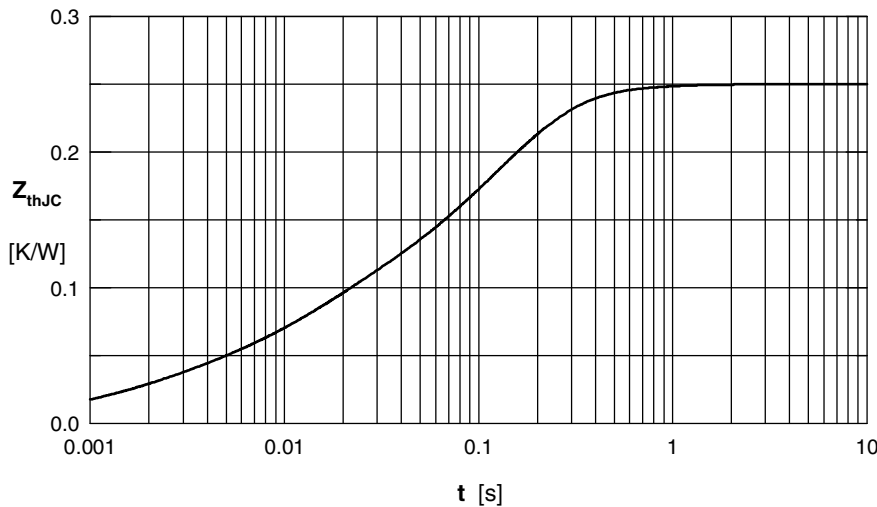

Fig. 7 Transient thermal impedance junction to case

Ri	τ_i
0.0075	0.0011
0.017	0.0019
0.057	0.0115
0.158	0.12
0.0105	0.5