

Phase Control Thyristors

$V_{RRM} = 800-1600 \text{ V}$
 $I_{T(RMS)} = 50 \text{ A}$
 $I_{T(AV)M} = 32 \text{ A}$

V_{RSM} V_{DSM} V	V_{RRM} V_{DRM} V	Type
900	800	CS 23-08io2
1300	1200	CS 23-12io2
1700	1600	CS 23-16io2

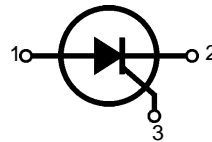

TO-208AA
(TO-48)

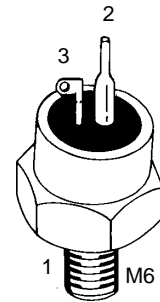

1 = Anode, 2 = Cathode, 3 = Gate

Symbol	Test Conditions	Maximum Ratings
$I_{T(RMS)}$	$T_{VJ} = T_{VJM}$	50 A
$I_{T(AV)M}$	$T_{case} = 85^{\circ}\text{C}; 180^{\circ}$ sine	25 A
	$T_{case} = 69^{\circ}\text{C}; 180^{\circ}$ sine	32 A
I_{TSM}	$T_{VJ} = 45^{\circ}\text{C}; V_R = 0$	t = 10 ms (50 Hz), sine 450 A t = 8.3 ms (60 Hz), sine 480 A
	$T_{VJ} = T_{VJM}; V_R = 0$	t = 10 ms (50 Hz), sine 400 A t = 8.3 ms (60 Hz), sine 430 A
I^2t	$T_{VJ} = 45^{\circ}\text{C}; V_R = 0$	t = 10 ms (50 Hz), sine 1010 A ² s t = 8.3 ms (60 Hz), sine 970 A ² s
	$T_{VJ} = T_{VJM}; V_R = 0$	t = 10 ms (50 Hz), sine 800 A ² s t = 8.3 ms (60 Hz), sine 770 A ² s
$(di/dt)_{cr}$	$T_{VJ} = T_{VJM}; f = 50\text{Hz}; t_p = 200\mu\text{s}; V_D = 2/3 V_{DRM}; I_G = 0.3 \text{ A}$	repetitive, $I_T = 75 \text{ A}$ 150 A/ μs
	$di_G/dt = 0.3 \text{ A}/\mu\text{s}$	non repetitive, $I_T = I_{T(AV)M}$ 500 A/ μs
$(dv/dt)_{cr}$	$T_{VJ} = T_{VJM}; R_{GK} = \infty; \text{method 1 (linear voltage rise)}$	$V_{DR} = 2/3 V_{DRM}$ 1000 V/ μs
P_{GM}	$T_{VJ} = T_{VJM}; t_p = 30 \mu\text{s}$	10 W
$P_{G(AV)}$	$I_T = I_{T(AV)M}; t_p = 300 \mu\text{s}$	5 W
V_{RGM}		0.5 W
T_{VJ}		10 V
T_{VJM}		-40...+125 °C
T_{stg}		125 °C
M_d	Mounting torque	-40...+125 °C
		2.7-3.3 Nm
		24-29 lb.in.
Weight		12 g

Features

- Thyristor for line frequencies
- International standard package JEDEC TO-208AA
- Planar glassivated chip
- Long-term stability of blocking currents and voltages

Applications

- Motor control
- Power converter
- AC power controller

Advantages

- Space and weight savings
- Simple mounting
- Improved temperature and power cycling

Dimensions in mm (1 mm = 0.0394")

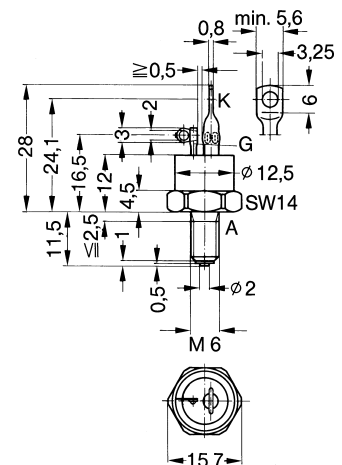

Data according to IEC 60747
IXYS reserves the right to change limits, test conditions and dimensions

Symbol	Test Conditions	Characteristic Values	
I_R, I_D	$T_{VJ} = T_{VJM}; V_R = V_{RRM}; V_D = V_{DRM}$	\leq	3 mA
V_T	$I_T = 80 \text{ A}; T_{VJ} = 25^\circ\text{C}$	\leq	1.8 V
V_{T0}	For power-loss calculations only ($T_{VJ} = 125^\circ\text{C}$)		1.0 V
r_T			10 m Ω
V_{GT}	$V_D = 6 \text{ V}; T_{VJ} = 25^\circ\text{C}$	\leq	2.5 V
	$T_{VJ} = -40^\circ\text{C}$	\leq	3.5 V
I_{GT}	$V_D = 6 \text{ V}; T_{VJ} = 25^\circ\text{C}$	\leq	50 mA
	$T_{VJ} = -40^\circ\text{C}$	\leq	80 mA
V_{GD}	$T_{VJ} = T_{VJM}; V_D = 2/3 V_{DRM}$	\leq	0.2 V
I_{GD}		\leq	1 mA
I_L	$T_{VJ} = 25^\circ\text{C}; t_p = 10 \mu\text{s}$ $I_G = 0.15 \text{ A}; di_G/dt = 0.15 \text{ A}/\mu\text{s}$	\leq	200 mA
I_H	$T_{VJ} = 25^\circ\text{C}; V_D = 6 \text{ V}; R_{GK} = \infty$	\leq	100 mA
t_{gd}	$T_{VJ} = 25^\circ\text{C}; V_D = 1/2 V_{DRM}$ $I_G = 0.15 \text{ A}; di_G/dt = 0.15 \text{ A}/\mu\text{s}$	\leq	2 μs
t_q	$T_{VJ} = T_{VJM}; I_T = 25 \text{ A}, t_p = 300 \mu\text{s}; di/dt = -20 \text{ A}/\mu\text{s}$ $V_R = 100 \text{ V}; dv/dt = 20 \text{ V}/\mu\text{s}; V_D = 2/3 V_{DRM}$	typ.	60 μs
R_{thJC}	DC current		1.0 K/W
R_{thJH}	DC current		1.61 K/W
d_s	Creepage distance on surface		1.5 mm
d_A	Strike distance through air		1.5 mm
a	Max. acceleration, 50 Hz		50 m/s ²

Accessories:

Nut M6 DIN 439/SW14

Lock washer A6 DIN 128

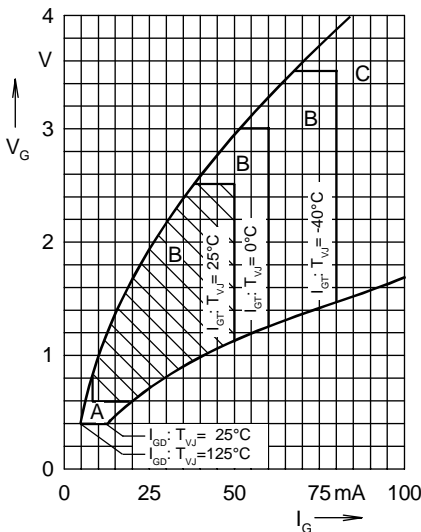

Fig. 1 Gate voltage and gate current
Triggering:
A = no; B = possible; C = safe

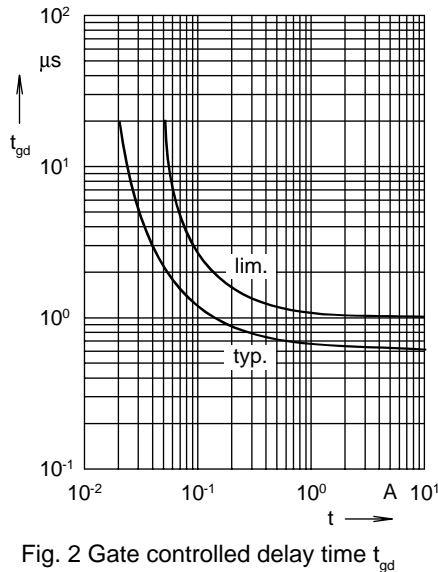

Fig. 2 Gate controlled delay time t_{gd}

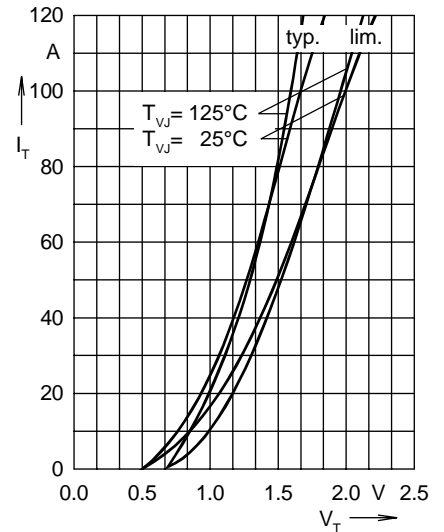

Fig. 3 On-state characteristics

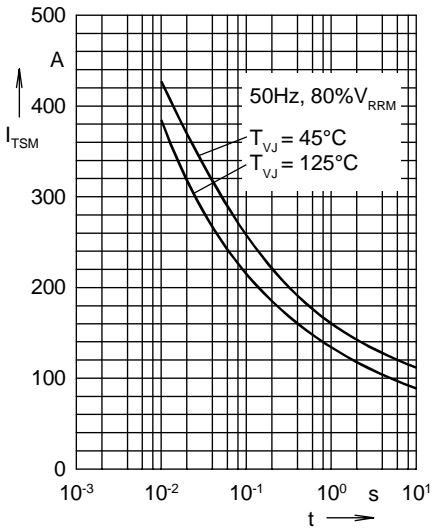

Fig. 4 Surge overload current
 I_{TSM} : crest value, t: duration

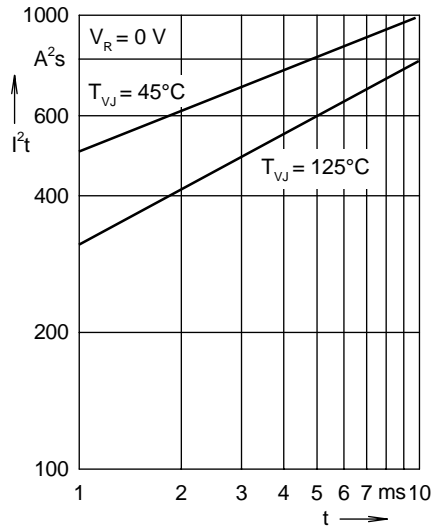

Fig. 5 I^2t versus time (1-10 ms)

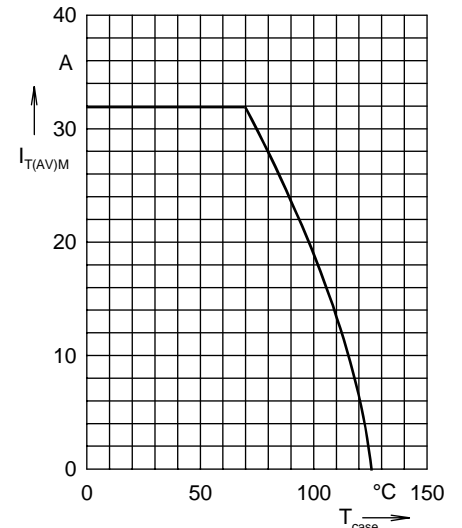

Fig. 6 Maximum forward current at case temperature 180° sine

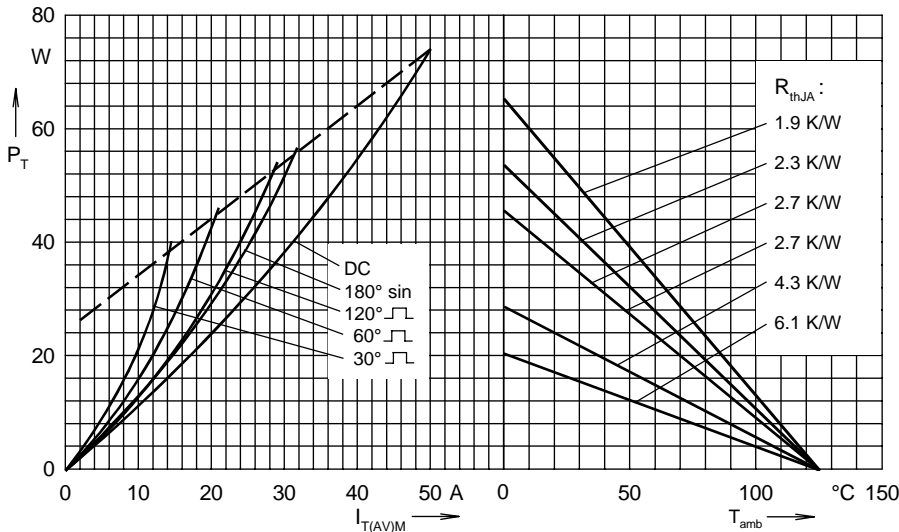

Fig. 7 Power dissipation versus on-state current and ambient temperature

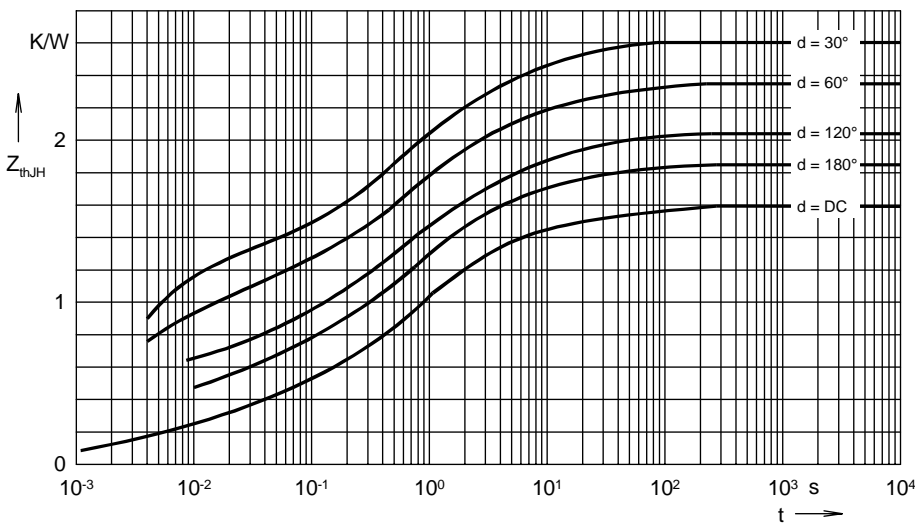

Fig. 8 Transient thermal impedance junction to heatsink

R_{thJH} for various conduction angles d:

d	R_{thJH} (K/W)
DC	1.61
180°	1.85
120°	2.03
60°	2.35
30°	2.60

Constants for Z_{thJH} calculation:

i	R_{thi} (K/W)	t_i (s)
1	0.224	0.003
2	0.132	0.028
3	0.321	0.216
4	0.522	1.1
5	0.249	4.2
6	0.162	43.2