

HiPerFRED²

High Performance Fast Recovery Diode
Low Loss and Soft Recovery
Single Diode

$V_{RRM} = 400\text{ V}$
 $I_{FAV} = 60\text{ A}$
 $t_{rr} = 60\text{ ns}$

Part number

DPF 60 IM 400 HB

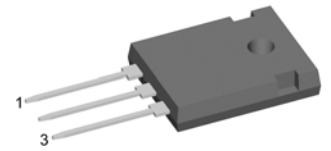
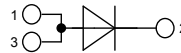

Backside: cathode

Features / Advantages:

- Planar passivated chips
- Very low leakage current
- Very short recovery time
- Improved thermal behaviour
- Very low I_{rm} -values
- Very soft recovery behaviour
- Avalanche voltage rated for reliable operation
- Soft reverse recovery for low EMI/RFI
- Low I_{rm} reduces:
 - Power dissipation within the diode
 - Turn-on loss in the commutating switch

Applications:

- Antiparallel diode for high frequency switching devices
- Antisaturation diode
- Snubber diode
- Free wheeling diode
- Rectifiers in switch mode power supplies (SMPS)
- Uninterruptible power supplies (UPS)

Package:

- Housing: TO-247
- Industry standard outline
- Epoxy meets UL 94V-0
- RoHS compliant

Ratings

Symbol	Definition	Conditions	Ratings			Unit
			min.	typ.	max.	
V_{RRM}	max. repetitive reverse voltage				400	V
I_R	reverse current	$V_R = 400\text{ V}$			1	μA
		$V_R = 400\text{ V}$			0.5	mA
V_F	forward voltage	$I_F = 60\text{ A}$			1.27	V
		$I_F = 120\text{ A}$			1.53	V
		$I_F = 60\text{ A}$			1.09	V
		$I_F = 120\text{ A}$			1.39	V
I_{FAV}	average forward current	rectangular $d = 0.5$			60	A
V_{F0}	threshold voltage	} for power loss calculation only			0.76	V
r_F	slope resistance				4.9	$\text{m}\Omega$
R_{thJC}	thermal resistance junction to case				0.55	K/W
T_{VJ}	virtual junction temperature		-55		175	$^{\circ}\text{C}$
P_{tot}	total power dissipation				275	W
I_{FSM}	max. forward surge current	$t = 10\text{ ms}$ (50 Hz), sine			600	A
I_{RM}	max. reverse recovery current				6	A
		$I_F = 60\text{ A}; V_R = 270\text{ V}$			12	A
t_{rr}	reverse recovery time	$-di_F/dt = 200\text{ A}/\mu\text{s}$			60	ns
					105	ns
C_J	junction capacitance	$V_R = 200\text{ V}; f = 1\text{ MHz}$			61	pF

Symbol	Definition	Conditions	Ratings			Unit
			min.	typ.	max.	
I_{RMS}	RMS current	per pin ¹⁾			70	A
R_{thCH}	thermal resistance case to heatsink			0.25		K/W
T_{stg}	storage temperature		-55		150	°C
Weight				6		g
M_D	mounting torque		0.8		1.2	Nm
F_C	mounting force with clip		20		120	N

¹⁾ I_{RMS} is typically limited by: 1. pin-to-chip resistance; or by 2. current capability of the chip.
 In case of 1, a common cathode/anode configuration and a non-isolated backside, the whole current capability can be used by connecting the backside.

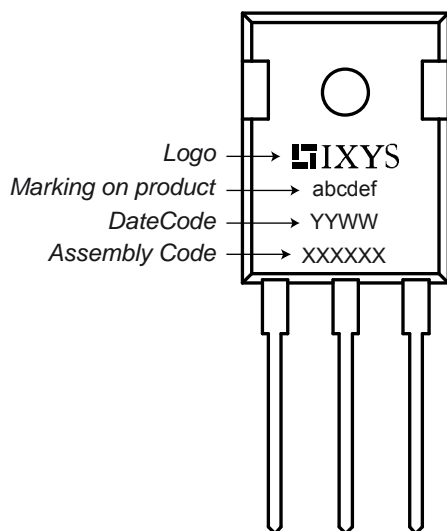
Product Marking

Part number

- D = Diode
- P = HiPerFRED
- F = ultra fast
- 60 = Current Rating [A]
- IM = Single Diode
- 400 = Reverse Voltage [V]
- HB = TO-247AD (3)

Ordering	Part Name	Marking on Product	Delivering Mode	Base Qty	Code Key
Standard	DPF 60 IM 400 HB	DPF60IM400HB	Tube	30	503573

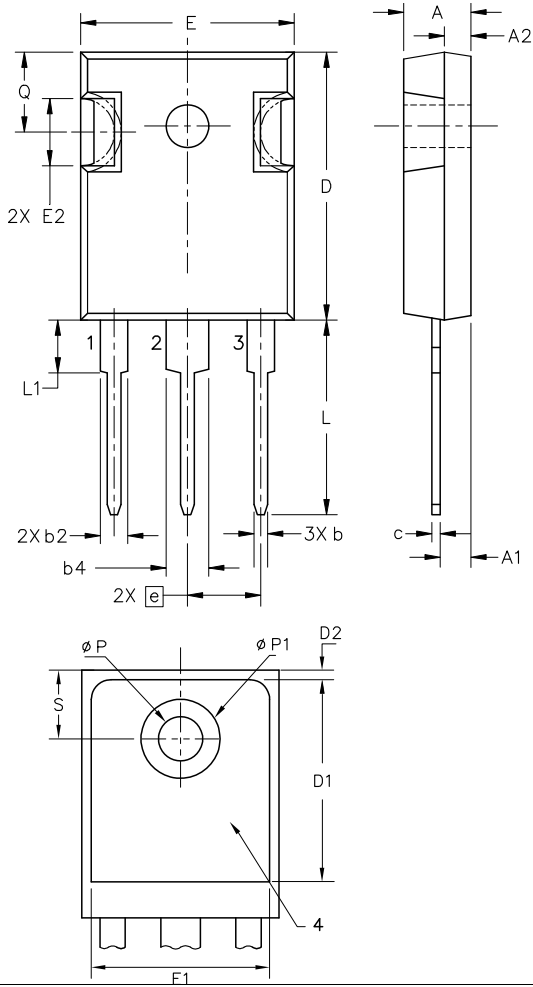
Similar Part	Package	Voltage Class
DPG60IM400QB	TO-3P (3)	400
DPG60I400HA	TO-247AD (2)	400

Outlines TO-247

Sym.	Inches		Millimeter	
	min.	max.	min.	max.
A	0.185	0.209	4.70	5.30
A1	0.087	0.102	2.21	2.59
A2	0.059	0.098	1.50	2.49
D	0.819	0.845	20.79	21.45
E	0.610	0.640	15.48	16.24
E2	0.170	0.216	4.31	5.48
e	0.215 BSC		5.46 BSC	
L	0.780	0.800	19.80	20.30
L1	-	0.177	-	4.49
ϕP	0.140	0.144	3.55	3.65
Q	0.212	0.244	5.38	6.19
S	0.242 BSC		6.14 BSC	
b	0.039	0.055	0.99	1.40
b2	0.065	0.094	1.65	2.39
b4	0.102	0.135	2.59	3.43
c	0.015	0.035	0.38	0.89
D1	0.515	-	13.07	-
D2	0.020	0.053	0.51	1.35
E1	0.530	-	13.45	-
$\phi P1$	-	0.29	-	7.39

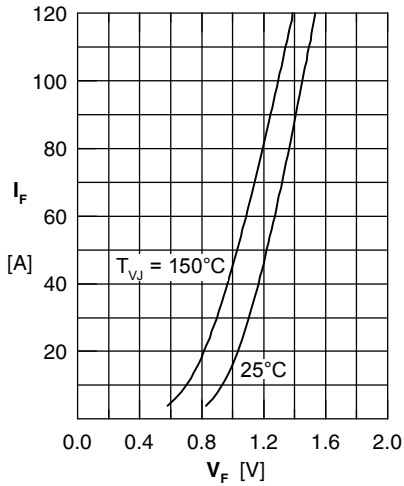

Fig. 1 Forward current I_F versus forward voltage V_F

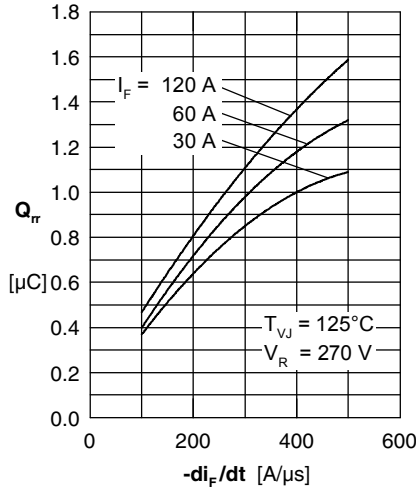

Fig. 2 Typ. reverse recovery charge Q_{rr} versus $-di_F/dt$

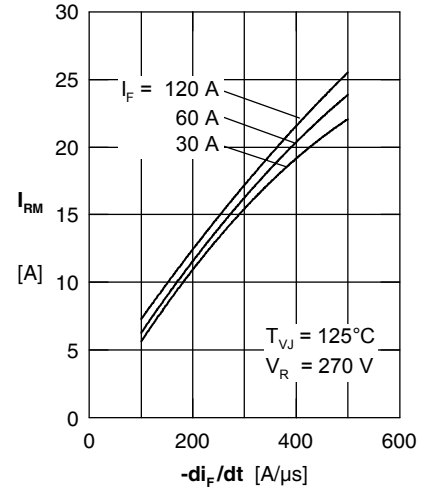

Fig. 3 Typ. reverse recovery current I_{RM} versus $-di_F/dt$

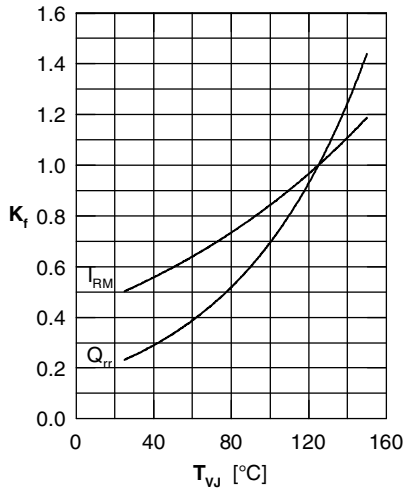

Fig. 4 Dynamic parameters Q_{rr} , I_{RM} versus T_{VJ}

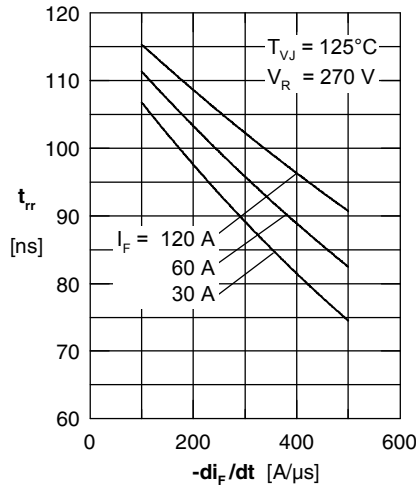

Fig. 5 Typ. reverse recovery time t_{rr} versus $-di_F/dt$

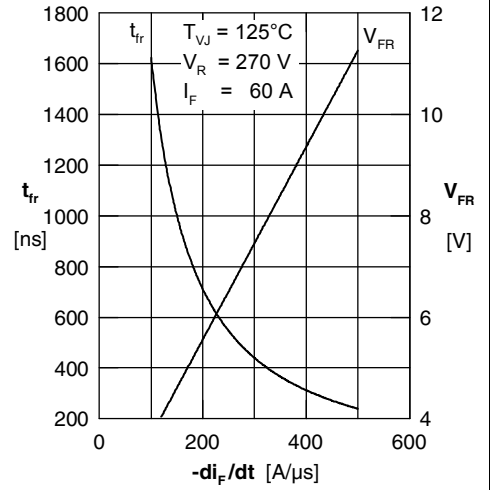

Fig. 6 Typ. forward recovery voltage V_{FR} & forward recovery time t_{fr} vs. di_F/dt

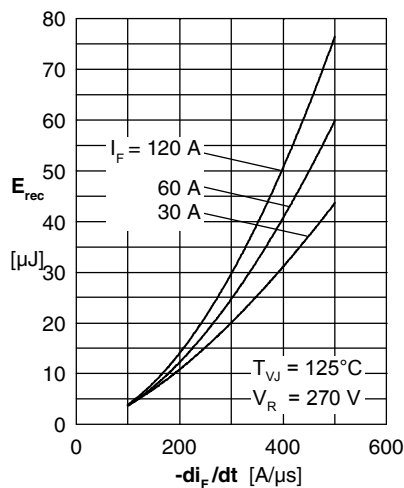

Fig. 7 Typ. recovery energy E_{rec} versus $-di_F/dt$

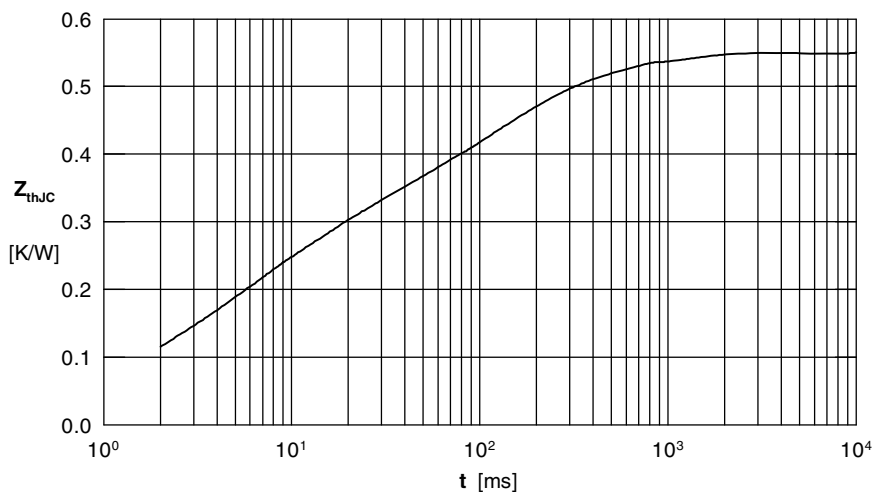

Fig. 8 Transient thermal impedance junction to case