

HiPerFRED²

High Performance Fast Recovery Diode
 Low Loss and Soft Recovery
 Single Diode

$V_{RRM} = 200\text{ V}$
 $I_{FAV} = 10\text{ A}$
 $t_{rr} = 35\text{ ns}$

Part number

DPG 10 I 200 PA

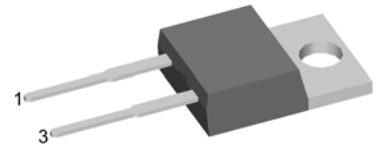
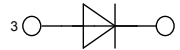

Backside: cathode

Features / Advantages:

- Planar passivated chips
- Very low leakage current
- Very short recovery time
- Improved thermal behaviour
- Very low I_{rm} -values
- Very soft recovery behaviour
- Avalanche voltage rated for reliable operation
- Soft reverse recovery for low EMI/RFI
- Low I_{rm} reduces:
 - Power dissipation within the diode
 - Turn-on loss in the commutating switch

Applications:

- Antiparallel diode for high frequency switching devices
- Antisaturation diode
- Snubber diode
- Free wheeling diode
- Rectifiers in switch mode power supplies (SMPS)
- Uninterruptible power supplies (UPS)

Package:

- Housing: TO-220
- Industry standard outline
- Epoxy meets UL 94V-0
- RoHS compliant

Ratings

Symbol	Definition	Conditions	Ratings			Unit	
			min.	typ.	max.		
V_{RRM}	max. repetitive reverse voltage				200	V	
I_R	reverse current	$V_R = 200\text{ V}$			1	μA	
		$V_R = 200\text{ V}$			0.06	mA	
V_F	forward voltage	$I_F = 10\text{ A}$			1.27	V	
		$I_F = 20\text{ A}$			1.45	V	
		$I_F = 10\text{ A}$	$T_{VJ} = 150^\circ\text{C}$			0.98	V
		$I_F = 20\text{ A}$	$T_{VJ} = 150^\circ\text{C}$			1.17	V
I_{FAV}	average forward current	rectangular $d = 0.5$			10	A	
V_{F0}	threshold voltage	} for power loss calculation only			0.74	V	
r_F	slope resistance				17.7	$\text{m}\Omega$	
R_{thJC}	thermal resistance junction to case				2.30	K/W	
T_{VJ}	virtual junction temperature		-55		175	$^\circ\text{C}$	
P_{tot}	total power dissipation				65	W	
I_{FSM}	max. forward surge current	$t = 10\text{ ms}$ (50 Hz), sine			140	A	
I_{RM}	max. reverse recovery current				3	A	
		$I_F = 10\text{ A}; V_R = 130\text{ V}$			5.5	A	
t_{rr}	reverse recovery time	$-di_F/dt = 200\text{ A}/\mu\text{s}$			35	ns	
					45	ns	
C_J	junction capacitance	$V_R = 150\text{ V}; f = 1\text{ MHz}$			15	pF	

Symbol	Definition	Conditions	Ratings			Unit
			min.	typ.	max.	
I_{RMS}	RMS current	per pin ¹⁾			35	A
R_{thCH}	thermal resistance case to heatsink			0.50		K/W
T_{stg}	storage temperature		-55		150	°C
Weight				2		g
M_D	mounting torque		0.4		0.6	Nm
F_C	mounting force with clip		20		60	N

¹⁾ I_{RMS} is typically limited by: 1. pin-to-chip resistance; or by 2. current capability of the chip.
 In case of 1, a common cathode/anode configuration and a non-isolated backside, the whole current capability can be used by connecting the backside.

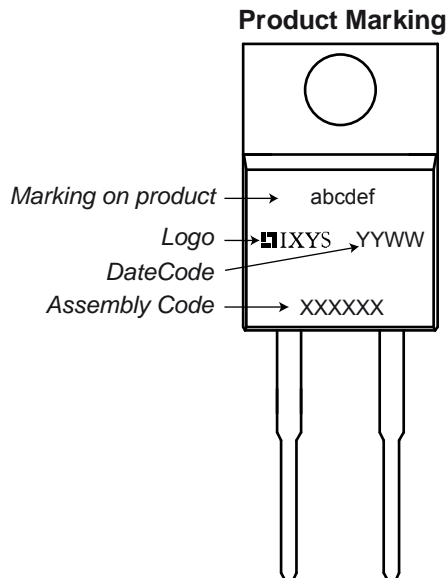
Part number

- D = Diode
- P = HiPerFRED
- G = extreme fast
- 10 = Current Rating [A]
- I = Single Diode
- 200 = Reverse Voltage [V]
- PA = TO-220AC (2)

Ordering	Part Name	Marking on Product	Delivering Mode	Base Qty	Code Key
Standard	DPG 10 I 200 PA	DPG10I200PA	Tube	50	506301

Similar Part	Package	Voltage Class
DPG10I200PM	TO-220ACFP (2)	200

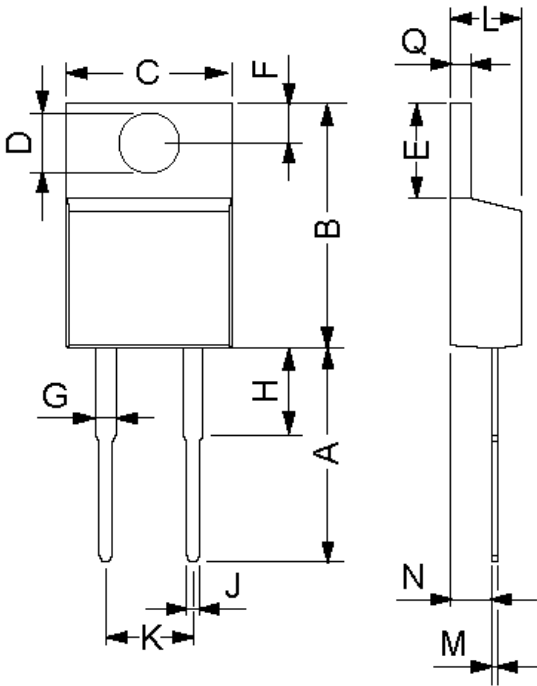
Outlines TO-220

Dim.	Millimeter		Inches	
	Min.	Max.	Min.	Max.
A	12.7	14.73	0.5	0.58
B	14.23	16.51	0.56	0.65
C	9.66	10.66	0.38	0.42
D	3.54	4.08	0.139	0.161
E	5.85	6.85	2.3	0.42
F	2.54	3.42	0.1	0.135
G	1.15	1.77	0.045	0.07
H	-	6.35	-	0.25
J	0.64	0.89	0.025	0.035
K	4.83	5.33	0.19	0.21
L	3.56	4.82	0.14	0.19
M	0.51	0.76	0.02	0.03
N	2.04	2.49	0.08	0.115
Q	0.64	1.39	0.025	0.055

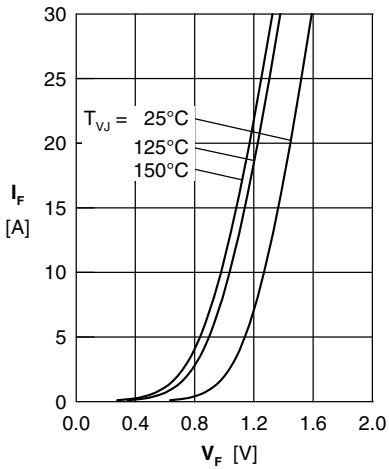

Fig. 1 Forward current I_F versus forward voltage drop V_F

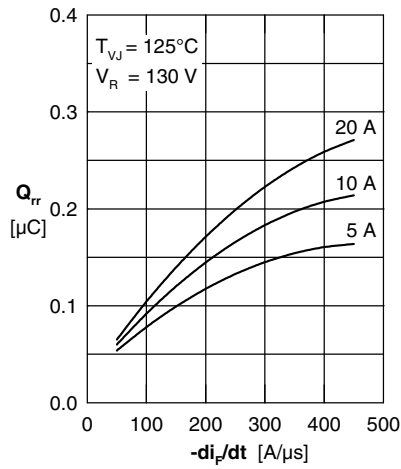

Fig. 2 Typ. reverse recovery charge Q_{rr} versus $-di_F/dt$

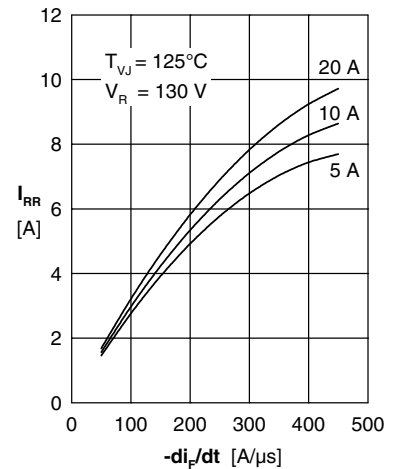

Fig. 3 Typ. reverse recovery current I_{RR} versus $-di_F/dt$

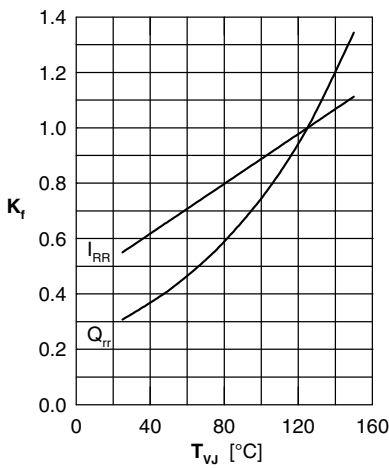

Fig. 4 Dynamic parameters Q_{rr} , I_{RR} versus T_{VJ}

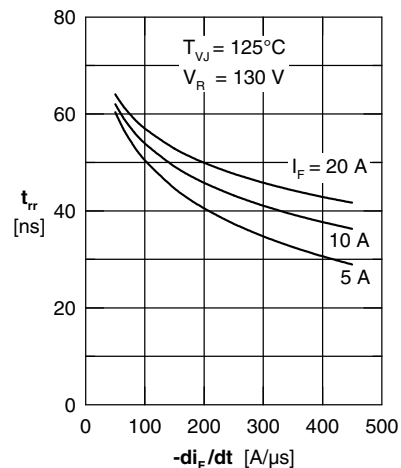

Fig. 5 Typ. reverse recovery time t_{tr} versus $-di_F/dt$

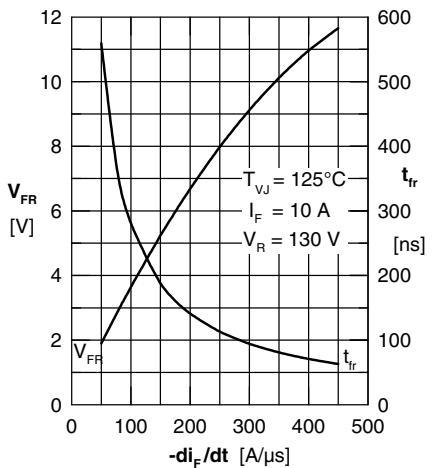

Fig. 6 Typ. forward recovery voltage V_{FR} and t_{tr} versus di_F/dt

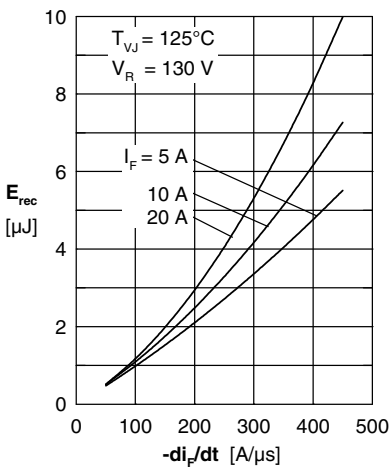

Fig. 7 Typ. recovery energy E_{rec} versus $-di_F/dt$

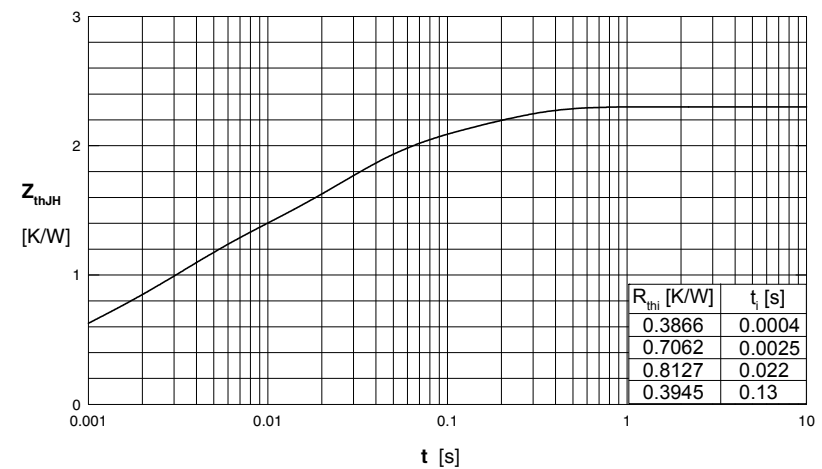

Fig. 8 Transient thermal resistance junction to case