

# HiPerFRED<sup>2</sup>

High Performance Fast Recovery Diode  
 Low Loss and Soft Recovery  
 Single Diode

Part number

**DPG 10 I 300 PA**

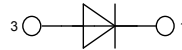

**V<sub>RRM</sub> = 300 V**  
**I<sub>FAV</sub> = 10 A**  
**t<sub>rr</sub> = 35 ns**

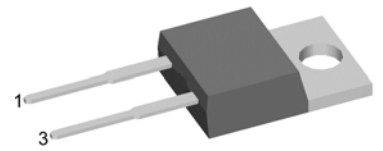

Backside: cathode

### Features / Advantages:

- Planar passivated chips
- Very low leakage current
- Very short recovery time
- Improved thermal behaviour
- Very low I<sub>rm</sub>-values
- Very soft recovery behaviour
- Avalanche voltage rated for reliable operation
- Soft reverse recovery for low EMI/RFI
- Low I<sub>rm</sub> reduces:
  - Power dissipation within the diode
  - Turn-on loss in the commutating switch

### Applications:

- Antiparallel diode for high frequency switching devices
- Antisaturation diode
- Snubber diode
- Free wheeling diode
- Rectifiers in switch mode power supplies (SMPS)
- Uninterruptible power supplies (UPS)

### Package:

- Housing: TO-220
- Industry standard outline
- Epoxy meets UL 94V-0
- RoHS compliant

### Ratings

Symbol	Definition	Conditions	Ratings			Unit	
			min.	typ.	max.		
V <sub>RRM</sub>	max. repetitive reverse voltage	T <sub>VJ</sub> = 25°C			300	V	
I <sub>R</sub>	reverse current	V <sub>R</sub> = 300V			1	μA	
		V <sub>R</sub> = 300V			0.06	mA	
V <sub>F</sub>	forward voltage	I <sub>F</sub> = 10A			1.27	V	
		I <sub>F</sub> = 20A			1.45	V	
		I <sub>F</sub> = 10A	T <sub>VJ</sub> = 150°C			0.98	V
						1.17	V
I <sub>FAV</sub>	average forward current	rectangular d = 0.5			10	A	
V <sub>F0</sub>	threshold voltage	} for power loss calculation only			0.74	V	
r <sub>F</sub>	slope resistance				17.7	mΩ	
R <sub>thJC</sub>	thermal resistance junction to case				2.30	K/W	
T <sub>VJ</sub>	virtual junction temperature		-55		175	°C	
P <sub>tot</sub>	total power dissipation	T <sub>C</sub> = 25°C			65	W	
I <sub>FSM</sub>	max. forward surge current	t = 10 ms (50 Hz), sine			140	A	
I <sub>RM</sub>	max. reverse recovery current				3	A	
		I <sub>F</sub> = 10 A; V <sub>R</sub> = 200 V			5.5	A	
t <sub>rr</sub>	reverse recovery time	-di <sub>F</sub> /dt = 200 A/μs			35	ns	
					45	ns	
C <sub>J</sub>	junction capacitance	V <sub>R</sub> = 150 V; f = 1 MHz			15	pF	

Symbol	Definition	Conditions	Ratings			Unit
			min.	typ.	max.	
$I_{RMS}$	RMS current	per pin <sup>1)</sup>			35	A
$R_{thCH}$	thermal resistance case to heatsink			0.50		K/W
$T_{stg}$	storage temperature		-55		150	°C
<b>Weight</b>				2		g
$M_D$	mounting torque		0.4		0.6	Nm
$F_C$	mounting force with clip		20		60	N

<sup>1)</sup>  $I_{RMS}$  is typically limited by: 1. pin-to-chip resistance; or by 2. current capability of the chip.  
 In case of 1, a common cathode/anode configuration and a non-isolated backside, the whole current capability can be used by connecting the backside.

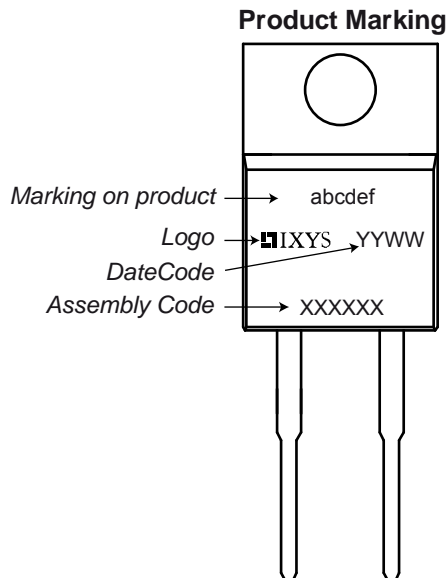
**Part number**

- D = Diode
- P = HiPerFRED
- G = extreme fast
- 10 = Current Rating [A]
- I = Single Diode
- 300 = Reverse Voltage [V]
- PA = TO-220AC (2)

Ordering	Part Name	Marking on Product	Delivering Mode	Base Qty	Code Key
Standard	DPG 10 I 300 PA	DPG10I300PA	Tube	50	506640

Similar Part	Package	Voltage Class
DPG10IM300UC	TO-252AA (DPak)	300

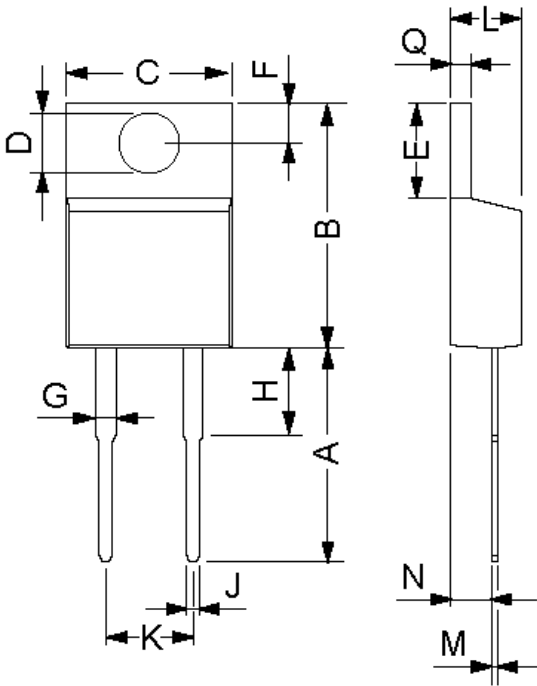
**Outlines TO-220**

Dim.	Millimeter		Inches	
	Min.	Max.	Min.	Max.
A	12.7	14.73	0.5	0.58
B	14.23	16.51	0.56	0.65
C	9.66	10.66	0.38	0.42
D	3.54	4.08	0.139	0.161
E	5.85	6.85	2.3	0.42
F	2.54	3.42	0.1	0.135
G	1.15	1.77	0.045	0.07
H	-	6.35	-	0.25
J	0.64	0.89	0.025	0.035
K	4.83	5.33	0.19	0.21
L	3.56	4.82	0.14	0.19
M	0.51	0.76	0.02	0.03
N	2.04	2.49	0.08	0.115
Q	0.64	1.39	0.025	0.055

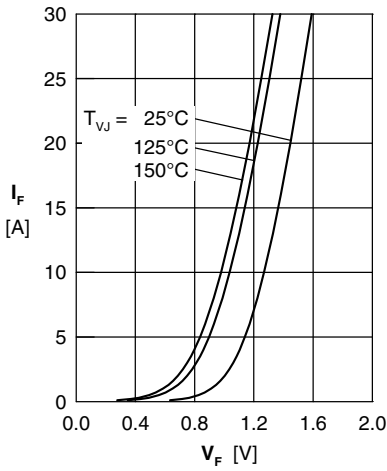

Fig. 1 Forward current  $I_F$  versus forward voltage drop  $V_F$

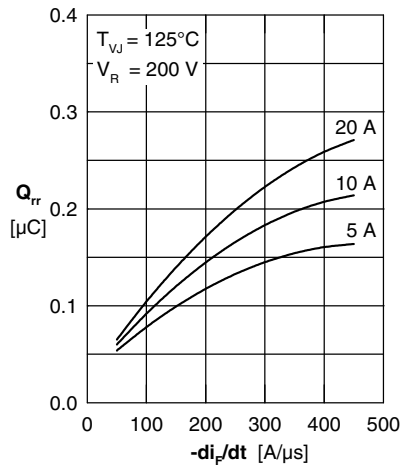

Fig. 2 Typ. reverse recovery charge  $Q_{rr}$  versus  $-di_F/dt$

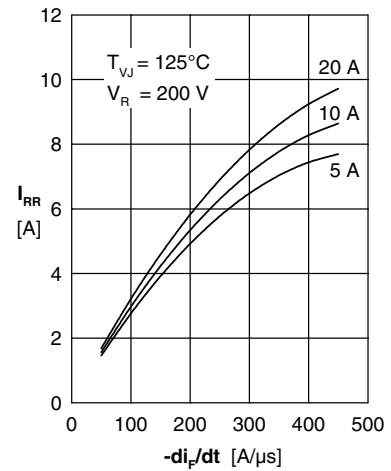

Fig. 3 Typ. reverse recovery current  $I_{RR}$  versus  $-di_F/dt$

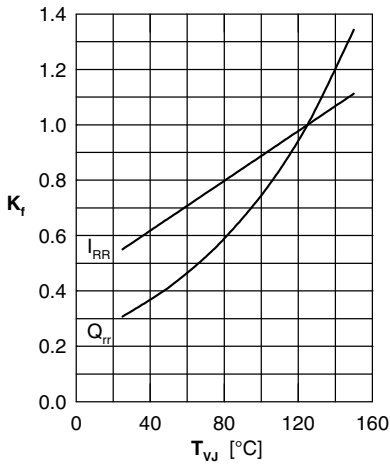

Fig. 4 Dynamic parameters  $Q_{rr}$ ,  $I_{RR}$  versus  $T_{VJ}$

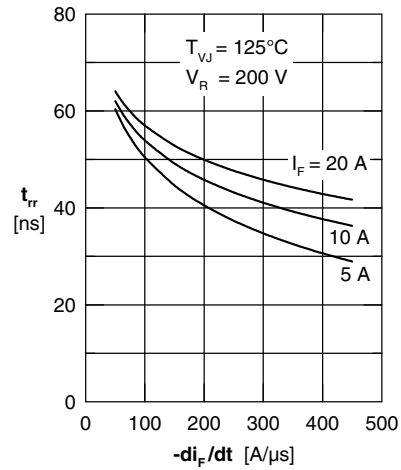

Fig. 5 Typ. reverse recovery time  $t_{tr}$  versus  $-di_F/dt$

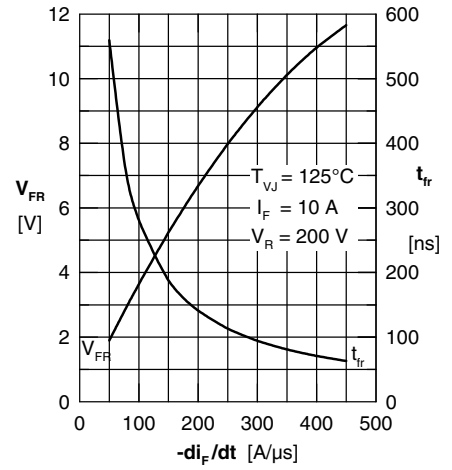

Fig. 6 Typ. forward recovery voltage  $V_{FR}$  and  $t_{tr}$  versus  $di_F/dt$

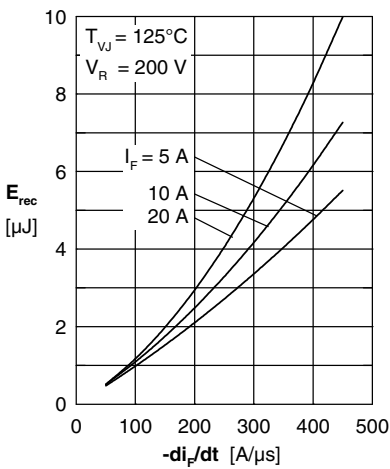

Fig. 7 Typ. recovery energy  $E_{rec}$  versus  $-di_F/dt$

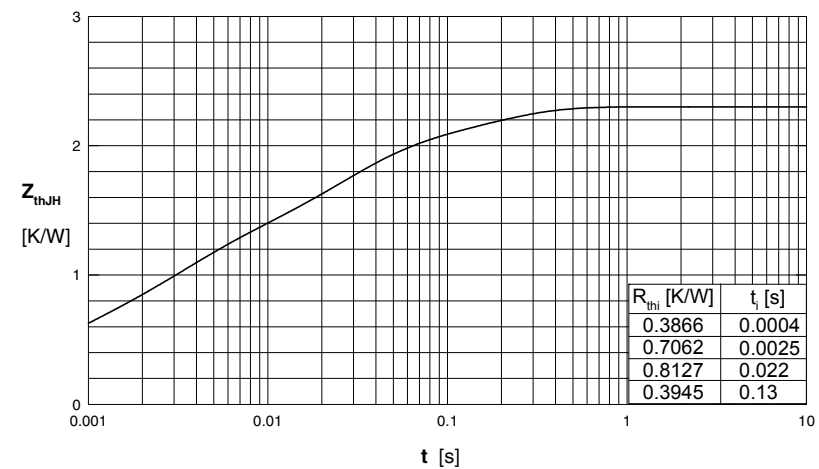

Fig. 8 Transient thermal resistance junction to case