

HiPerFRED²

High Performance Fast Recovery Diode
 Low Loss and Soft Recovery
 Common Cathode

$V_{RRM} = 200\text{ V}$
 $I_{FAV} = 2x\ 15\text{ A}$
 $t_{rr} = 35\text{ ns}$

Part number

DPG 30 C 200 PC

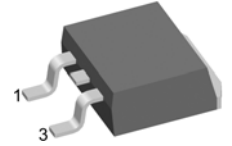
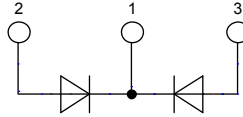

Backside: cathode

Features / Advantages:

- Planar passivated chips
- Very low leakage current
- Very short recovery time
- Improved thermal behaviour
- Very low I_{rm} -values
- Very soft recovery behaviour
- Avalanche voltage rated for reliable operation
- Soft reverse recovery for low EMI/RFI
- Low I_{rm} reduces:
 - Power dissipation within the diode
 - Turn-on loss in the commutating switch

Applications:

- Antiparallel diode for high frequency switching devices
- Antisaturation diode
- Snubber diode
- Free wheeling diode
- Rectifiers in switch mode power supplies (SMPS)
- Uninterruptible power supplies (UPS)

Package:

- Housing: TO-263 (D2Pak)
- Industry standard outline
- Epoxy meets UL 94V-0
- RoHS compliant

Ratings

Symbol	Definition	Conditions	Ratings			Unit	
			min.	typ.	max.		
V_{RRM}	max. repetitive reverse voltage				200	V	
I_R	reverse current	$V_R = 200\text{ V}$			1	μA	
		$V_R = 200\text{ V}$			0.08	mA	
V_F	forward voltage	$I_F = 15\text{ A}$			1.26	V	
		$I_F = 30\text{ A}$			1.51	V	
		$I_F = 15\text{ A}$	$T_{VJ} = 150^\circ\text{C}$			1.01	V
		$I_F = 30\text{ A}$	$T_{VJ} = 150^\circ\text{C}$			1.29	V
I_{FAV}	average forward current	rectangular $d = 0.5$			15	A	
V_{F0}	threshold voltage	} for power loss calculation only			0.69	V	
r_F	slope resistance				18	m Ω	
R_{thJC}	thermal resistance junction to case				1.70	K/W	
T_{VJ}	virtual junction temperature		-55		175	$^\circ\text{C}$	
P_{tot}	total power dissipation				90	W	
I_{FSM}	max. forward surge current	$t = 10\text{ ms}$ (50 Hz), sine			240	A	
I_{RM}	max. reverse recovery current				3	A	
		$I_F = 15\text{ A}; V_R = 130\text{ V}$			6.5	A	
t_{rr}	reverse recovery time	$-di_F/dt = 130\text{ A}/\mu\text{s}$			35	ns	
					55	ns	
C_J	junction capacitance	$V_R = 150\text{ V}; f = 1\text{ MHz}$			20	pF	

Symbol	Definition	Conditions	Ratings			Unit
			min.	typ.	max.	
I_{RMS}	RMS current	per terminal			35	A
R_{thCH}	thermal resistance case to heatsink			0.25		K/W
T_{stg}	storage temperature		-55		150	°C
Weight				2		g
F_c	mounting force with clip		20		60	N

Product Marking

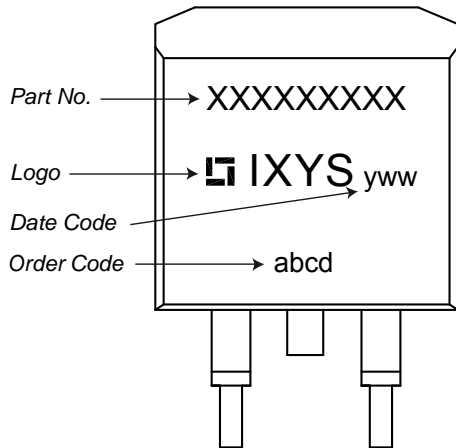

Part number

- D = Diode
- P = HiPerFRED
- G = extreme fast
- 30 = Current Rating [A]
- C = Common Cathode
- 200 = Reverse Voltage [V]
- PC = TO-263AB (D2Pak) (2)

Ordering	Part Name	Marking on Product	Delivering Mode	Base Qty	Code Key
Standard	DPG 30 C 200 PC	DPG30C200PC	Tape & Reel	800	506675

Similar Part	Package	Voltage Class
DPG30C200PB	TO-220AB (3)	200
DPG30C200HB	TO-247AD (3)	200

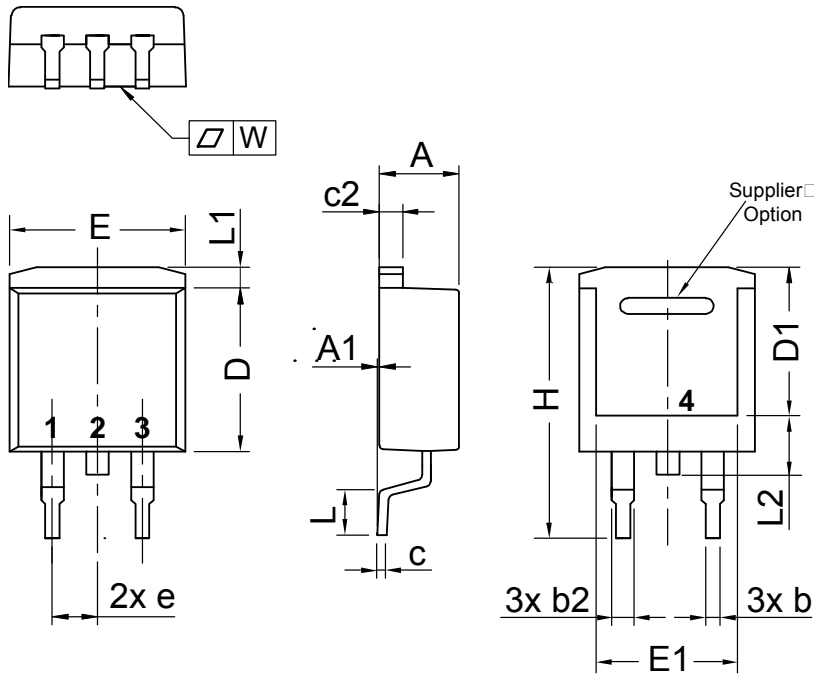
Outlines TO-263 (D2Pak)

Dim.	Millimeter		Inches	
	min	max	min	max
A	4.06	4.83	0.160	0.190
A1	typ. 0.10		typ. 0.004	
b	0.51	0.99	0.020	0.039
b2	1.14	1.40	0.045	0.055
c	0.40	0.74	0.016	0.029
c2	1.14	1.40	0.045	0.029
D	8.38	9.40	0.330	0.370
D1	8.00	8.89	0.315	0.350
E	9.65	10.41	0.380	0.410
E1	6.22	8.20	0.245	0.323
e	2,54 BSC		0,100 BSC	
H	14.61	15.88	0.575	0.625
L	1.78	2.79	0.070	0.110
L1	1.02	1.68	0.040	0.066
L2	1.02	1.52	0.040	0.060
W	typ. 0.02	0.040	typ. 0.0008	0.0016

All dimensions conform with and/or are within JEDEC standard.

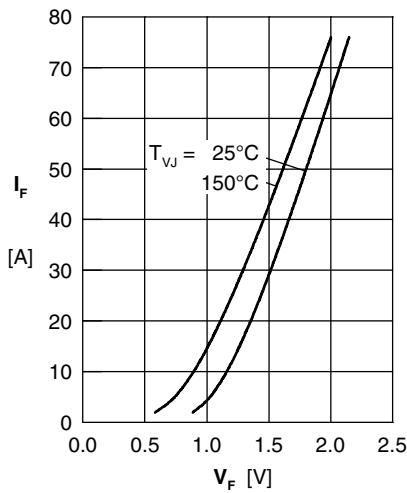

Fig. 1 Forward current I_F vs. V_F

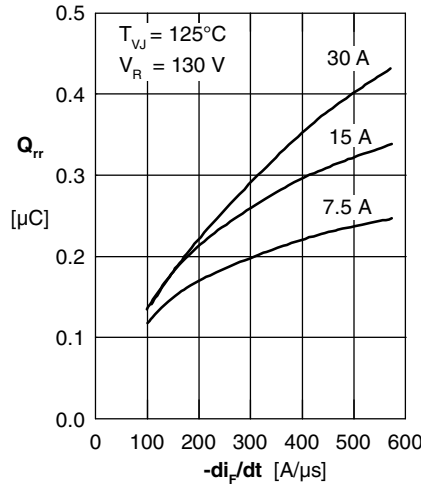

Fig. 2 Typ. reverse recovery charge Q_{rr} versus $-di_F/dt$

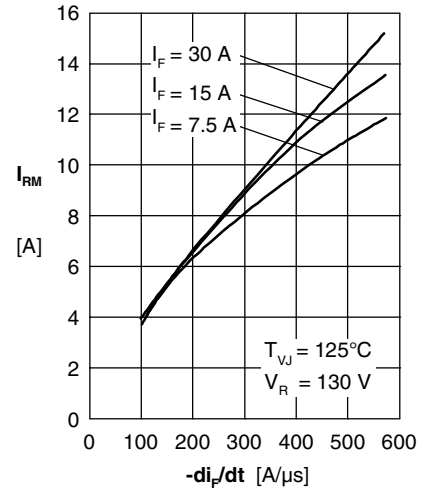

Fig. 3 Typ. peak reverse current I_{RM} versus $-di_F/dt$

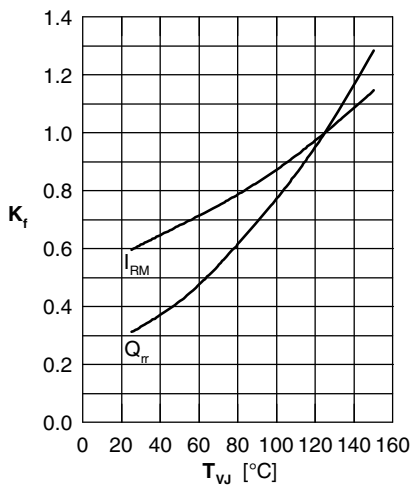

Fig. 4 Dynamic parameters Q_{rr} , I_{RM} versus T_{VJ}

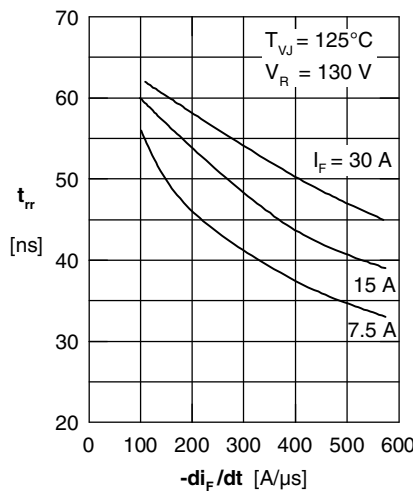

Fig. 5 Typ. recovery time t_{rr} vs. $-di_F/dt$

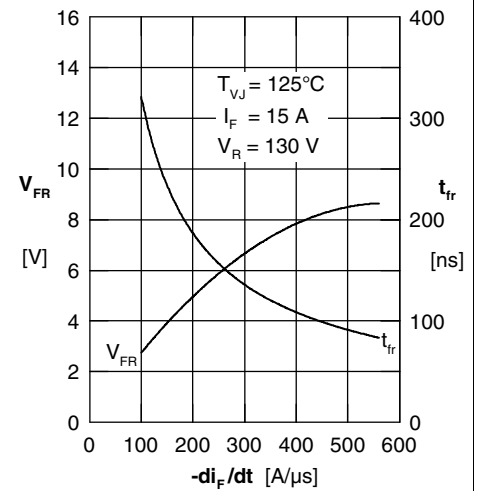

Fig. 6 Typ. peak forward voltage V_{FR} and t_{rr} versus di_F/dt

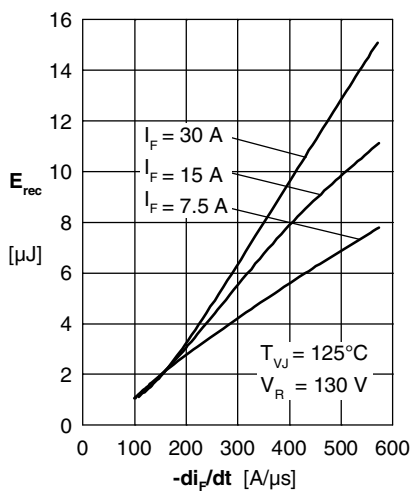

Fig. 7 Typ. recovery energy E_{rec} versus $-di_F/dt$

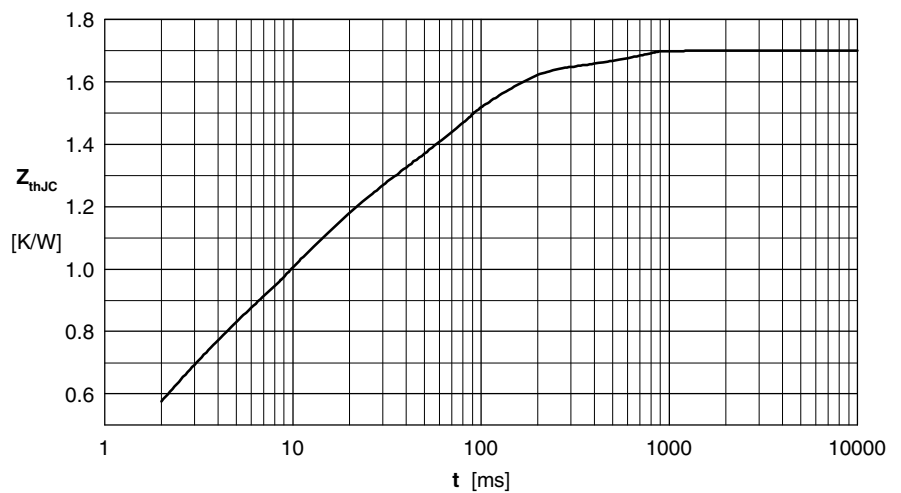

Fig. 8 Transient thermal resistance junction to case