

# HiPerFRED<sup>2</sup>

High Performance Fast Recovery Diode  
 Low Loss and Soft Recovery  
 Common Cathode

$V_{RRM} = 400\text{ V}$   
 $I_{FAV} = 2 \times 15\text{ A}$   
 $t_{rr} = 45\text{ ns}$

Part number

**DPG 30 C 400 PB**

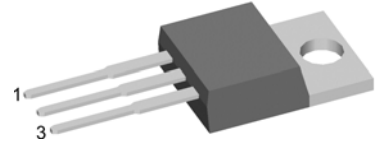
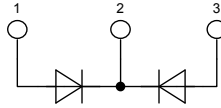

Backside: cathode

### Features / Advantages:

- Planar passivated chips
- Very low leakage current
- Very short recovery time
- Improved thermal behaviour
- Very low  $I_{rm}$ -values
- Very soft recovery behaviour
- Avalanche voltage rated for reliable operation
- Soft reverse recovery for low EMI/RFI
- Low  $I_{rm}$  reduces:
  - Power dissipation within the diode
  - Turn-on loss in the commutating switch

### Applications:

- Antiparallel diode for high frequency switching devices
- Antisaturation diode
- Snubber diode
- Free wheeling diode
- Rectifiers in switch mode power supplies (SMPS)
- Uninterruptible power supplies (UPS)

### Package:

- Housing: TO-220
- Industry standard outline
- Epoxy meets UL 94V-0
- RoHS compliant

### Ratings

Symbol	Definition	Conditions	Ratings			Unit	
			min.	typ.	max.		
$V_{RRM}$	max. repetitive reverse voltage				400	V	
$I_R$	reverse current	$V_R = 400\text{ V}$			1	$\mu\text{A}$	
		$V_R = 400\text{ V}$			0.18	mA	
$V_F$	forward voltage	$I_F = 15\text{ A}$			1.39	V	
		$I_F = 30\text{ A}$			1.63	V	
		$I_F = 15\text{ A}$	$T_{VJ} = 150^\circ\text{C}$			1.14	V
		$I_F = 30\text{ A}$	$T_{VJ} = 150^\circ\text{C}$			1.40	V
$I_{FAV}$	average forward current	rectangular d = 0.5			15	A	
$V_{F0}$	threshold voltage	} for power loss calculation only			0.84	V	
$r_F$	slope resistance				16.5	m $\Omega$	
$R_{thJC}$	thermal resistance junction to case				1.70	K/W	
$T_{VJ}$	virtual junction temperature		-55		175	$^\circ\text{C}$	
$P_{tot}$	total power dissipation				90	W	
$I_{FSM}$	max. forward surge current	t = 10 ms (50 Hz), sine			190	A	
$I_{RM}$	max. reverse recovery current				4	A	
		$I_F = 15\text{ A}; V_R = 270\text{ V}$			5.5	A	
$t_{rr}$	reverse recovery time	$-di_F/dt = 200\text{ A}/\mu\text{s}$			45	ns	
					70	ns	
$C_J$	junction capacitance	$V_R = 200\text{ V}; f = 1\text{ MHz}$			16	pF	

Symbol	Definition	Conditions	Ratings			Unit
			min.	typ.	max.	
$I_{RMS}$	RMS current	per pin <sup>1)</sup>			35	A
$R_{thCH}$	thermal resistance case to heatsink			0.50		K/W
$T_{stg}$	storage temperature		-55		150	°C
<b>Weight</b>				2		g
$M_D$	mounting torque		0.4		0.6	Nm
$F_C$	mounting force with clip		20		60	N

<sup>1)</sup>  $I_{RMS}$  is typically limited by: 1. pin-to-chip resistance; or by 2. current capability of the chip.  
 In case of 1, a common cathode/anode configuration and a non-isolated backside, the whole current capability can be used by connecting the backside.

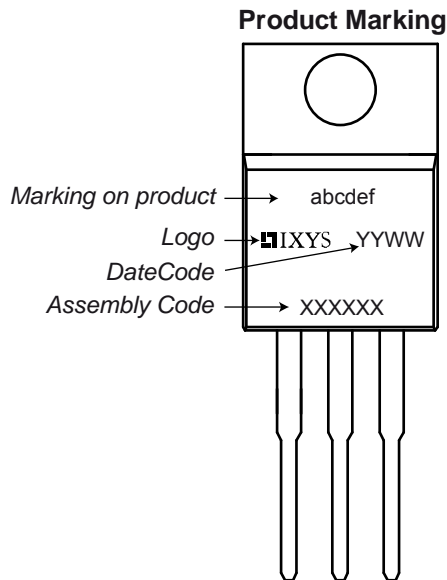
**Part number**

- D = Diode
- P = HiPerFRED
- G = extreme fast
- 30 = Current Rating [A]
- C = Common Cathode
- 400 = Reverse Voltage [V]
- PB = TO-220AB (3)

Ordering	Part Name	Marking on Product	Delivering Mode	Base Qty	Code Key
Standard	DPG 30 C 400 PB	DPG30C400PB	Tube	50	507157

Similar Part	Package	Voltage Class
DPG30C400HB	TO-247AD (3)	400

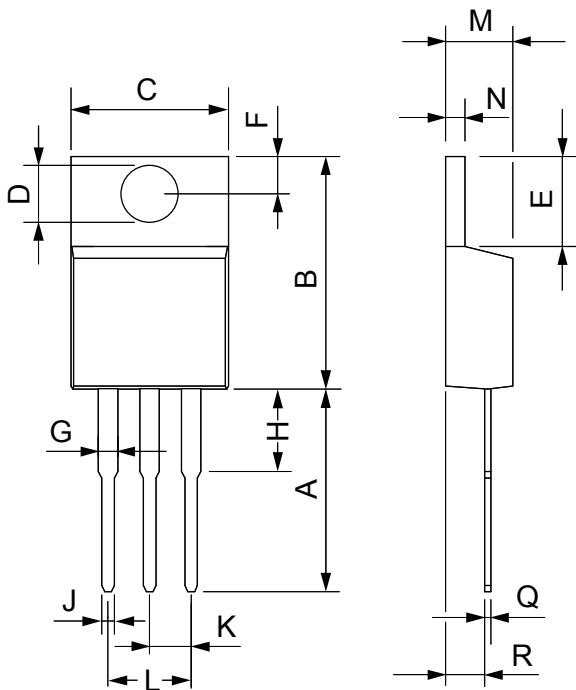
**Outlines TO-220**

Dim.	Millimeter		Inches	
	Min.	Max.	Min.	Max.
A	12.70	13.97	0.500	0.550
B	14.73	16.00	0.580	0.630
C	9.91	10.66	0.390	0.420
D	3.54	4.08	0.139	0.161
E	5.85	6.85	0.230	0.270
F	2.54	3.18	0.100	0.125
G	1.15	1.65	0.045	0.065
H	2.79	5.84	0.110	0.230
J	0.64	1.01	0.025	0.040
K	2.54	BSC	0.100	BSC
M	4.32	4.82	0.170	0.190
N	1.14	1.39	0.045	0.055
Q	0.35	0.56	0.014	0.022
R	2.29	2.79	0.090	0.110

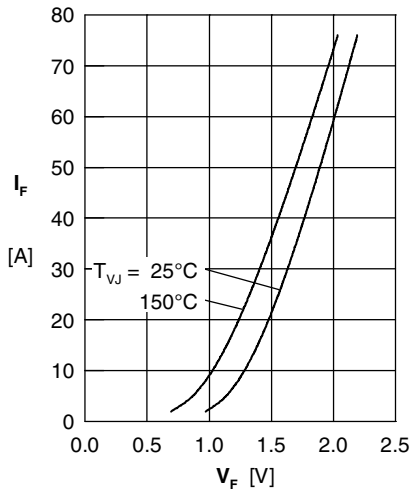

Fig. 1 Forward current  $I_F$  vs.  $V_F$

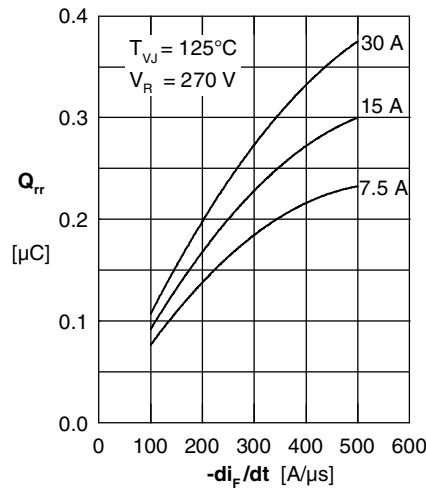

Fig. 2 Typ. reverse recovery charge  $Q_{rr}$  versus  $-di_F/dt$

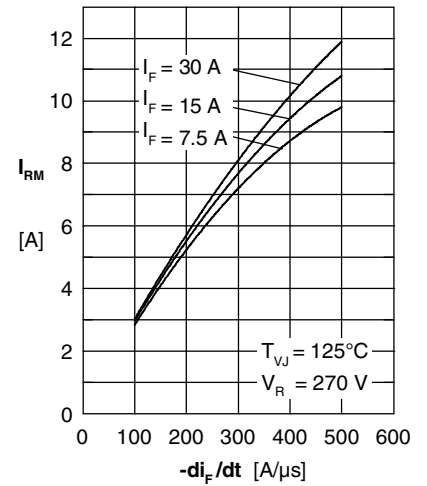

Fig. 3 Typ. peak reverse current  $I_{RM}$  versus  $-di_F/dt$

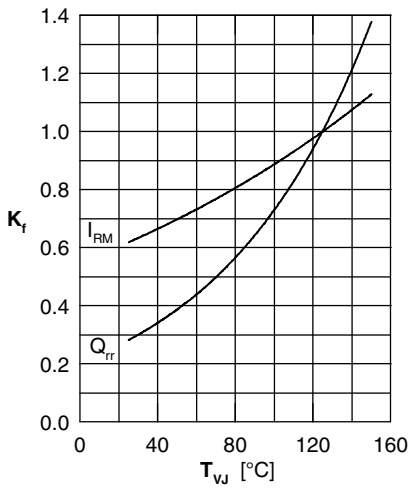

Fig. 4 Dynamic parameters  $Q_{rr}$ ,  $I_{RM}$  versus  $T_{VJ}$

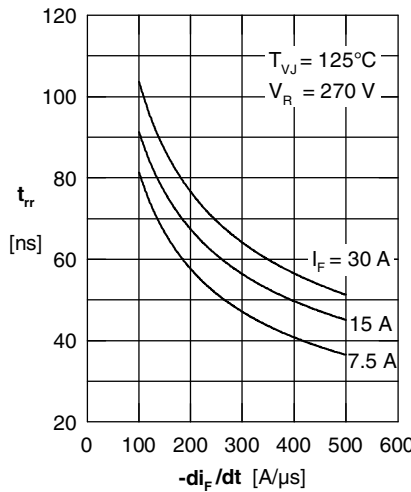

Fig. 5 Typ. recovery time  $t_{rr}$  vs.  $-di_F/dt$

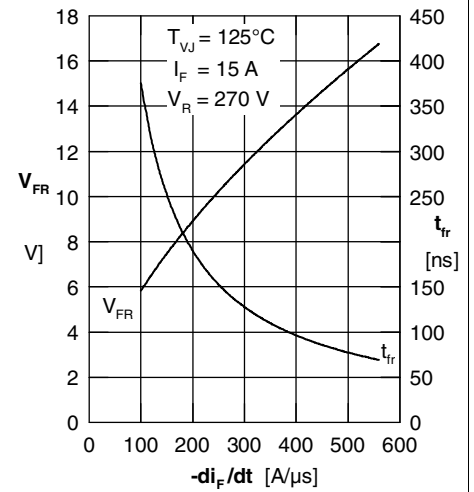

Fig. 6 Typ. peak forward voltage  $V_{FR}$  and  $t_{rr}$  versus  $di_F/dt$

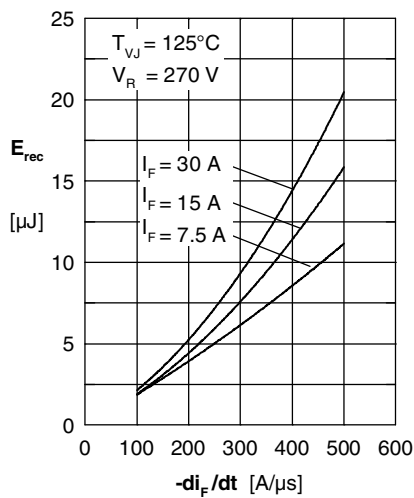

Fig. 7 Typ. recovery energy  $E_{rec}$  versus  $-di_F/dt$

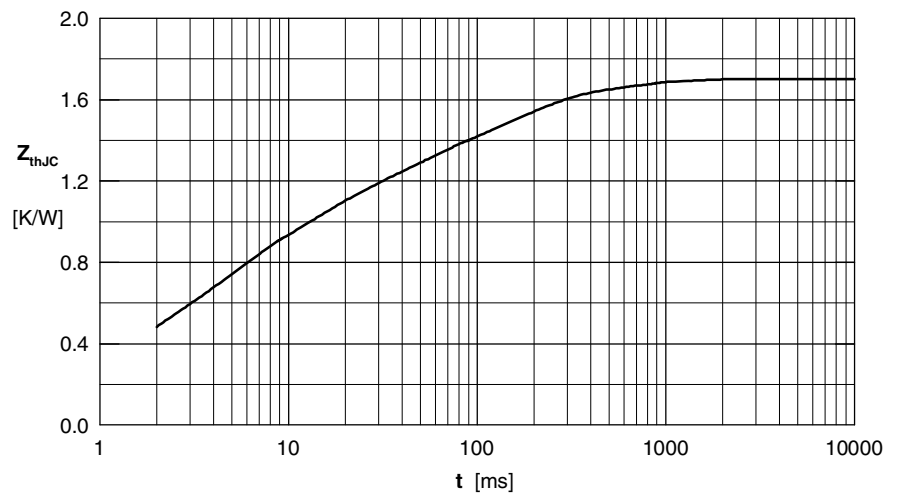

Fig. 8 Transient thermal resistance junction to case