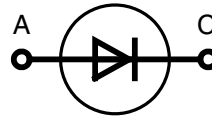

# Avalanche Diode

$V_{RRM} = 1200-1800\text{ V}$   
 $I_{F(RMS)} = 18\text{ A}$   
 $I_{FAVM} = 11\text{ A}$

$V_{RSM}$	$V_{(BR)min}$	$V_{RRM}$	Type
V	V	V	
1300	1300	1200	DSA 9-12F
1700	1750	1600	DSA 9-16F
1900	1950	1800	DSA 9-18F

**DO-203 AA**

A = Anode, C = Cathode

Symbol	Conditions	Maximum Ratings	
$I_{FRMS}$	$T_{VJ} = T_{VJM}$	18	A
$I_{FAVM}$	$T_C = 150^\circ\text{C}; 180^\circ\text{ sine}$	11	A
$P_{RSM}$	$T_{VJM}, t_p = 10\text{ ms}$	4.5	kW
$I_{FSM}$	$T_{VJ} = 45^\circ\text{C};$ $t = 10\text{ ms (50 Hz), sine}$ $t = 8.3\text{ ms (60 Hz), sine}$	250	A
		265	
$I^2t$	$T_{VJ} = 150^\circ\text{C};$ $t = 10\text{ ms (50 Hz), sine}$ $t = 8.3\text{ ms (60 Hz), sine}$	200	A
		220	
$I^2t$	$T_{VJ} = 45^\circ\text{C};$ $t = 10\text{ ms (50 Hz), sine}$ $t = 8.3\text{ ms (60 Hz), sine}$	310	A <sup>2</sup> s
		295	
$I^2t$	$T_{VJ} = 150^\circ\text{C};$ $t = 10\text{ ms (50 Hz), sine}$ $t = 8.3\text{ ms (60 Hz), sine}$	200	A <sup>2</sup> s
		190	
$T_{VJ}$		-40...+180	°C
$T_{VJM}$		180	°C
$T_{stg}$		-40...+180	°C
$M_d$	mounting torque	2.2...2.8	Nm
<b>Weight</b>	typical	5	g

**Features**

- International standard package JEDEC DO-203 AA
- Planar passivated chips

**Applications**

- Supplies for DC power equipment
- DC supply for PWM inverter
- Field supply for DC motors
- Battery DC power supplies

**Advantages**

- Space and weight savings
- Simple mounting
- Improved temperature & power cycling
- Reduced protection circuits

Dimensions in mm (1 mm = 0.0394")

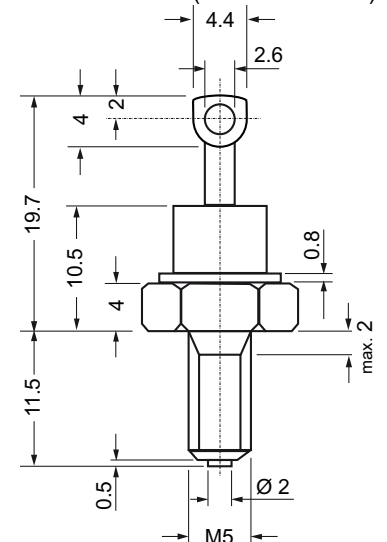

Symbol	Conditions	Characteristic Values		
		typ.	max.	
$I_R$	$V_R = V_{RRM}$ $T_{VJ} = T_{VJM}$		3	mA
$V_F$	$I_F = 36\text{ A}$ $T_{VJ} = 25^\circ\text{C}$		1.4	V
$V_{T0}$	For power-loss calculations only		0.85	V
$r_T$	$T_{VJ} = T_{VJM}$		15	mΩ
$R_{thJC}$	DC current		2	K/W
	180° sine		2.17	K/W
$R_{thJH}$	DC current		3.0	K/W
$d_s$	Creepage distance on surface		2.0	mm
$d_A$	Strike distance through air		2.0	mm
$a$	Max. allowable acceleration		100	m/s <sup>2</sup>

Data according to IEC 60747

IXYS reserves the right to change limits, test conditions and dimensions.

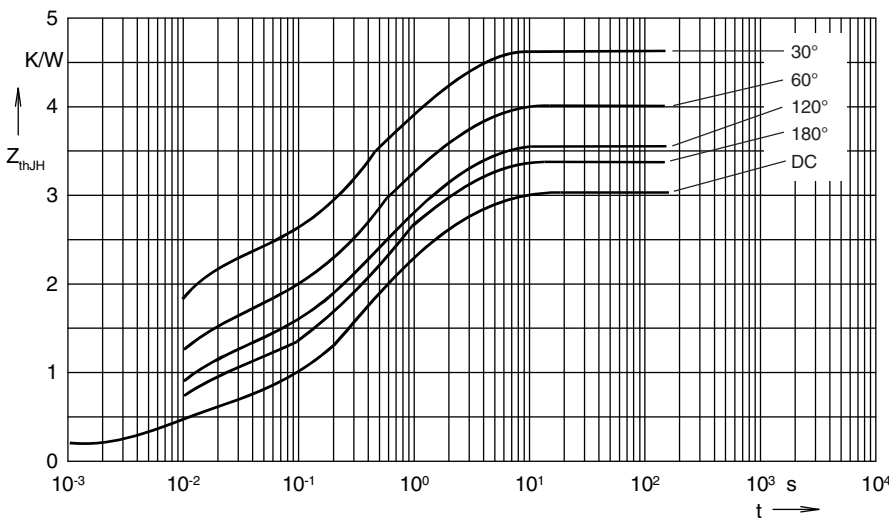
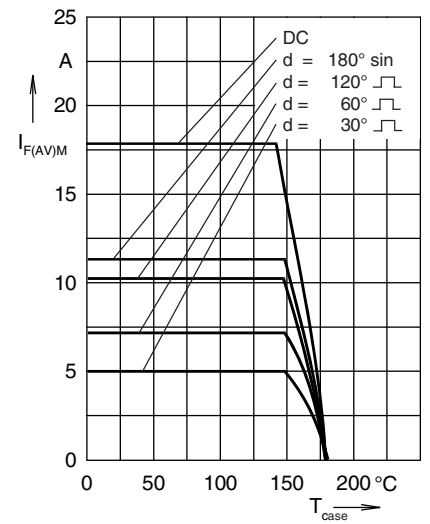
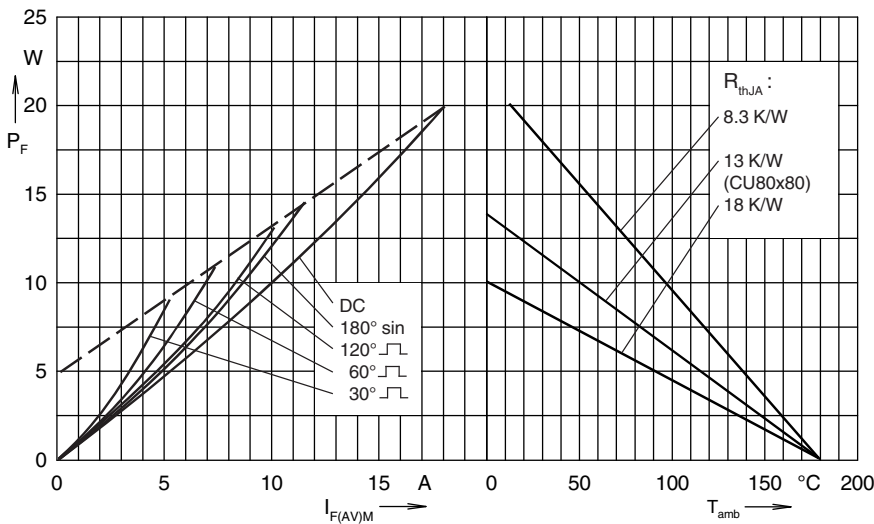
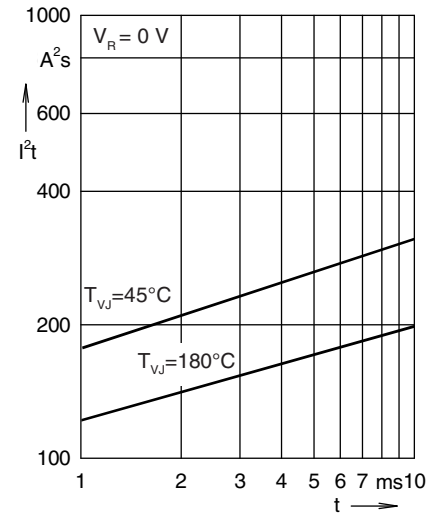
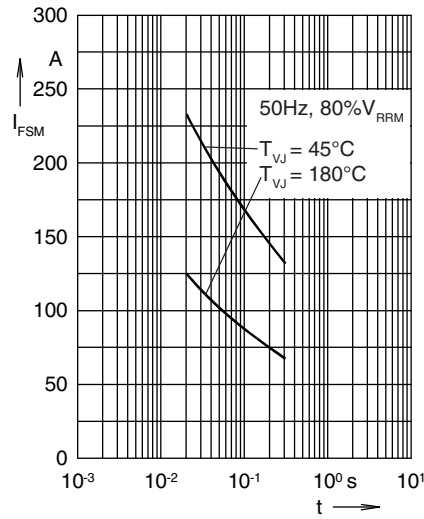
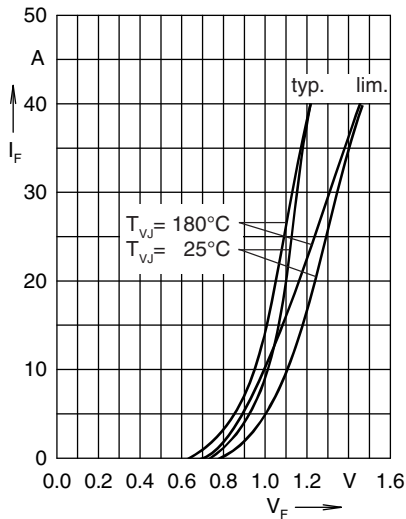

$R_{thJH}$  for various conduction angles  $d$ :

$d$	$R_{thJH}$ (K/W)
DC	3.0
180°	3.35
120°	3.56
60°	4.0
30°	4.64

Constants for  $Z_{thJH}$  calculation:

$i$	$R_{thi}$ (K/W)	$t_i$ (s)
1	0.095	0.00032
2	0.515	0.0102
3	1.39	0.360
4	1.0	2.30