

# Schottky Diode

High Performance Schottky Diode  
Low Loss and Soft Recovery  
Single Diode

Part number

**DSS25-0025B**

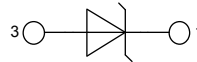

$V_{RRM} = 25\text{ V}$   
 $I_{FAV} = 25\text{ A}$   
 $V_F = 0.45\text{ V}$

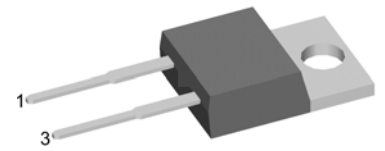

Backside: cathode

### Features / Advantages:

- Very low  $V_f$
- Extremely low switching losses
- low  $I_{rm}$  values
- Improved thermal behaviour
- High reliability circuit operation
- Low voltage peaks for reduced protection circuits
- Low noise switching

### Applications:

- Rectifiers in switch mode power supplies (SMPS)
- Free wheeling diode in low voltage converters

### Package:

- Housing: TO-220
- Industry standard outline
- Epoxy meets UL 94V-0
- RoHS compliant

Symbol	Definition	Conditions	Ratings			Unit	
			min.	typ.	max.		
$V_{RRM}$	max. repetitive reverse voltage	$T_{VJ} = 25^\circ\text{C}$			25	V	
$I_R$	reverse current	$V_R = 25\text{ V}$			20	mA	
		$V_R = 25\text{ V}$			80	mA	
$V_F$	forward voltage	$I_F = 25\text{ A}$			0.52	V	
		$I_F = 50\text{ A}$			0.67	V	
		$I_F = 25\text{ A}$	$T_{VJ} = 125^\circ\text{C}$			0.45	V
		$I_F = 50\text{ A}$	$T_{VJ} = 125^\circ\text{C}$			0.66	V
$I_{FAV}$	average forward current	rectangular, $d = 0.5$			25	A	
$V_{FD}$	threshold voltage	} for power loss calculation only			0.21	V	
$r_F$	slope resistance				8.8	$\text{m}\Omega$	
$R_{thJC}$	thermal resistance junction to case				1.40	K/W	
$T_{VJ}$	virtual junction temperature		-55		150	$^\circ\text{C}$	
$P_{tot}$	total power dissipation				90	W	
$I_{FSM}$	max. forward surge current	$t = 10\text{ ms}$ (50 Hz), sine			330	A	
$E_{AS}$	non-repetitive avalanche energy	$I_{AS} = 20\text{ A}$ ; $L = 100\ \mu\text{H}$			20	mJ	
$I_{AR}$	repetitive avalanche current	$V_A = 1.5 \cdot V_R$ typ.; $f = 10\text{ kHz}$			2	A	

Symbol	Definition	Conditions	Ratings			Unit
			min.	typ.	max.	
$I_{RMS}$	RMS current	per pin <sup>1)</sup>			35	A
$R_{thCH}$	thermal resistance case to heatsink			0.50		K/W
$T_{stg}$	storage temperature		-55		150	°C
<b>Weight</b>				2		g
$M_D$	mounting torque		0.4		0.8	Nm
$F_C$	mounting force with clip		20		60	N

<sup>1)</sup>  $I_{RMS}$  is typically limited by: 1. pin-to-chip resistance; or by 2. current capability of the chip.  
 In case of 1, a common cathode/anode configuration and a non-isolated backside, the whole current capability can be used by connecting the backside.

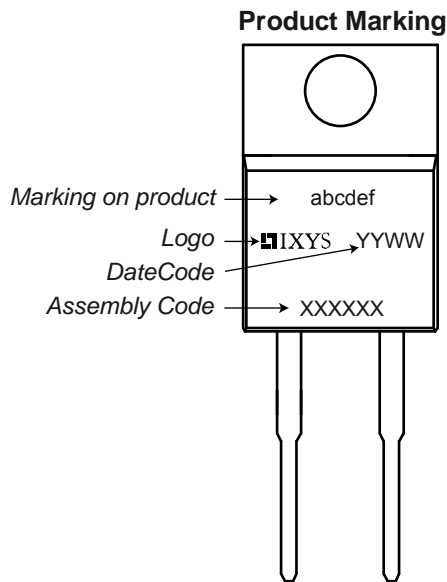

Ordering	Part Name	Marking on Product	Delivering Mode	Base Qty	Code Key
Standard	DSS25-0025B	DSS25-0025B	Tube	50	475114

Outlines TO-220

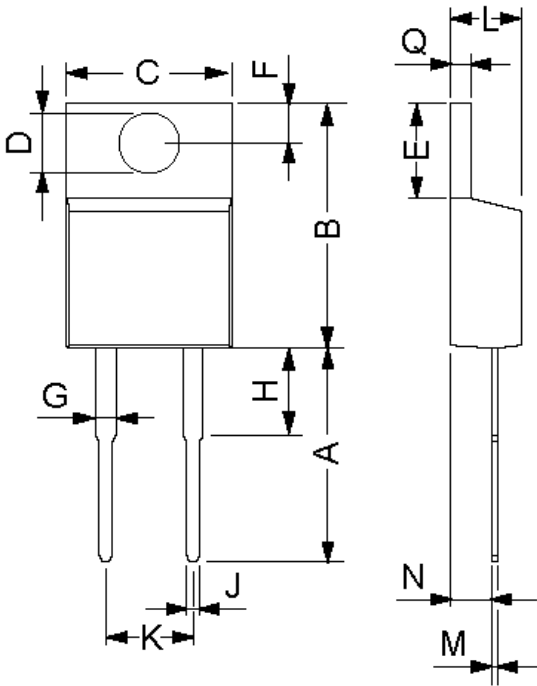

Dim.	Millimeter		Inches	
	Min.	Max.	Min.	Max.
A	12.7	14.73	0.5	0.58
B	14.23	16.51	0.56	0.65
C	9.66	10.66	0.38	0.42
D	3.54	4.08	0.139	0.161
E	5.85	6.85	2.3	0.42
F	2.54	3.42	0.1	0.135
G	1.15	1.77	0.045	0.07
H	-	6.35	-	0.25
J	0.64	0.89	0.025	0.035
K	4.83	5.33	0.19	0.21
L	3.56	4.82	0.14	0.19
M	0.51	0.76	0.02	0.03
N	2.04	2.49	0.08	0.115
Q	0.64	1.39	0.025	0.055

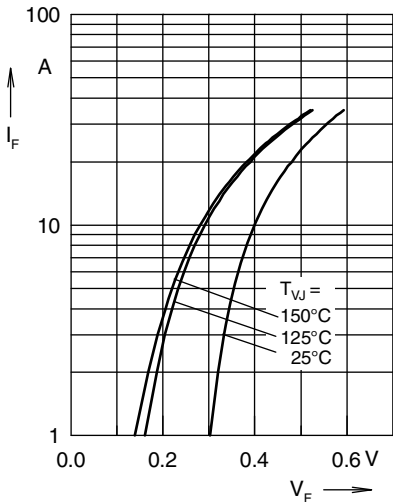

Fig. 1 Maximum forward voltage drop characteristics

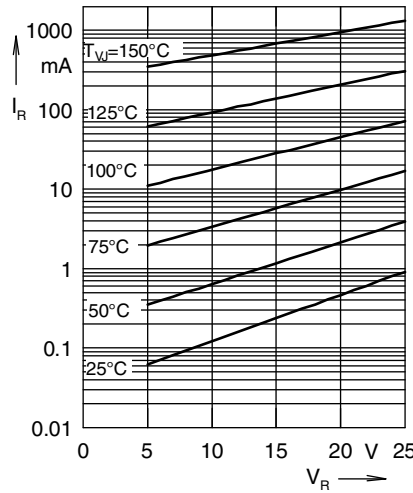

Fig. 2 Typ. value of reverse current  $I_R$  vs. reverse voltage  $V_R$

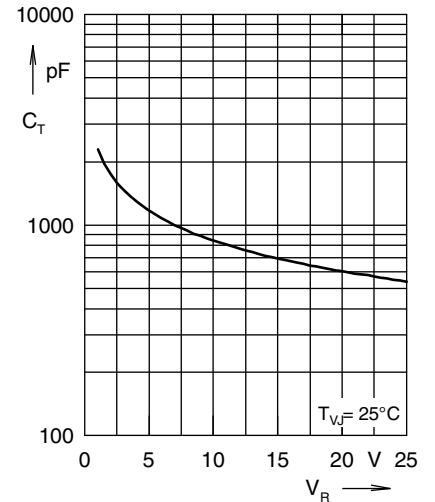

Fig. 3 Typ. junction capacitance  $C_T$  vs. reverse voltage  $V_R$

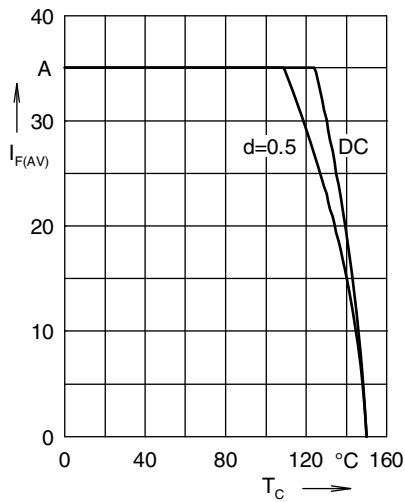

Fig. 4 Avg. forward current  $I_{F(AV)}$  vs. case temperature  $T_C$

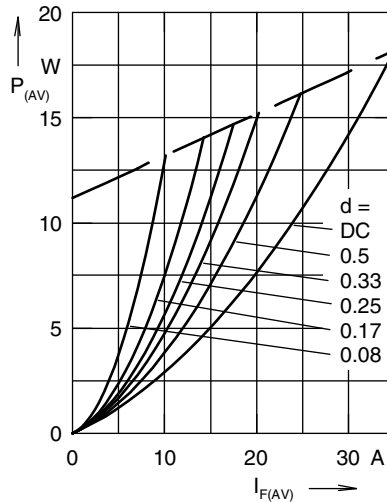

Fig. 5 Forward power loss characteristics

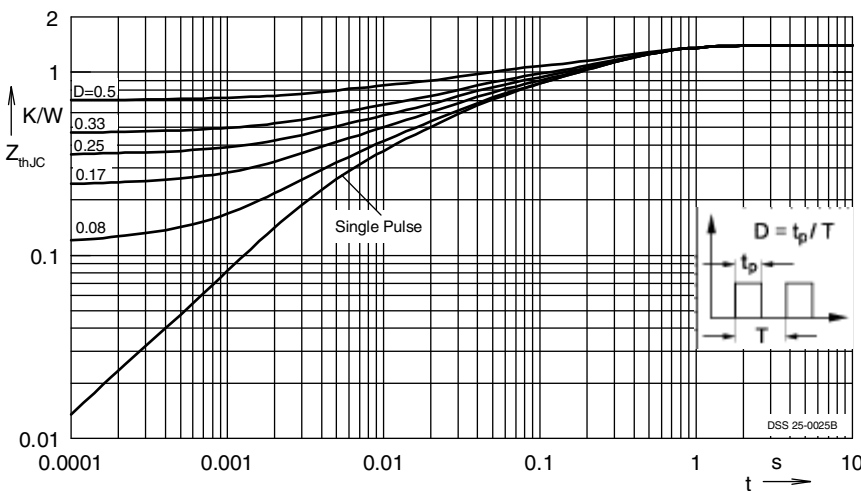

Fig. 6 Transient thermal impedance junction to case at various duty cycles

Note: All curves are per diode