

# Three phase full Bridge

with Trench MOSFETs  
in DCB isolated high current package

$V_{DSS} = 100\text{ V}$   
 $I_{D25} = 90\text{ A}$   
 $R_{DSon\ typ.} = 7.5\text{ m}\Omega$

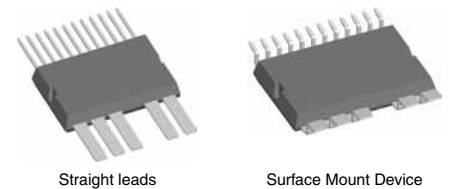
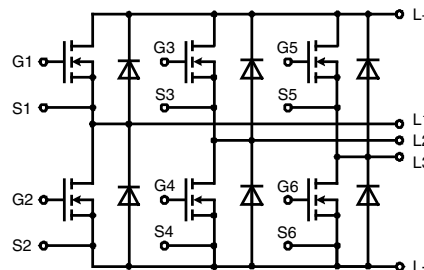

MOSFETs		Maximum Ratings	
Symbol	Conditions		
$V_{DSS}$	$T_J = 25^\circ\text{C to } 150^\circ\text{C}$	100	V
$V_{GS}$		$\pm 20$	V
$I_{D25}$	$T_C = 25^\circ\text{C}$	90	A
$I_{D90}$	$T_C = 90^\circ\text{C}$	68	A
$I_{F25}$	$T_C = 25^\circ\text{C (diode)}$	90	A
$I_{F90}$	$T_C = 90^\circ\text{C (diode)}$	68	A

### Applications

- AC drives
- in automobiles
    - electric power steering
    - starter generator
  - in industrial vehicles
    - propulsion drives
    - fork lift drives
  - in battery supplied equipment

### Features

- MOSFETs in trench technology:
  - low  $R_{DSon}$
  - optimized intrinsic reverse diode
- package:
  - high level of integration
  - high current capability 300 A max.
  - aux. terminals for MOSFET control
  - terminals for soldering or welding connections
  - isolated DCB ceramic base plate with optimized heat transfer
- Space and weight savings

Symbol	Conditions	Characteristic Values				
		min.	typ.	max.		
$(T_J = 25^\circ\text{C, unless otherwise specified})$						
$R_{DSon}^{1)}$	on chip level at $V_{GS} = 10\text{ V}; I_D = 80\text{ A}$	$T_J = 25^\circ\text{C}$ $T_J = 125^\circ\text{C}$		7.5 14	8.5 m $\Omega$	
$V_{GS(th)}$	$V_{DS} = 20\text{ V}; I_D = 250\ \mu\text{A}$		2.5		4.5 V	
$I_{DSS}$	$V_{DS} = V_{DSS}; V_{GS} = 0\text{ V}$	$T_J = 25^\circ\text{C}$ $T_J = 125^\circ\text{C}$		0.1	1 $\mu\text{A}$ mA	
$I_{GSS}$	$V_{GS} = \pm 20\text{ V}; V_{DS} = 0\text{ V}$				0.2 $\mu\text{A}$	
$Q_g$ $Q_{gs}$ $Q_{gd}$	$V_{GS} = 10\text{ V}; V_{DS} = 65\text{ V}; I_D = 90\text{ A}$			90 30 30	nC nC nC	
$t_{d(on)}$ $t_r$ $t_{d(off)}$ $t_f$		inductive load $V_{GS} = 10\text{ V}; V_{DS} = 48\text{ V}$ $I_D = 70\text{ A}; R_G = 33\ \Omega;$ $T_J = 125^\circ\text{C}$			130 95 290 55	ns ns ns ns
$E_{on}$ $E_{off}$ $E_{recoff}$					0.4 0.4 0.007	mJ mJ mJ
$R_{thJC}$ $R_{thJH}$	with heat transfer paste (IXYS test setup)				1.3 1.6	K/W K/W

<sup>1)</sup>  $V_{DS} = I_D \cdot (R_{DS(on)} + 2R_{Pin\ to\ chip})$

### Package options

- 2 lead frames available
  - straight leads (SL)
  - SMD lead version (SMD)

**Source-Drain Diode**

Symbol	Conditions	Characteristic Values			
		min.	typ.	max.	
(T <sub>J</sub> = 25°C, unless otherwise specified)					
V <sub>SD</sub>	(diode) I <sub>F</sub> = 70 A; V <sub>GS</sub> = 0 V		0.9	1.2	V
t <sub>rr</sub>	I <sub>F</sub> = 70 A; -di <sub>F</sub> /dt = 800 A/μs; V <sub>R</sub> = 48 V		55		ns
Q <sub>RM</sub>			0.95		μC
I <sub>RM</sub>			33		A

**Component**

Symbol	Conditions	Maximum Ratings	
I <sub>RMS</sub>	per pin in main current paths (P+, N-, L1, L2, L3) may be additionally limited by external connections	300	A
T <sub>J</sub>		-55...+175	°C
T <sub>stg</sub>		-55...+125	°C
V <sub>ISOL</sub>	I <sub>ISOL</sub> ≤ 1 mA, 50/60 Hz, f = 1 minute	1000	V~
F <sub>c</sub>	mounting force with clip	50 - 250	N

Symbol	Conditions	Characteristic Values		
		min.	typ.	max.
R <sub>pin to chip</sub> <sup>1)</sup>			0.6	mΩ
C <sub>p</sub>	coupling capacity between shorted pins and mounting tab in the case		160	pF
Weight			25	g

<sup>1)</sup> V<sub>DS</sub> = I<sub>D</sub> · (R<sub>DS(on)</sub> + 2R<sub>Pin to Chip</sub>)

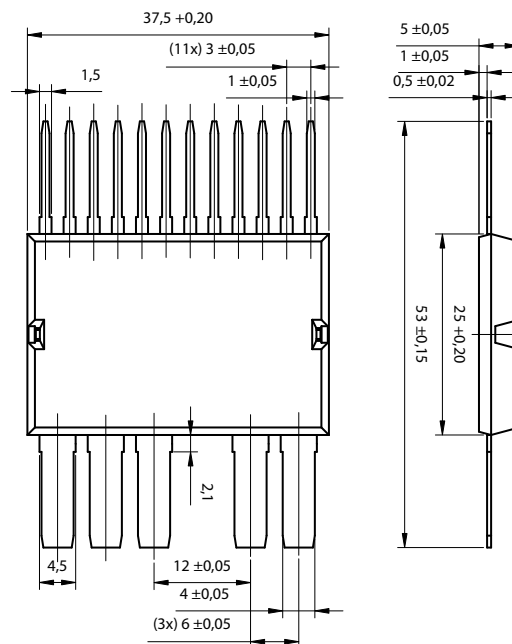
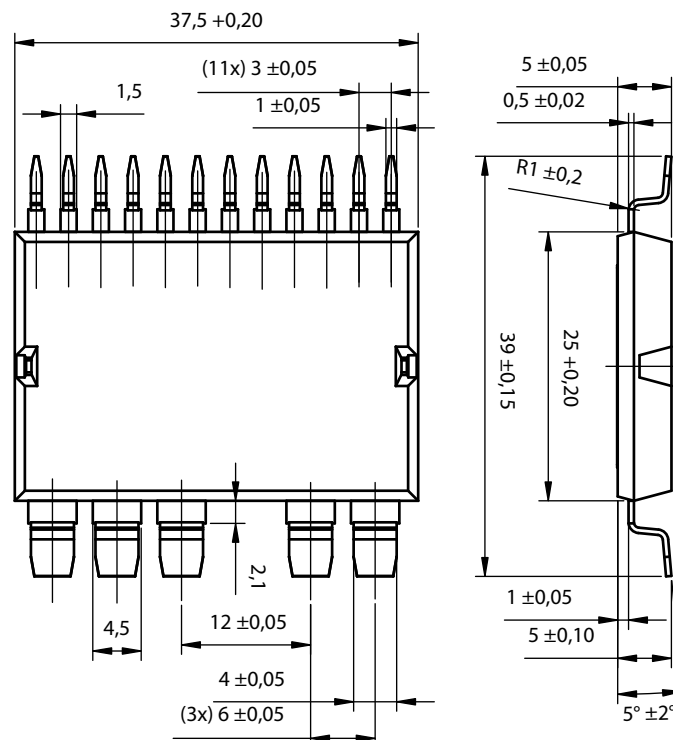
**Straight Leads GWM 100-01X1-SL**

**Surface Mount Device GWM 100-01X1-SMD**

Leads	Ordering	Part Name & Packing Unit Marking	Part Marking	Delivering Mode	Base Qty.	Ordering Code
Straight	Standard	GWM 100-01X1 - SL	GWM 100-01X1	Blister	28	505 535
SMD	Standard	GWM 100-01X1 - SMD	GWM 100-01X1	Blister	28	505 542

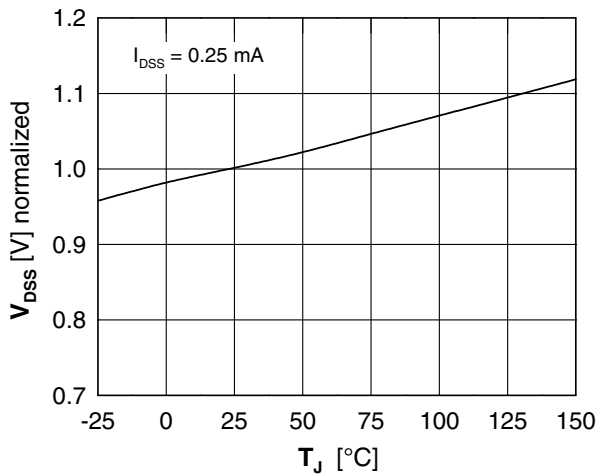

Fig. 1 Drain source breakdown voltage  $V_{DSS}$  vs. junction temperature  $T_J$

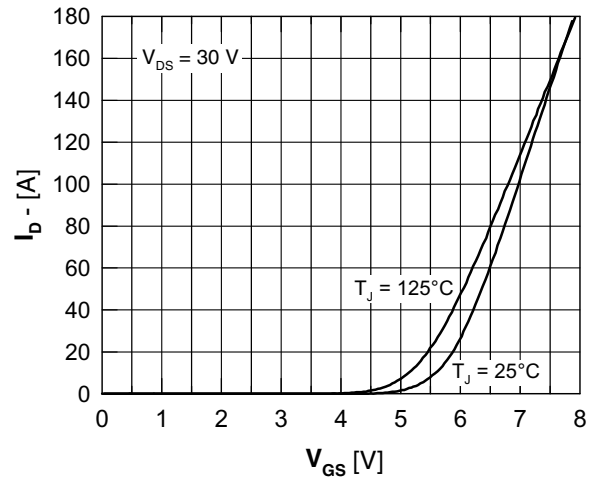

Fig. 2 Typical transfer characteristic

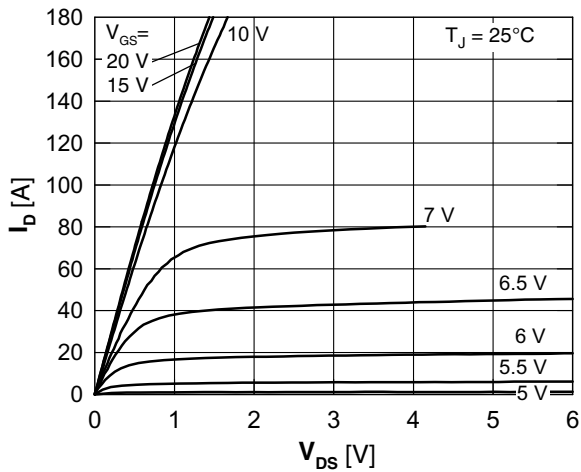

Fig. 3 Typical output characteristic

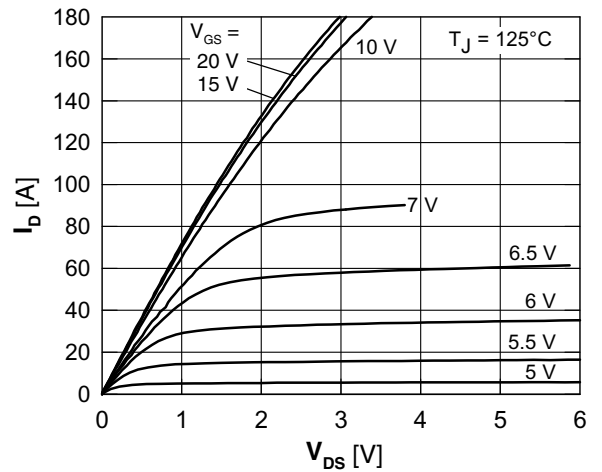

Fig. 4 Typical output characteristic

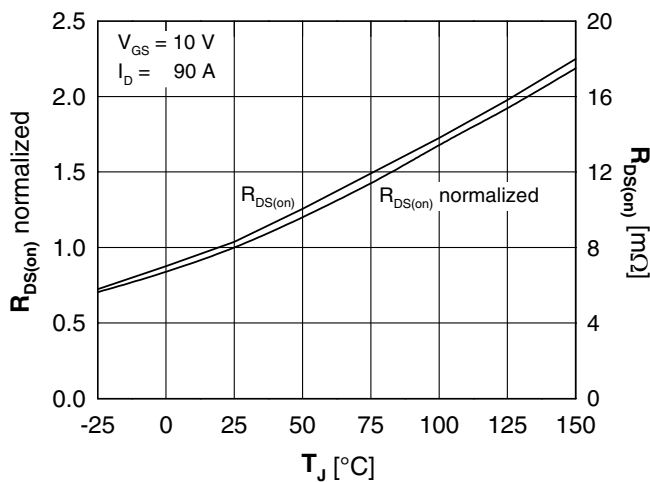

Fig. 5 Drain source on-state resistance  $R_{DS(on)}$  versus junction temperature  $T_J$

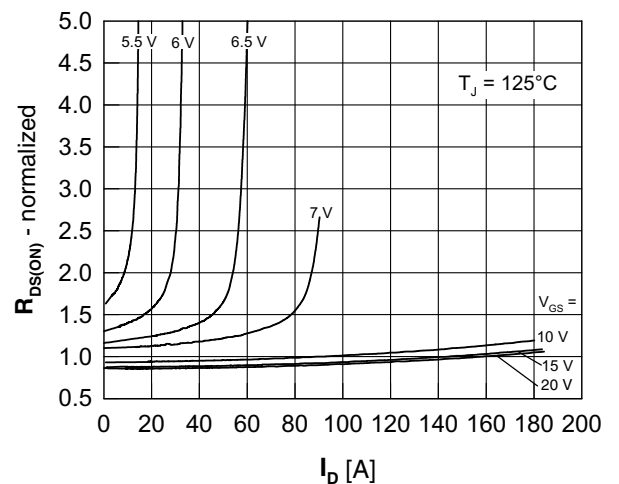

Fig. 6 Drain source on-state resistance  $R_{DS(on)}$  versus  $I_D$

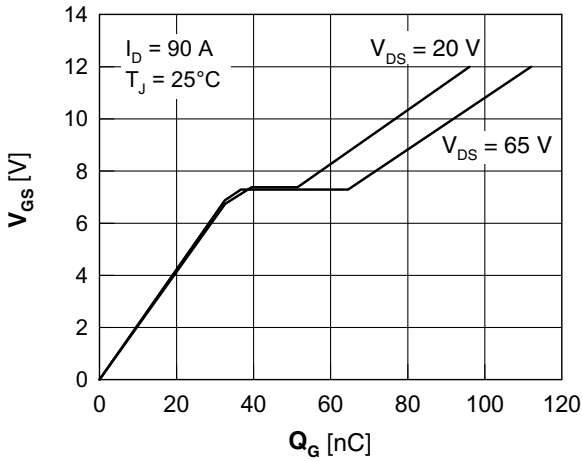

Fig.7 Gate charge characteristic

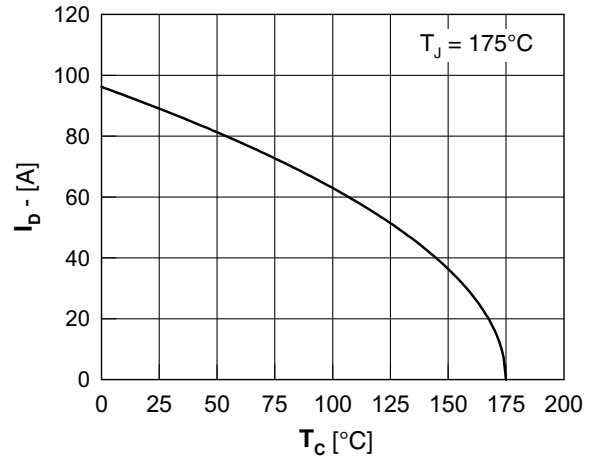

Fig. 8 Drain current  $I_D$  vs. case temperature  $T_c$

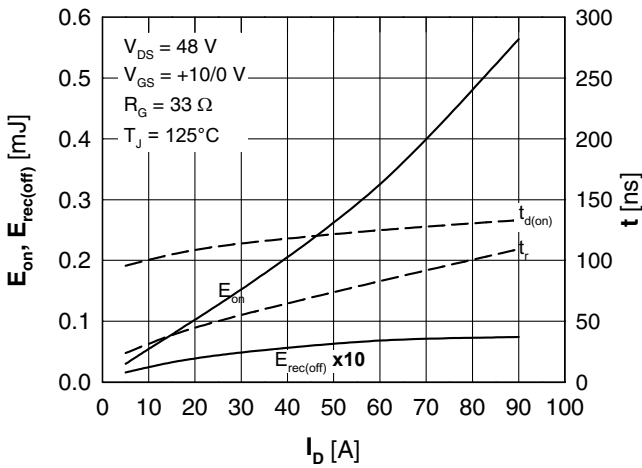

Fig. 9 Typ. turn-on energy & switching times vs. collector current, inductive switching

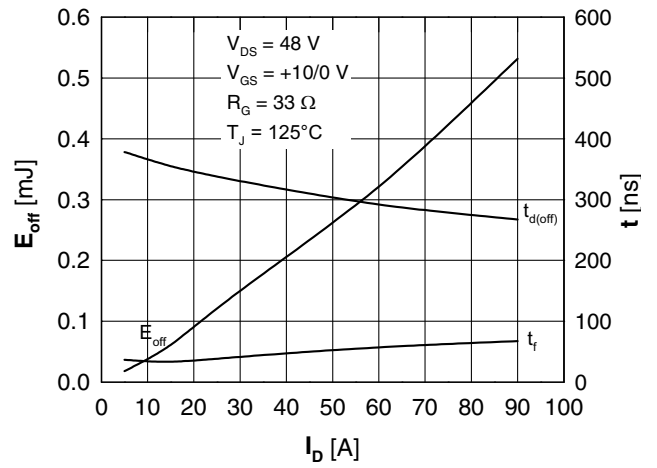

Fig. 10 Typ. turn-off energy & switching times vs. collector current, inductive switching

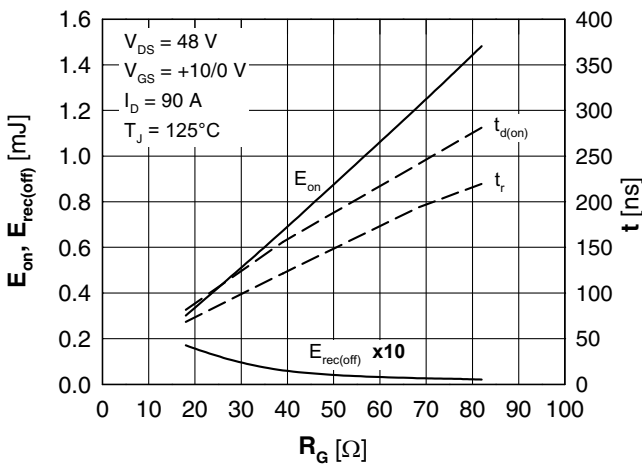

Fig. 11 Typ. turn-on energy & switching times vs. gate resistor, inductive switching

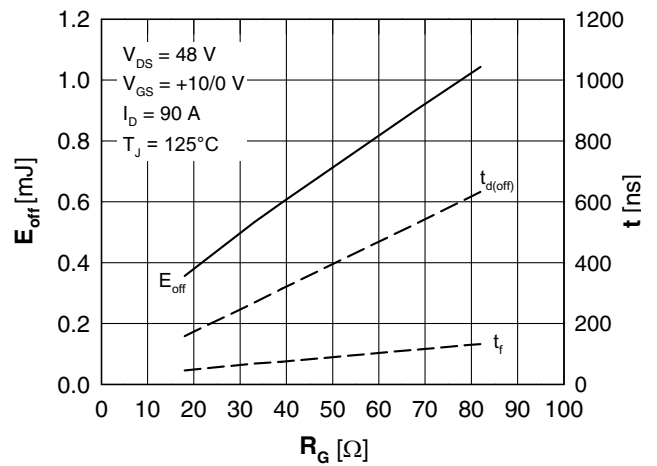

Fig. 12 Typ. turn-off energy & switching times vs. gate resistor, inductive switching

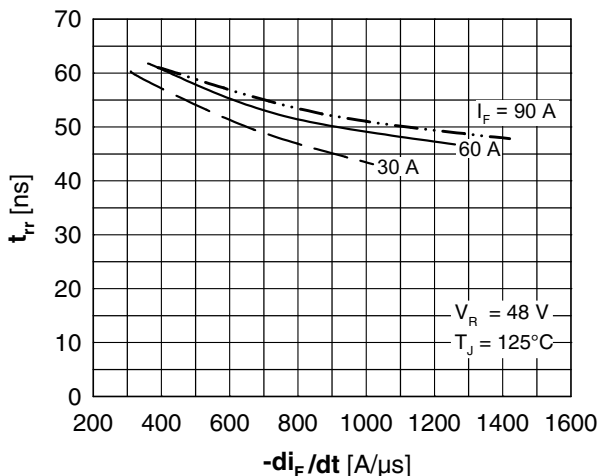

Fig. 13 Reverse recovery time  $t_{rr}$  of the body diode vs.  $di/dt$

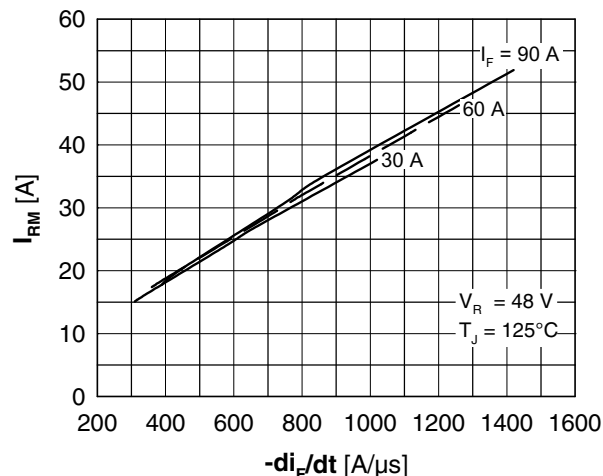

Fig. 14 Reverse recovery current  $I_{RM}$  of the body diode vs.  $di/dt$

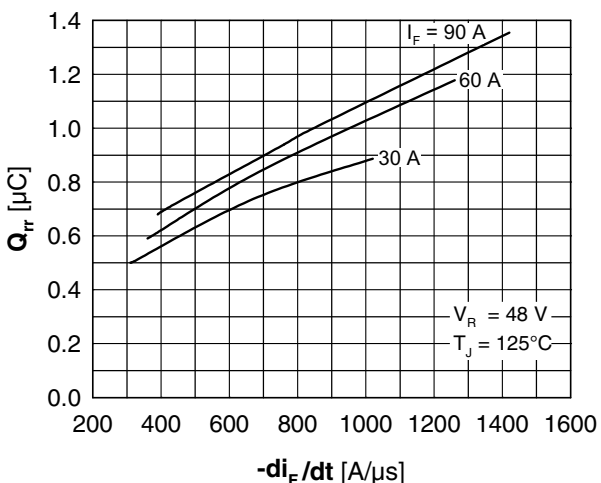

Fig. 15 Reverse recovery charge  $Q_{rr}$  of the body diode vs.  $di/dt$

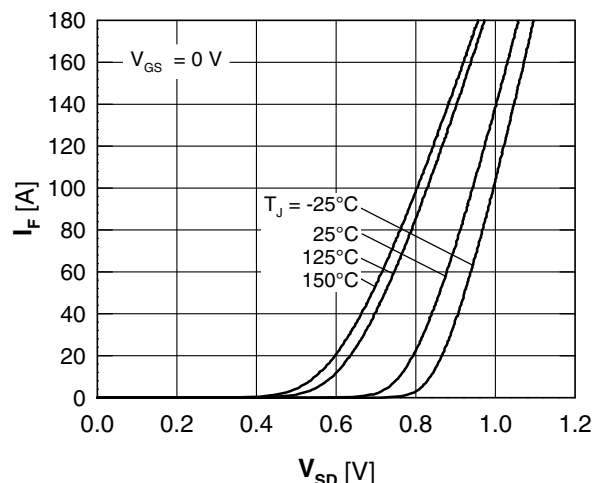

Fig. 16 Source drain diode current  $I_F$  vs. source drain voltage  $V_{SD}$  (body diode)

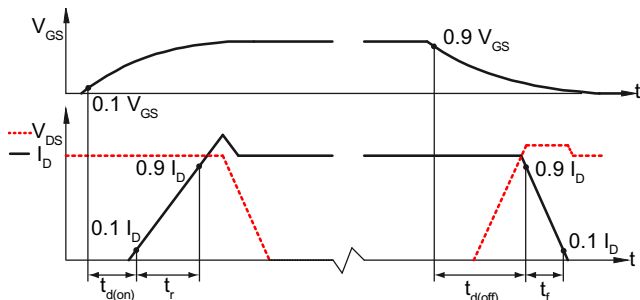

Fig. 17 Definition of switching times

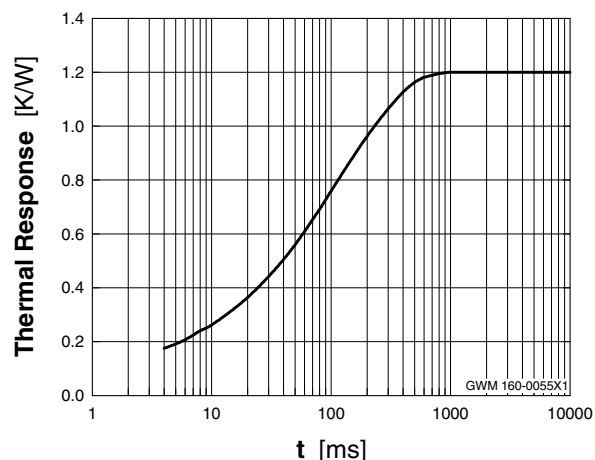

Fig. 18 Typ. thermal impedance junction to heatsink  $Z_{thJH}$  with heat transfer paste