

Three phase full Bridge

with Trench MOSFETs
in DCB isolated high current package

$V_{DSS} = 40\text{ V}$
 $I_{D25} = 180\text{ A}$
 $R_{DSon\ typ.} = 1.9\text{ m}\Omega$

Preliminary data

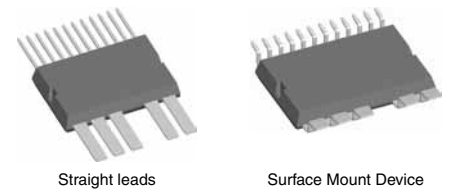
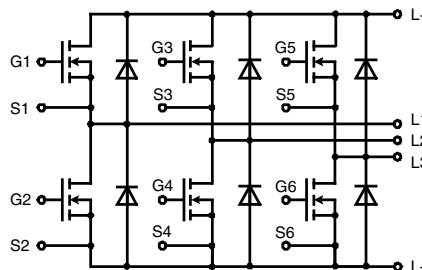

MOSFETs		Maximum Ratings	
Symbol	Conditions		
V_{DSS}	$T_J = 25^\circ\text{C to } 150^\circ\text{C}$	40	V
V_{GS}		± 20	V
I_{D25}	$T_C = 25^\circ\text{C}$	180	A
I_{D90}	$T_C = 90^\circ\text{C}$	136	A
I_{D110}	$T_C = 110^\circ\text{C}$	120	A
I_{F25}	$T_C = 25^\circ\text{C}$ (diode)	182	A
I_{F90}	$T_C = 90^\circ\text{C}$ (diode)	112	A
I_{F110}	$T_C = 110^\circ\text{C}$ (diode)	88	A

Applications

AC drives

- in automobiles
 - electric power steering
 - starter generator
- in industrial vehicles
 - propulsion drives
 - fork lift drives
- in battery supplied equipment

Features

- MOSFETs in trench technology:
 - low R_{DSon}
 - optimized intrinsic reverse diode
- package:
 - high level of integration
 - high current capability 300 A max.
 - aux. terminals for MOSFET control
 - terminals for soldering or welding connections
 - isolated DCB ceramic base plate with optimized heat transfer
- Space and weight savings

Symbol	Conditions	Characteristic Values			
		$(T_J = 25^\circ\text{C}, \text{ unless otherwise specified})$			
		min.	typ.	max.	
$R_{DSon}^{1)}$	on chip level at $V_{GS} = 10\text{ V}; I_D = 100\text{ A}$		1.9	2.5	$\text{m}\Omega$
			2.8		$\text{m}\Omega$
$V_{GS(th)}$	$V_{DS} = 20\text{ V}; I_D = 1\text{ mA}$	2.5		4.5	V
I_{DSS}	$V_{DS} = V_{DSS}; V_{GS} = 0\text{ V}$			5	μA
			50		μA
I_{GSS}	$V_{GS} = \pm 20\text{ V}; V_{DS} = 0\text{ V}$			0.2	μA
Q_g	$V_{GS} = 10\text{ V}; V_{DS} = 20\text{ V}; I_D = 100\text{ A}$		110		nC
Q_{gs}			33		nC
Q_{gd}			30		nC
$t_{d(on)}$	inductive load $V_{GS} = +10/0\text{ V}; V_{DS} = 24\text{ V}$ $I_D = 135\text{ A}; R_G = 39\ \Omega;$ $T_J = 125^\circ\text{C}$		150		ns
t_r			240		ns
$t_{d(off)}$			350		ns
t_f			170		ns
E_{on}			0.12		mJ
E_{off}		0.51		mJ	
E_{recoff}		0.003		mJ	
R_{thJC}	with heat transfer paste (IXYS test setup)			1.0	K/W
R_{thJH}			1.3	1.6	K/W

¹⁾ $V_{DS} = I_D \cdot (R_{DS(on)} + R_{Pin\ to\ Chip})$

Source-Drain Diode

Symbol	Conditions	Characteristic Values			
		min.	typ.	max.	
($T_J = 25^\circ\text{C}$, unless otherwise specified)					
V_{SD}	(diode) $I_F = 100\text{ A}$; $V_{GS} = 0\text{ V}$		0.9	1.2	V
t_{rr}	$I_F = 100\text{ A}$; $-di_F/dt = 600\text{ A}/\mu\text{s}$ $V_R = 15\text{ V}$; $T_{VJ} = 125^\circ\text{C}$		38		ns
Q_{RM}			0.31		μC
I_{RM}			14		A

Component

Symbol	Conditions	Maximum Ratings	
I_{RMS}	per pin in main current paths (P+, N-, L1, L2, L3) may be additionally limited by external connections	300	A
T_J		-55...+175	$^\circ\text{C}$
T_{stg}		-55...+125	$^\circ\text{C}$
V_{ISOL}	$I_{ISOL} \leq 1\text{ mA}$, 50/60 Hz, $f = 1\text{ minute}$	1000	V~
F_c	mounting force with clip	50 - 250	N

Symbol	Conditions	Characteristic Values		
		min.	typ.	max.
$R_{pin\ to\ chip}^{1)}$	L+ to L1/L2/L3 or L- to L1/L2/L3		1.0	$\text{m}\Omega$
C_p	coupling capacity between shorted pins and mounting tab in the case		160	pF
Weight			25	g

¹⁾ $V_{DS} = I_D \cdot (R_{DS(on)} + R_{Pin\ to\ Chip})$

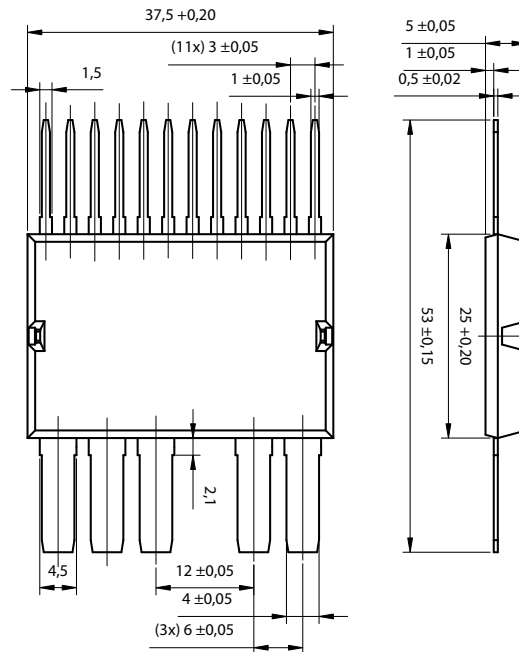
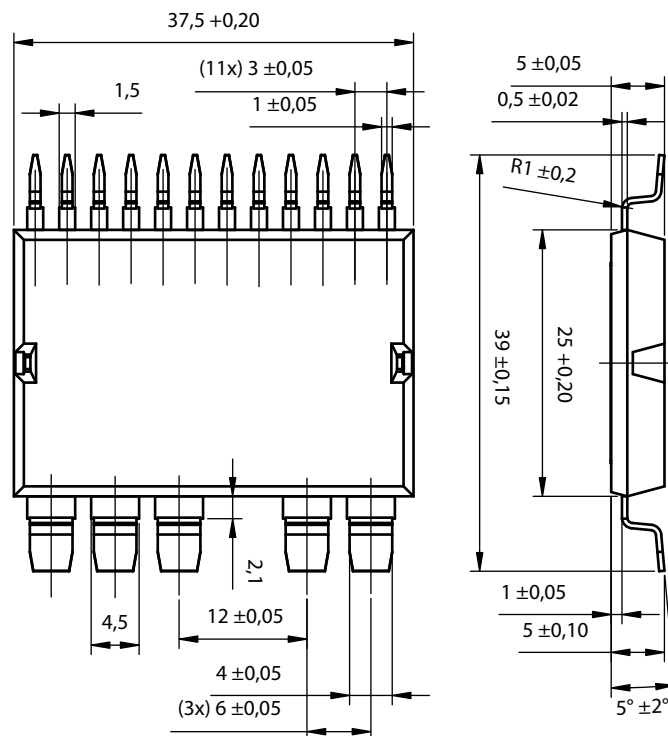
Straight Leads GWM 180-004X2-SL

Surface Mount Device GWM 180-004X2-SMD

Leads	Ordering	Part Name & Packing Unit Marking	Part Marking	Delivering Mode	Base Qty.	Ordering Code
Straight	Standard	GWM 180-004X2 - SL	GWM 180-004X2	Blister	28	508 772
SMD	Standard	GWM 180-004X2 - SMD	GWM 180-004X2	Blister	28	508 786

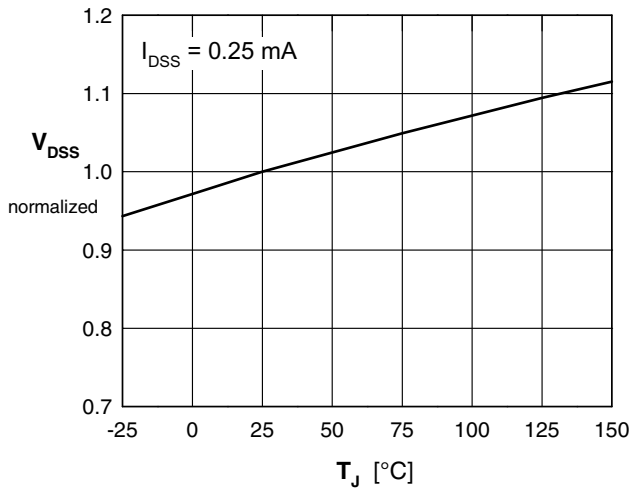

Fig. 1 Drain source breakdown voltage V_{DSS} versus junction temperature T_{VJ}

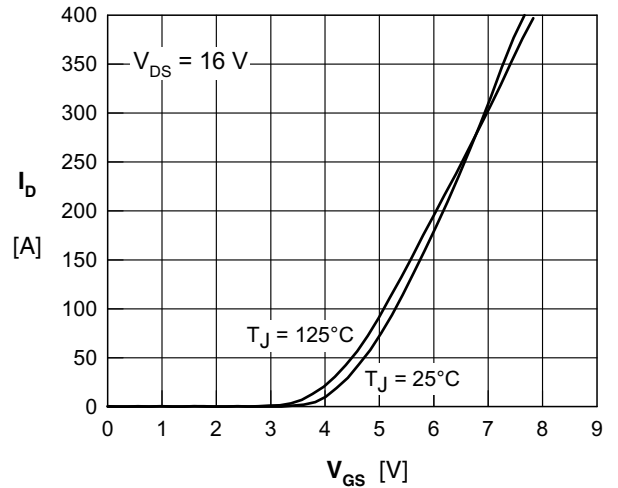

Fig. 2 Typical transfer characteristic

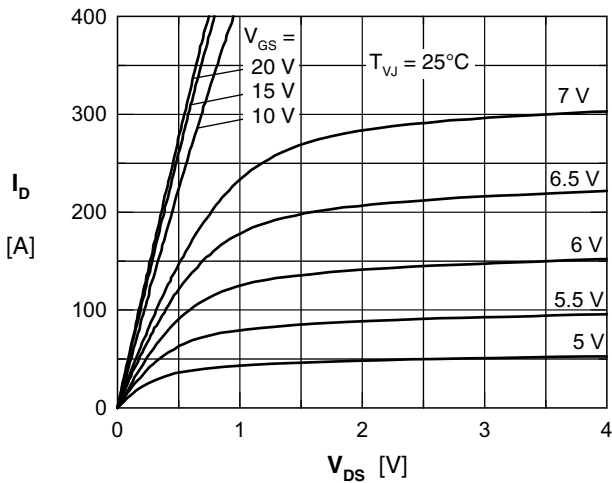

Fig. 3 Typical output characteristic

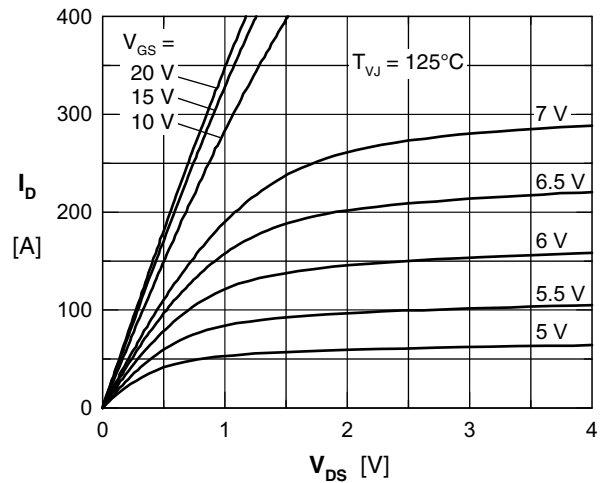

Fig. 4 Typical output characteristic

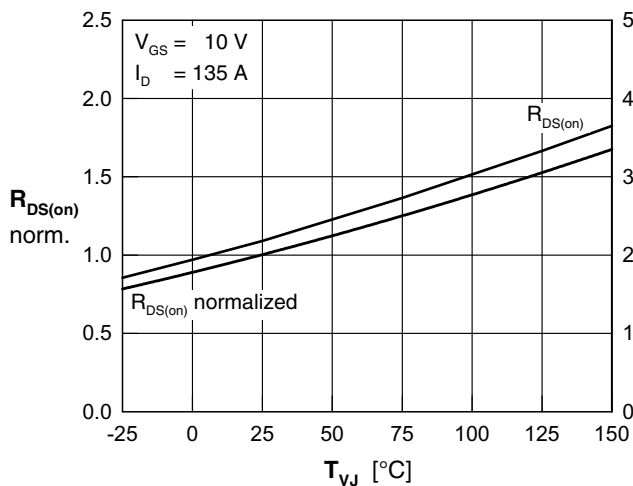

Fig. 5 Typ. drain source on-state resistance $R_{DS(on)}$ versus junction temperature T_J

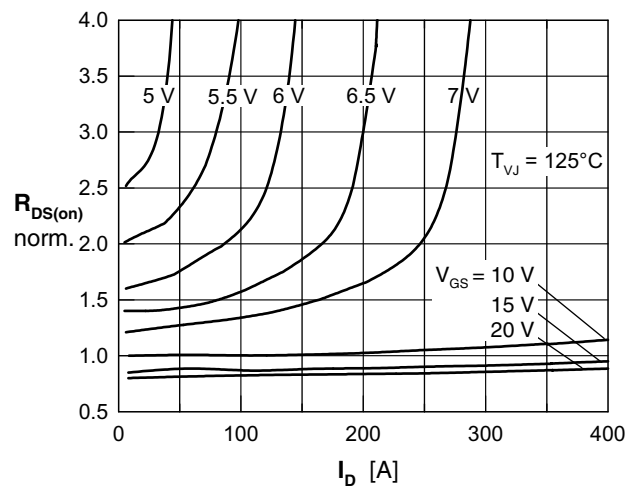

Fig. 6 Typ. drain source on-state resistance $R_{DS(on)}$ versus I_D

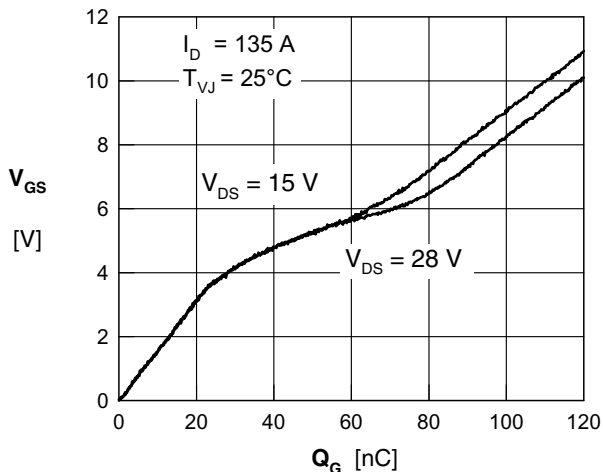

Fig. 7 Gate charge characteristics

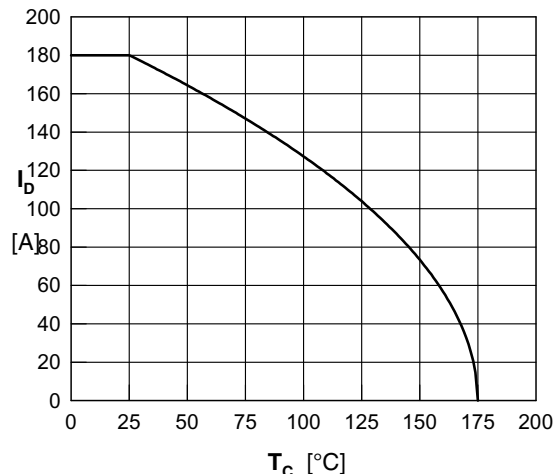
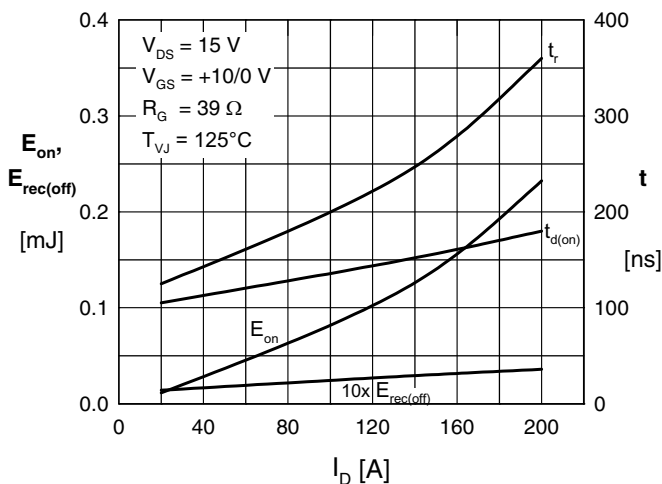

 Fig. 8 Drain current I_D vs. temperature T_C

Fig. 9 Typ. turn-on energy & switching times vs. collector current, inductive switching

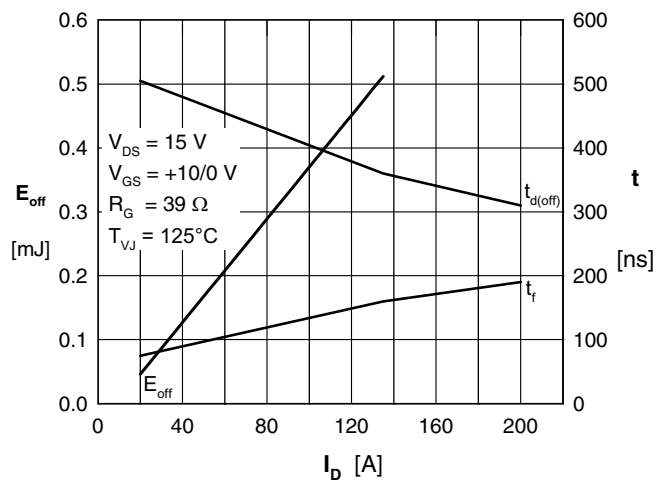

Fig. 10 Typ. turn-off energy & switching times vs. collector current, inductive switching

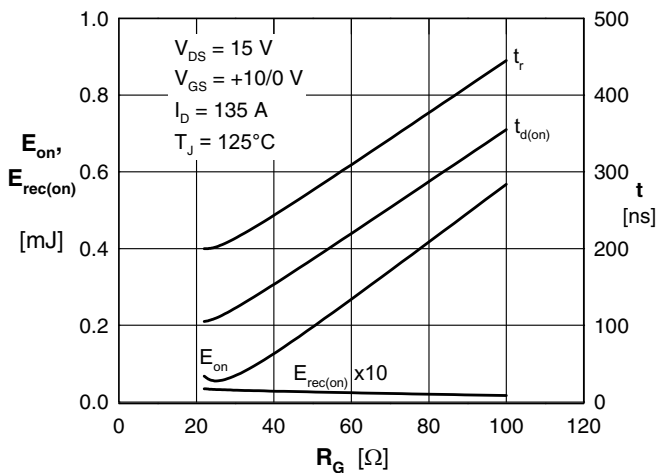

Fig. 11 Typ. turn-on energy & switching times vs. gate resistor, inductive switching

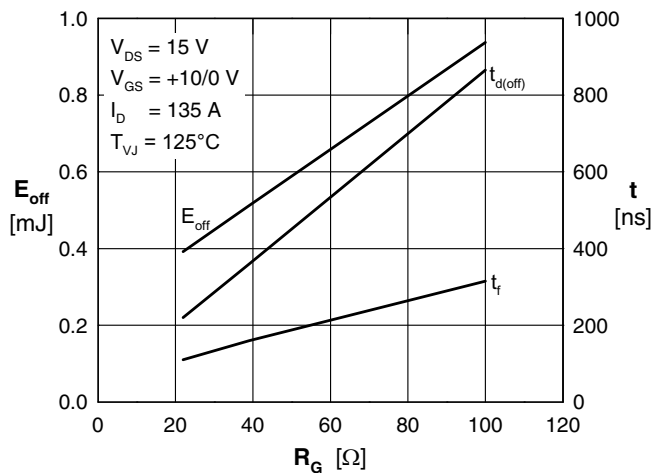

Fig. 12 Typ. turn-off energy & switching times vs. gate resistor, inductive switching

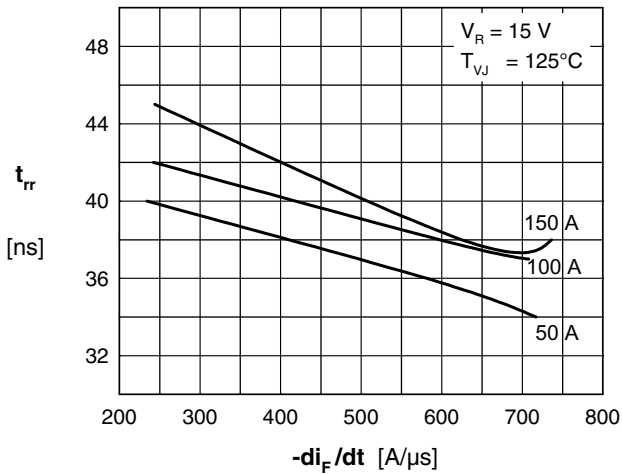

Fig. 13 Reverse recovery time t_{rr} of the body diodes vs. di/dt

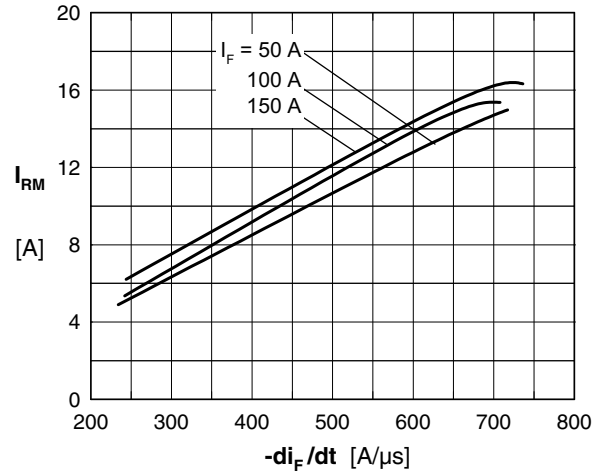

Fig. 14 Reverse recovery current I_{RM} of the body diodes versus di/dt

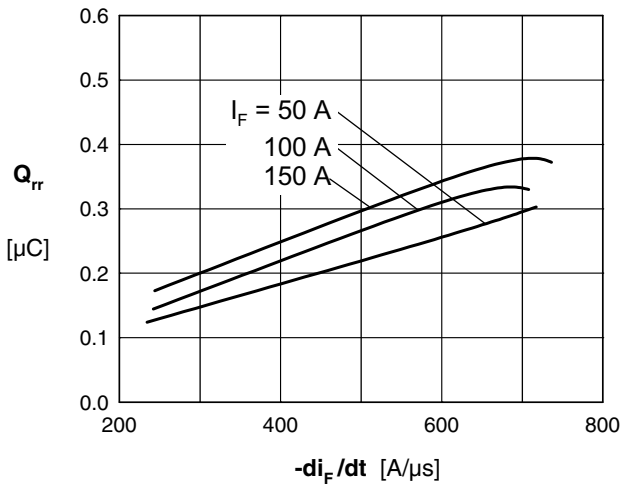

Fig. 15 Reverse recovery charge Q_{rr} of the body diodes versus di/dt

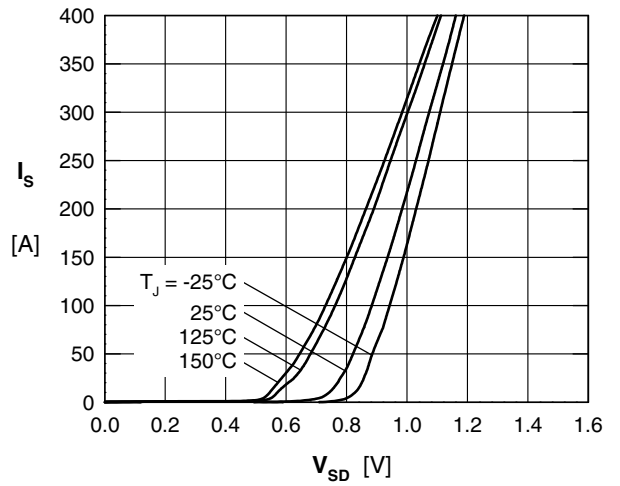

Fig. 16 Source current I_s versus source drain voltage V_{SD} (body diode)

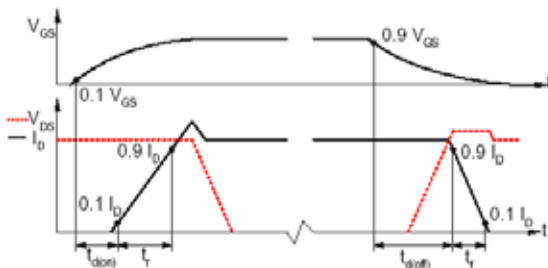

Fig. 17 Definition of switching times