

High Voltage, High Gain BIMOSFET™ Monolithic Bipolar MOS Transistor

IXBH 10N170
IXBT 10N170

$V_{CES} = 1700 \text{ V}$
 $I_{C25} = 20 \text{ A}$
 $V_{CE(sat)} = 3.8 \text{ V}$

Preliminary Data Sheet

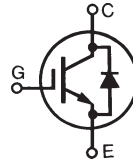

Symbol	Test Conditions	Maximum Ratings
V_{CES}	$T_J = 25^\circ\text{C}$ to 150°C	1700 V
V_{CGR}	$T_J = 25^\circ\text{C}$ to 150°C ; $R_{GE} = 1 \text{ M}\Omega$	1700 V
V_{GES}	Continuous	± 20 V
V_{GEM}	Transient	± 30 V
I_{C25}	$T_C = 25^\circ\text{C}$	20 A
I_{C90}	$T_C = 90^\circ\text{C}$	10 A
I_{CM}	$T_C = 25^\circ\text{C}$, 1 ms	40 A
SSOA (RBSOA)	$V_{GE} = 15 \text{ V}$, $T_{VJ} = 125^\circ\text{C}$, $R_G = 33 \Omega$ Clamped inductive load	$I_{CM} = 20$ A $V_{CES} = 1350$ V
P_C	$T_C = 25^\circ\text{C}$	140 W
T_J		-55 ... +150 $^\circ\text{C}$
T_{JM}		150 $^\circ\text{C}$
T_{stg}		-55 ... +150 $^\circ\text{C}$
	Maximum Lead temperature for soldering 1.6 mm (0.062 in.) from case for 10 s	300 $^\circ\text{C}$
	Maximum Tab temperature for soldering SMD devices for 10 s	260 $^\circ\text{C}$
M_d	Mounting torque (M3) (TO-247)	1.13/10Nm/lb.in.
Weight	TO-247 AD	6 g
	TO-268	4 g

TO-268 (IXBT)

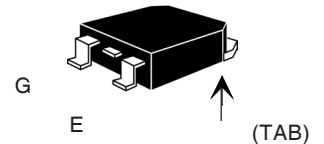

TO-247 AD (IXBH)

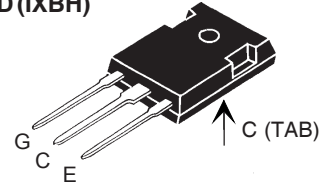

G = Gate, C = Collector,
E = Emitter, TAB = Collector

Features

- High Blocking Voltage
- JEDEC TO-268 surface and JEDEC TO-247 AD
- Low conduction losses
- High current handling capability
- MOS Gate turn-on - drive simplicity
- Molding epoxies meet UL 94 V-0 flammability classification

Applications

- AC motor speed control
- Uninterruptible power supplies (UPS)
- Switched-mode and resonant-mode power supplies
- Capacitor discharge circuits

Advantages

- High power density
- Suitable for surface mounting
- Easy to mount with 1 screw, (isolated mounting screw hole)

Symbol	Test Conditions	Characteristic Values ($T_J = 25^\circ\text{C}$, unless otherwise specified)		
		min.	typ.	max.
BV_{CES}	$I_C = 250 \mu\text{A}$, $V_{GE} = 0 \text{ V}$ Temperature Coefficient	1700	0.10	V %/K
$V_{GE(th)}$	$I_C = 250 \mu\text{A}$, $V_{CE} = V_{GE}$ Temperature Coefficient	3.0	- 0.24	5.0 V %/K
I_{CES}	$V_{CE} = 0.8 V_{CES}$, $T_J = 25^\circ\text{C}$ $V_{GE} = 0 \text{ V}$, $T_J = 125^\circ\text{C}$			10 μA 100 μA
I_{GES}	$V_{CE} = 0 \text{ V}$, $V_{GE} = \pm 20 \text{ V}$			± 100 nA
$V_{CE(sat)}$	$I_C = I_{C90}$, $V_{GE} = 15 \text{ V}$ $T_J = 125^\circ\text{C}$	3.4	4.1	3.8 V V

Symbol	Test Conditions	Characteristic Values		
		$(T_J = 25^\circ\text{C}, \text{ unless otherwise specified})$		
		min.	typ.	max.
g_{fs}	$I_C = I_{C90}, V_{CE} = 10\text{ V}$, Pulse test, $t \leq 300\ \mu\text{s}$, duty cycle $\leq 2\%$	4.0	6.5	S
C_{ies}	$V_{CE} = 25\text{ V}, V_{GE} = 0\text{ V}, f = 1\text{ MHz}$		700	pF
C_{oes}			40	pF
C_{res}			12	pF
Q_g	$I_C = I_{C90}, V_{GE} = 15\text{ V}, V_{CE} = 0.5 V_{CES}$		30	nC
Q_{ge}			6	nC
Q_{gc}			10	nC
$t_{d(on)}$	Inductive load, $T_J = 25^\circ\text{C}$ $I_C = I_{C90}, V_{GE} = 15\text{ V}$ $V_{CE} = 0.8 V_{CES}, R_G = R_{off} = 56\ \Omega$		35	ns
t_{ri}			28	ns
$t_{d(off)}$			500	ns
t_{fi}			1000	ns
E_{off}			6	mJ
$t_{d(on)}$	Inductive load, $T_J = 125^\circ\text{C}$ $I_C = I_{C90}, V_{GE} = 15\text{ V}$ $V_{CE} = 0.8 V_{CES}, R_G = R_{off} = 56\ \Omega$		35	ns
t_{ri}			28	ns
E_{on}			0.7	mJ
$t_{d(off)}$			600	ns
t_{fi}			1200	ns
E_{off}		8	mJ	
R_{thJC}				0.89 K/W
R_{thCK}	(TO-247)	0.25		K/W

Symbol	Test Conditions	Characteristic Values		
		$(T_J = 25^\circ\text{C}, \text{ unless otherwise specified})$		
		min.	typ.	max.
V_F	$I_F = I_{C90}, V_{GE} = 0\text{ V}$, Pulse test, $t \leq 300\ \mu\text{s}$, duty cycle $d \leq 2\%$			3.0 V
I_{RM}	$I_F = I_{C90}, V_{GE} = 0\text{ V}, -di_F/dt = 50\text{ A}/\mu\text{s}$		10	A
t_{rr}		$V_R = 100\text{ V}$		360

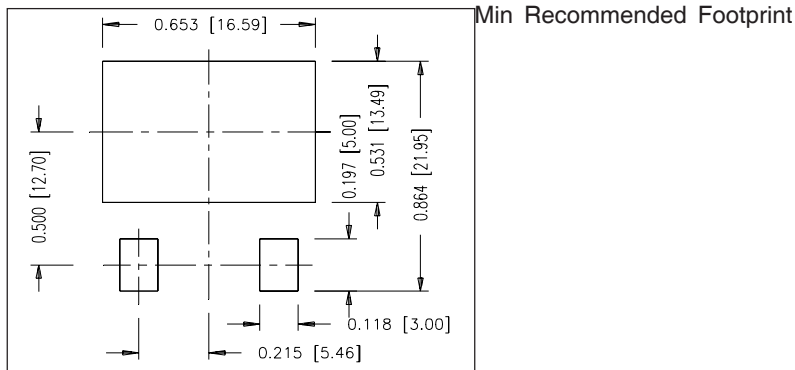

TO-247 AD Outline

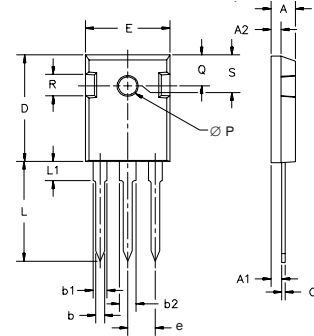

Dim.	Millimeter		Inches	
	Min.	Max.	Min.	Max.
A	4.7	5.3	.185	.209
A ₁	2.2	2.54	.087	.102
A ₂	2.2	2.6	.059	.098
b	1.0	1.4	.040	.055
b ₁	1.65	2.13	.065	.084
b ₂	2.87	3.12	.113	.123
C	.4	.8	.016	.031
D	20.80	21.46	.819	.845
E	15.75	16.26	.610	.640
e	5.20	5.72	0.205	0.225
L	19.81	20.32	.780	.800
L1		4.50		.177
∅P	3.55	3.65	.140	.144
Q	5.89	6.40	0.232	0.252
R	4.32	5.49	.170	.216
S	6.15	BSC	242	BSC

TO-268 Outline

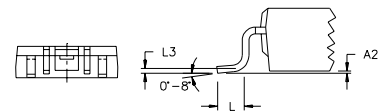
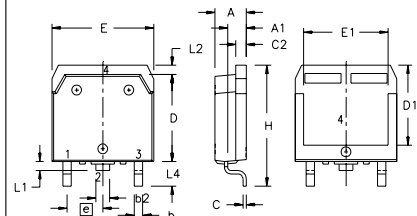

SYM	INCHES		MILLIMETERS	
	MIN	MAX	MIN	MAX
A	.193	.201	4.90	5.10
A1	.106	.114	2.70	2.90
A2	.001	.010	0.02	0.25
b	.045	.057	1.15	1.45
b2	.075	.083	1.90	2.10
C	.016	.026	0.40	0.65
C2	.057	.063	1.45	1.60
D	.543	.551	13.80	14.00
D1	.488	.500	12.40	12.70
E	.624	.632	15.85	16.05
E1	.524	.535	13.30	13.60
e	.215	BSC	5.45	BSC
H	.736	.752	18.70	19.10
L	.094	.106	2.40	2.70
L1	.047	.055	1.20	1.40
L2	.039	.045	1.00	1.15
L3	.010	BSC	0.25	BSC
L4	.150	.161	3.80	4.10

IXYS reserves the right to change limits, test conditions, and dimensions.

IXYS MOSFETs and IGBTs are covered by one or more of the following U.S. patents:

4,835,592 4,881,106 5,017,508 5,049,961 5,187,117 5,486,715 6,306,728B1 6,259,123B1 6,306,728B1
4,850,072 4,931,844 5,034,796 5,063,307 5,237,481 5,381,025 6,404,065B1 6,162,665 6,534,343

Fig. 1. Output Characteristics
@ 25 Deg. C

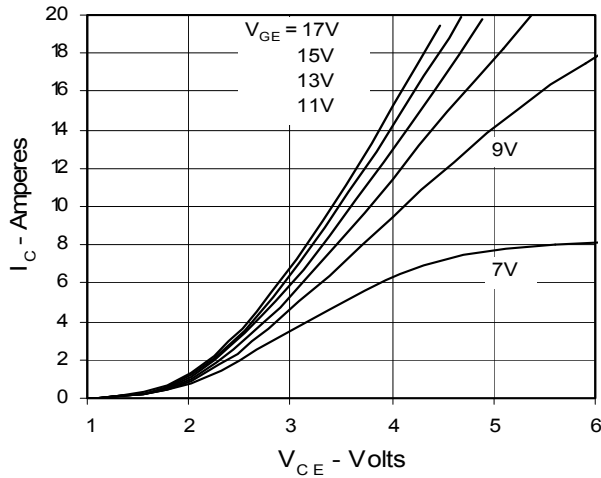

Fig. 2. Extended Output Characteristics
@ 25 deg. C

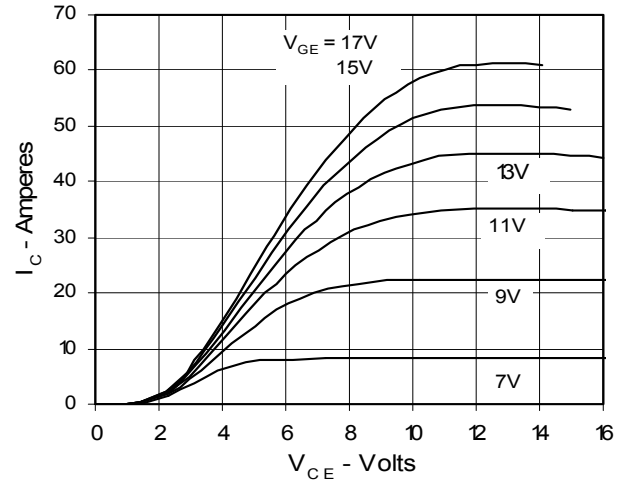

Fig. 3. Output Characteristics
@ 125 Deg. C

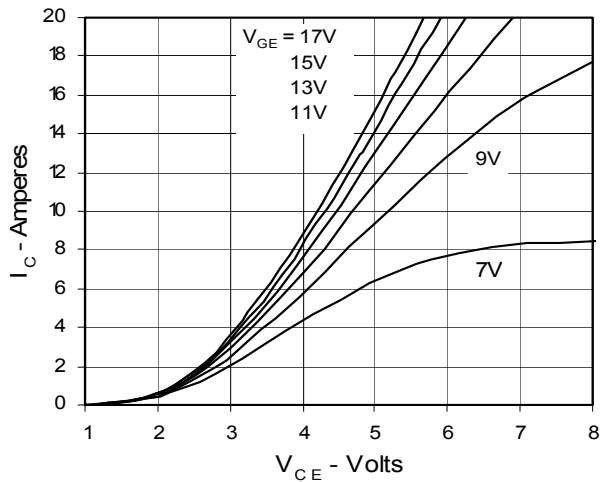

Fig. 4. Temperature Dependence of $V_{CE(sat)}$

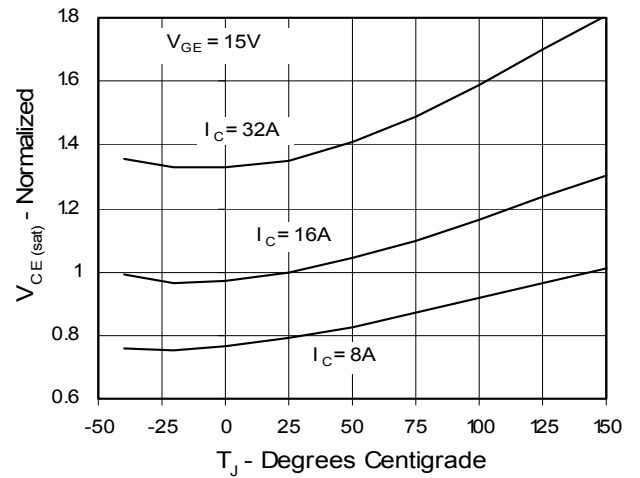

Fig. 5. Collector-to-Emitter Voltage vs. Gate-to-Emitter voltage

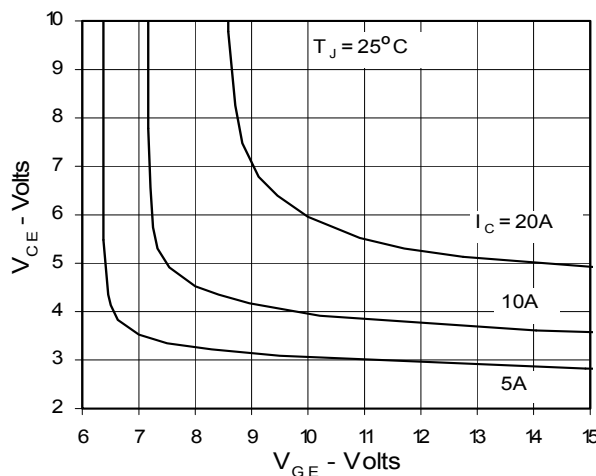

Fig. 6. Input Admittance

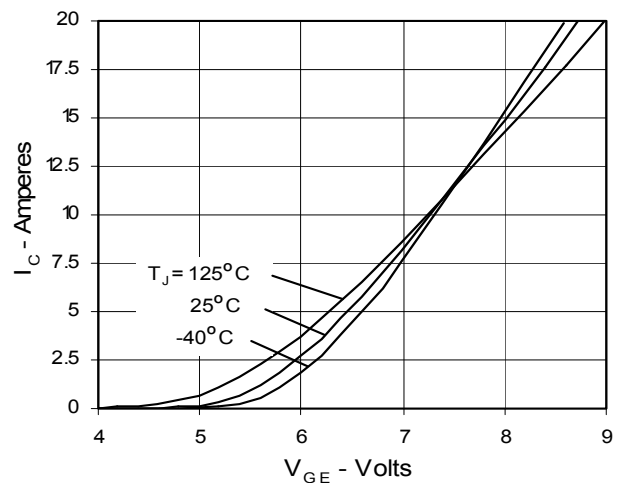

Fig. 7. Transconductance

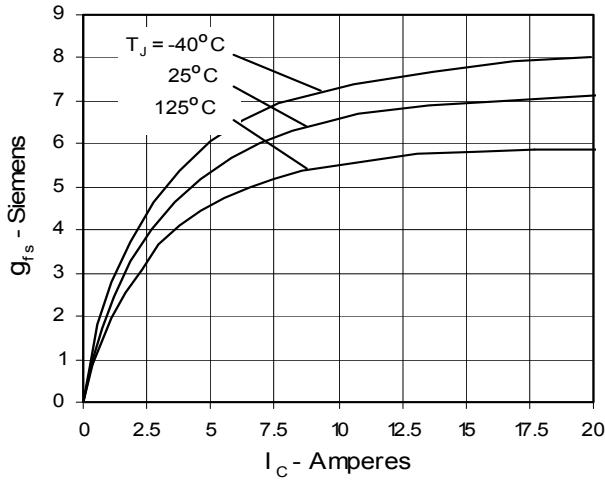

Fig. 8. Forward Voltage Drop of Intrinsic Diode

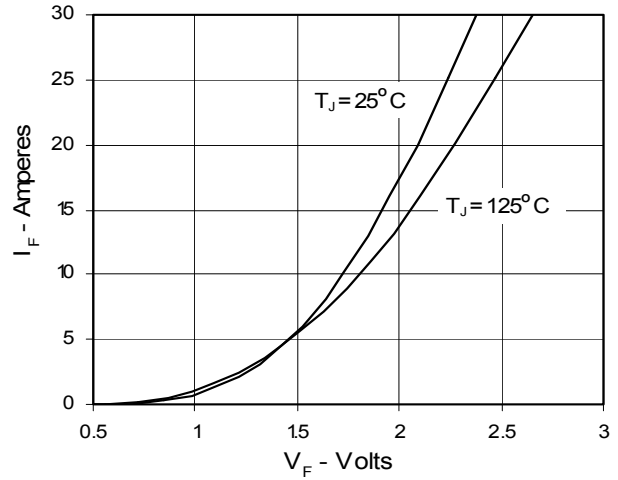

Fig. 9. Dependence of E_{off} on R_G

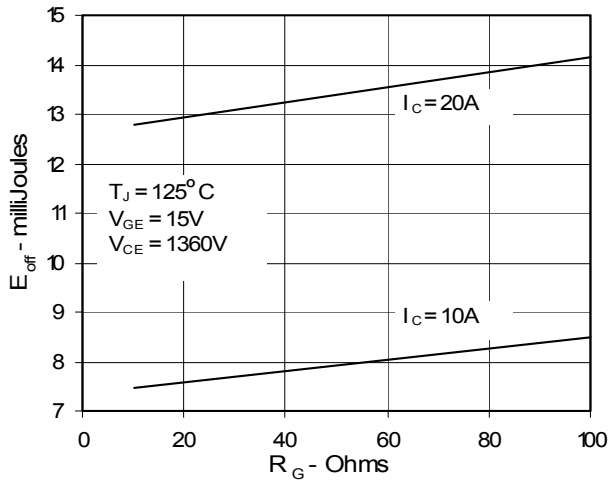

Fig. 10. Dependence of E_{off} on I_C

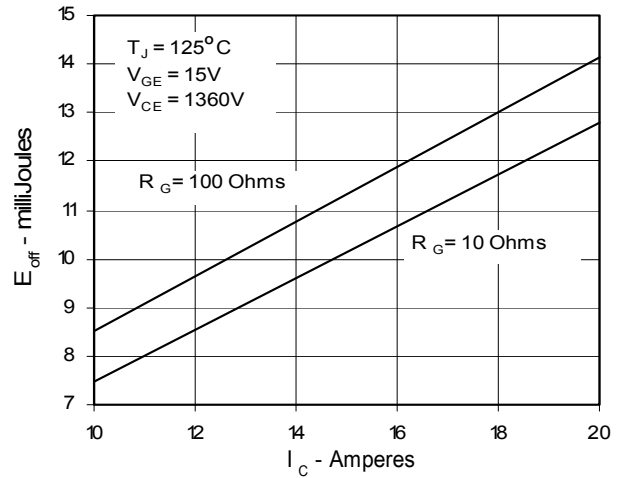

Fig. 11. Dependence of E_{off} on Temperature

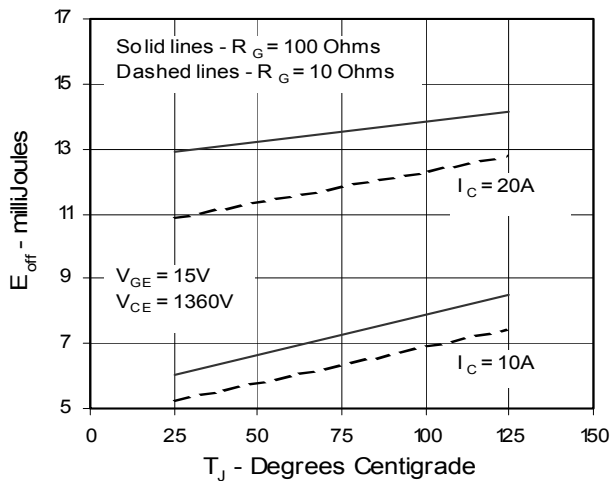
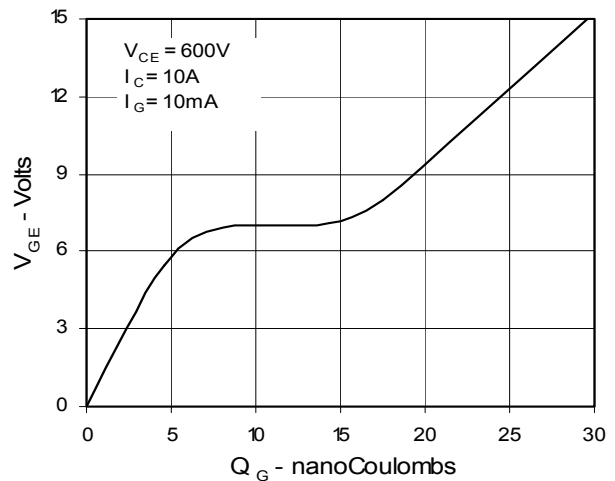

Fig. 12. Gate Charge



IXYS reserves the right to change limits, test conditions, and dimensions.

IXYS MOSFETs and IGBTs are covered by one or more of the following U.S. patents:

4,835,592 4,881,106 5,017,508 5,049,961 5,187,117 5,486,715 6,306,728B1 6,259,123B1 6,306,728B1
4,850,072 4,931,844 5,034,796 5,063,307 5,237,481 5,381,025 6,404,065B1 6,162,665 6,534,343

Fig. 12. Capacitance

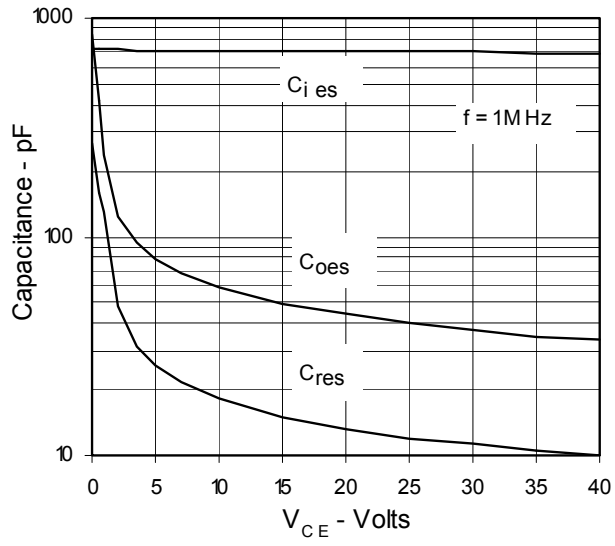

Fig. 13. Maximum Transient Thermal Resistance

