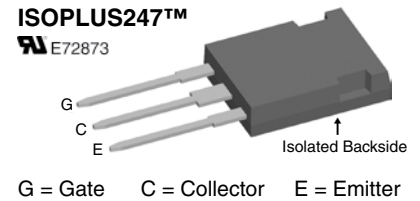
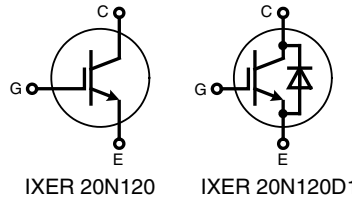

NPT³ IGBT
 in ISOPLUS247™

 $I_{C25} = 36 \text{ A}$
 $V_{CES} = 1200 \text{ V}$
 $V_{CE(sat)typ} = 2.4 \text{ V}$

IGBT		Maximum Ratings	
Symbol	Conditions		
V_{CES}	$T_{VJ} = 25^\circ\text{C to } 150^\circ\text{C}$	1200	V
V_{GES}		± 20	V
I_{C25}	$T_C = 25^\circ\text{C}$	29	A
I_{C90}	$T_C = 90^\circ\text{C}$	19	A
I_{CM} V_{CEK}	$V_{GE} = \pm 15 \text{ V}; R_G = 68 \Omega; T_{VJ} = 125^\circ\text{C}$ RBSOA Clamped inductive load; $L = 100 \mu\text{H}$	40	A
		V_{CES}	
t_{SC} (SCSOA)	$V_{CE} = 900 \text{ V}; V_{GE} = \pm 15 \text{ V}; R_G = 68 \Omega$ $T_{VJ} = 125^\circ\text{C}; \text{non-repetitive}$	10	μs
P_{tot}	$T_C = 25^\circ\text{C}$	130	W

Features

- NPT³ IGBT
 - low saturation voltage
 - positive temperature coefficient for easy paralleling
 - fast switching
 - short tail current for optimized performance in resonant circuits
- HiPerFRED™ diode
 - fast reverse recovery
 - low operating forward voltage
 - low leakage current
- ISOPLUS247™ package
 - isolated back surface
 - low coupling capacity between pins and heatsink
 - high reliability
 - industry standard outline

Symbol	Conditions	Characteristic Values				
		min.	typ.	max.		
$V_{CE(sat)}$	$I_C = 20 \text{ A}; V_{GE} = 15 \text{ V}; T_{VJ} = 25^\circ\text{C}$ $T_{VJ} = 125^\circ\text{C}$		2.4 2.8	2.8	V V	
$V_{GE(th)}$	$I_C = 0.6 \text{ mA}; V_{GE} = V_{CE}$	4.5		6.5	V	
I_{CES}	$V_{CE} = V_{CES}; V_{GE} = 0 \text{ V}; T_{VJ} = 25^\circ\text{C}$ $T_{VJ} = 125^\circ\text{C}$		0.2	0.2	mA mA	
I_{GES}	$V_{CE} = 0 \text{ V}; V_{GE} = \pm 20 \text{ V}$			200	nA	
$t_{d(on)}$ t_r $t_{d(off)}$ t_f E_{on} E_{off}	Inductive load $L = 100 \mu\text{H}; T_{VJ} = 125^\circ\text{C}$ $V_{CE} = 600 \text{ V}; I_C = 25 \text{ A}$ $V_{GE} = \pm 15 \text{ V}; R_G = 68 \Omega$		205 105 320 175 4.1 1.5		ns ns ns ns mJ mJ	
C_{ies}		$V_{CE} = 25 \text{ V}; V_{GE} = 0 \text{ V}; f = 1 \text{ MHz}$		1.2		nF
Q_{Gon}		$V_{CE} = 600 \text{ V}; V_{GE} = 15 \text{ V}; I_C = 20 \text{ A}$		100		nC
R_{thJC} R_{thCH}		with heatsink compound		0.5	0.96	K/W K/W

Applications

- single switches
- choppers with complementary free wheeling diodes
- phaselegs, H bridges, three phase bridges e.g. for
 - power supplies, UPS
 - AC, DC and SR drives
 - induction heating

Diode [D1 version only]

Symbol	Conditions	Maximum Ratings	
I_{F25}	$T_C = 25^\circ\text{C}$	25	A
I_{F90}	$T_C = 90^\circ\text{C}$	15	A

Symbol	Conditions	Characteristic Values			
		min.	typ.	max.	
V_F	$I_F = 20\text{ A}; V_{GE} = 0\text{ V};$	$T_{VJ} = 25^\circ\text{C}$	2.6	3.0	V
		$T_{VJ} = 125^\circ\text{C}$	2.0		V
I_{RM}	$V_R = 600\text{ V}; L = 100\ \mu\text{H}; T_{VJ} = 125^\circ\text{C}$		16		A
t_{rr}		$di_F/dt = -400\text{ A}/\mu\text{s}; I_F = 15\text{ A}; V_{GE} = 0\text{ V}$	130		ns
R_{thJC}	with heatsink compound		2.3		K/W
R_{thCH}			1.3		

Module

Symbol	Conditions	Maximum Ratings	
T_{VJ}		-55...+150	$^\circ\text{C}$
T_{stg}		-55...+150	$^\circ\text{C}$
V_{ISOL}	$I_{ISOL} \leq 1\text{ mA}; 50/60\text{ Hz}$	2500	V~
F_C	mounting force with clip	20...120	N

Symbol	Conditions	Characteristic Values		
		min.	typ.	max.
C_p	coupling capacity between shorted pins and mounting tab in the case		30	pF
Weight			6	g

ISOPLUS247™ Outline

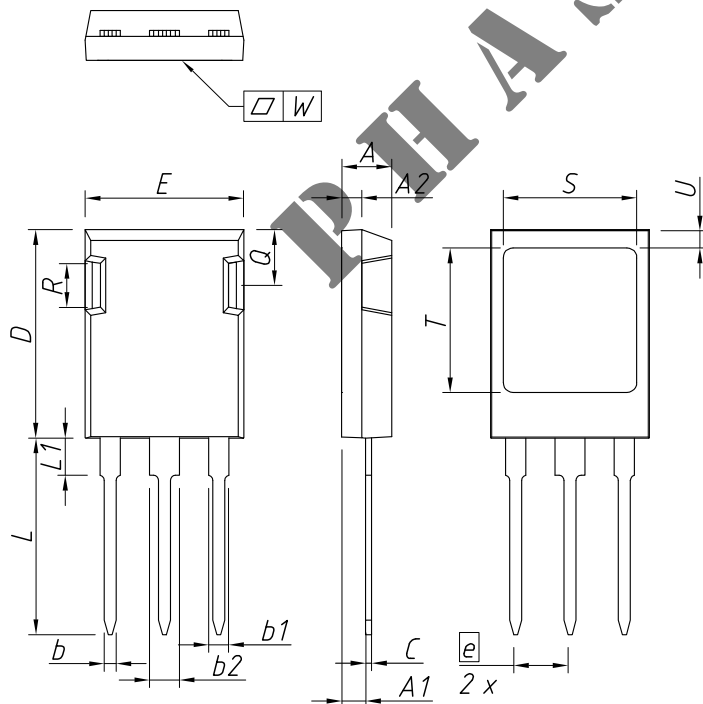

DIM.	MILLIMETER		INCHES	
	MIN	MAX	MIN	MAX
A	4,83	5,21	0,190	0,205
A1	2,29	2,54	0,090	0,100
A2	1,91	2,16	0,075	0,085
b	1,14	1,40	0,045	0,055
b1	1,91	2,15	0,075	0,085
b2	2,92	3,20	0,115	0,126
C	0,61	0,83	0,024	0,033
D	20,80	21,34	0,819	0,840
E	15,75	16,13	0,620	0,635
e	5,45 BSC		0,215 BSC	
L	19,81	20,60	0,780	0,811
L1	3,81	4,38	0,150	0,172
Q	5,59	6,20	0,220	0,244
R	4,32	4,85	0,170	0,191
S	13,21	13,72	0,520	0,540
T	15,75	16,26	0,620	0,640
U	1,65	2,03	0,065	0,080
W	-	0,10	-	0,004

Die konvexe Form des Substrates ist typ. < 0.04 mm über der Kunststoffoberfläche der Bauteilunterseite
The convex bow of substrate is typ. < 0.04 mm over plastic surface level of device bottom side

Die Gehäuseabmessungen entsprechen dem Typ TO-247 AD gemäß JEDEC außer Schraubloch und L_{max} .
This drawing will meet all dimensions requirement of JEDEC outline TO-247 AD except screw hole and except L_{max} .

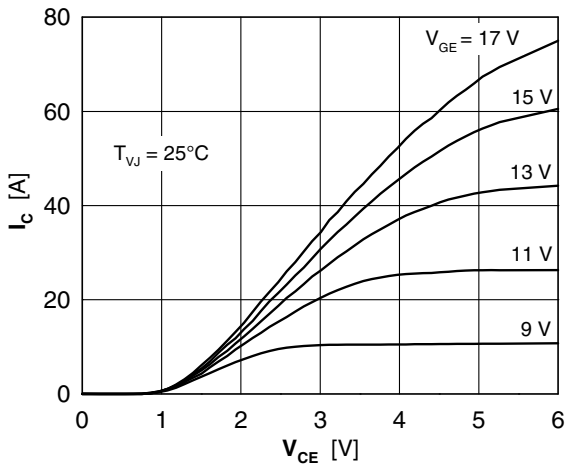

Fig. 1 Typ. output characteristics

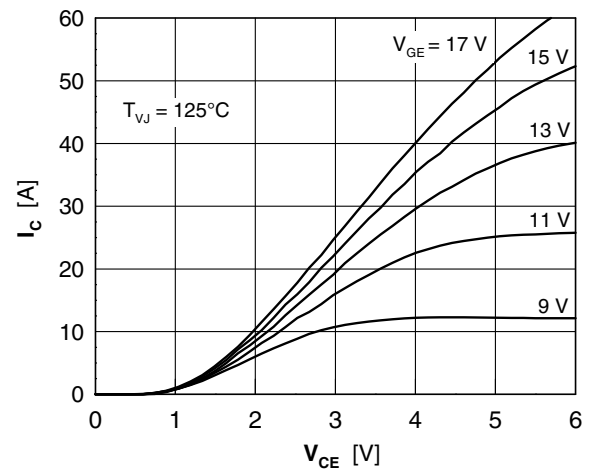

Fig. 2 Typ. output characteristics

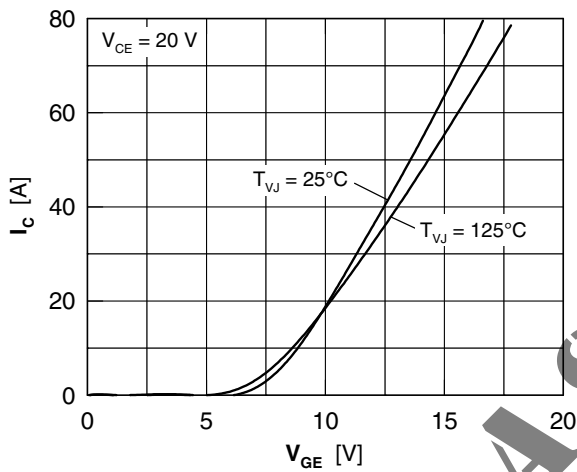

Fig. 3 Typ. transfer characteristics

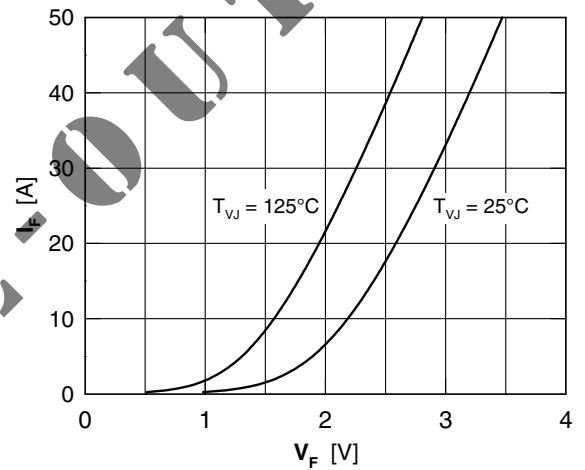

Fig. 4 Typ. forward characteristics of free wheeling diode

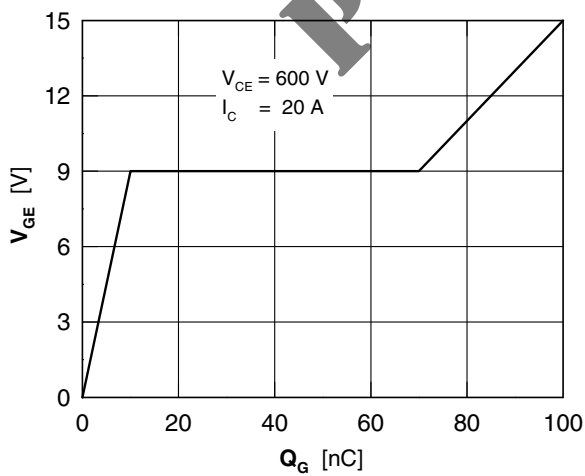

Fig. 5 Typ. turn on gate charge

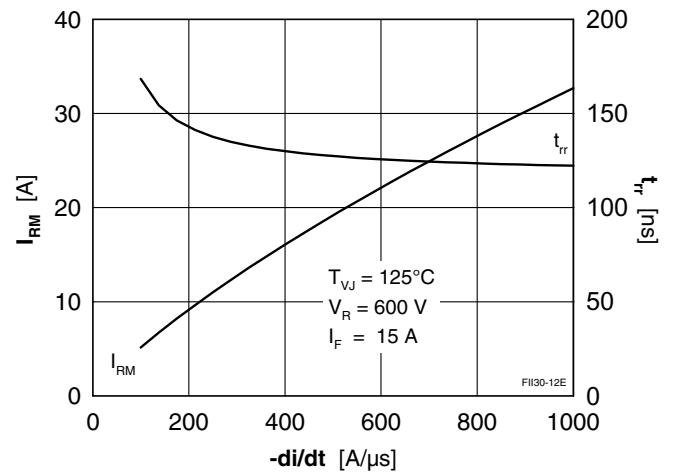

Fig. 6 Typ. turn off characteristics of free wheeling diode

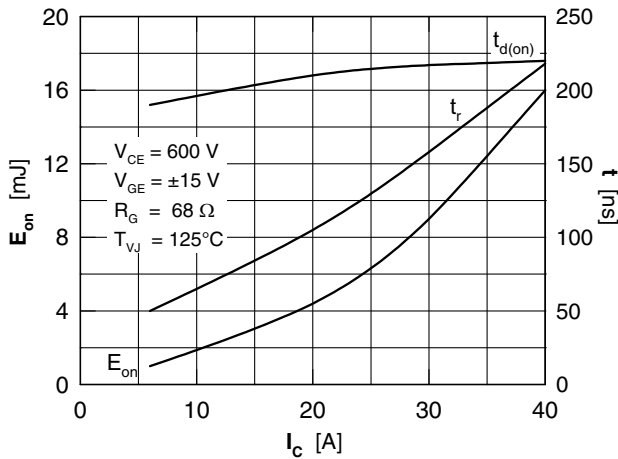

Fig. 7 Typ. turn on energy and switching times versus collector current

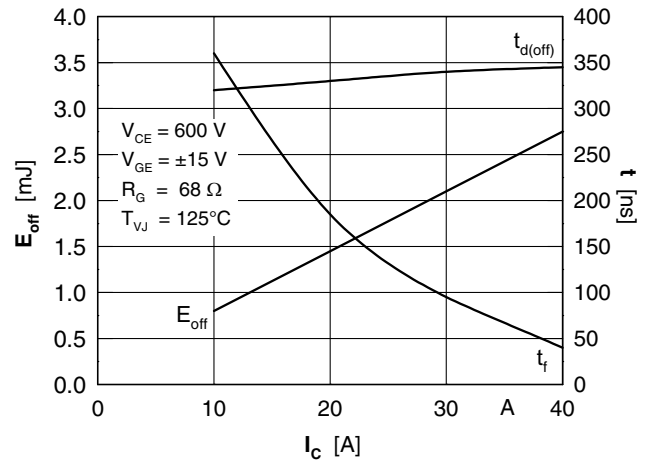

Fig. 8 Typ. turn off energy and switching times versus collector current

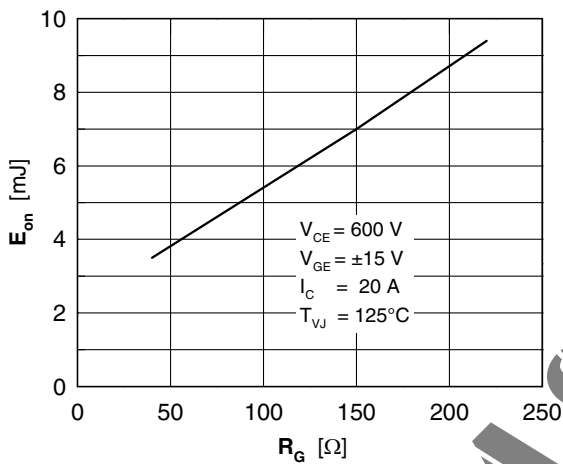

Fig. 9 Typ. turn on energy vs gate resistor

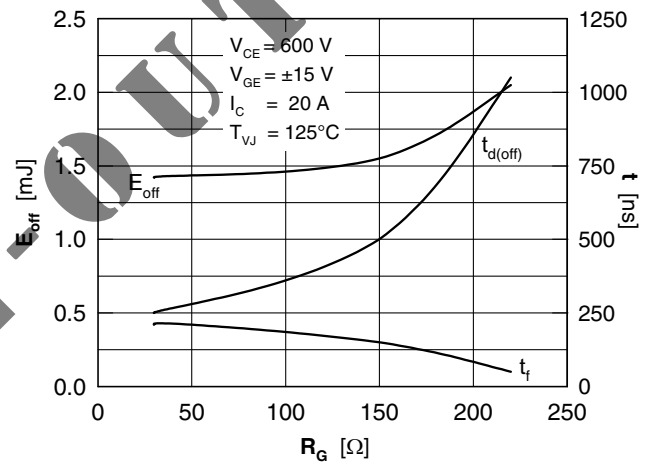

Fig. 10 Typ. turn off energy and switching times versus gate resistor

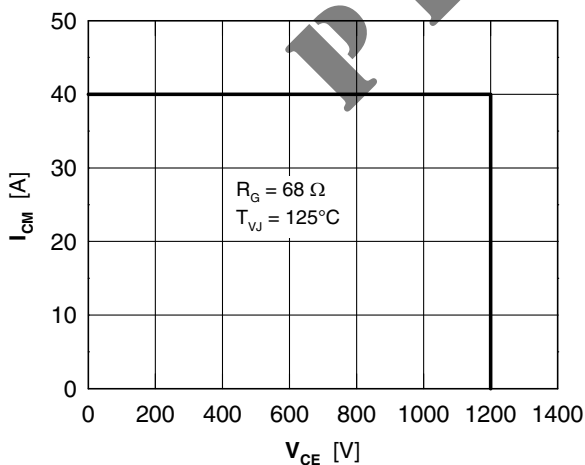

Fig. 11 Reverse biased safe operating area RBSOA

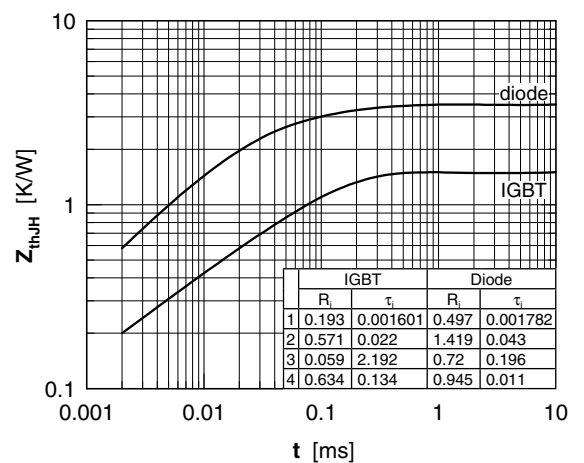

Fig. 12 Typ. transient thermal impedance

Thermal Analysis Model

$$Z_{th}(t) = \sum_{i=1}^n \left[R_i \cdot \left(1 - \exp\left(-\frac{t}{\tau_i}\right) \right) \right]$$