

# NPT<sup>3</sup> IGBT with Diode in ISOPLUS247™

$I_{C25} = 50\text{ A}$   
 $V_{CES} = 1200\text{ V}$   
 $V_{CE(sat) \text{ typ.}} = 2.2\text{ V}$

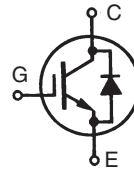

**ISOPLUS 247™**  
**E153432**

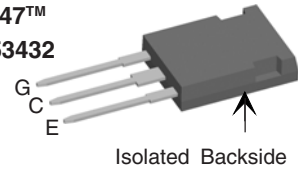

Isolated Backside

G = Gate    C = Collector    E = Emitter

## IGBT

Symbol	Conditions	Maximum Ratings	
$V_{CES}$	$T_{VJ} = 25^{\circ}\text{C to } 150^{\circ}\text{C}$	1200	V
$V_{GES}$		$\pm 20$	V
$I_{C25}$	$T_C = 25^{\circ}\text{C}$	50	A
$I_{C90}$	$T_C = 90^{\circ}\text{C}$	32	A
$I_{CM}$ $V_{CEK}$	$V_{GE} = \pm 15\text{ V}; R_G = 39\ \Omega; T_{VJ} = 125^{\circ}\text{C}$ RBSOA, Clamped inductive load; $L = 100\ \mu\text{H}$	50	A
		$V_{CES}$	
$t_{SC}$ (SCSOA)	$V_{CE} = 900\text{V}; V_{GE} = \pm 15\text{ V}; R_G = 39\ \Omega; T_{VJ} = 125^{\circ}\text{C}$ non-repetitive	10	$\mu\text{s}$
$P_{tot}$	$T_C = 25^{\circ}\text{C}$	200	W

## Features

- NPT<sup>3</sup> IGBT
  - low saturation voltage
  - positive temperature coefficient for easy paralleling
  - fast switching
  - short tail current for optimized performance in resonant circuits
- HiPerFRED™ diode
  - fast reverse recovery
  - low operating forward voltage
  - low leakage current
- ISOPLUS 247™ package
  - isolated back surface
  - low coupling capacity between pins and heatsink
  - high reliability
  - industry standard outline

Symbol	Conditions	Characteristic Values ( $T_{VJ} = 25^{\circ}\text{C}$ , unless otherwise specified)		
		min.	typ.	max.
$V_{CE(sat)}$	$I_C = 35\text{ A}; V_{GE} = 15\text{ V}; T_{VJ} = 25^{\circ}\text{C}$ $T_{VJ} = 125^{\circ}\text{C}$	2.2 2.6		V V
$V_{GE(th)}$	$I_C = 1\text{ mA}; V_{GE} = V_{CE}$	4.5		6.5 V
$I_{CES}$	$V_{CE} = V_{CES}; V_{GE} = 0\text{ V}; T_{VJ} = 25^{\circ}\text{C}$ $T_{VJ} = 125^{\circ}\text{C}$	0.4		0.4 mA mA
$I_{GES}$	$V_{CE} = 0\text{ V}; V_{GE} = \pm 20\text{ V}$			200 nA
$t_{d(on)}$ $t_r$ $t_{d(off)}$ $t_f$	Inductive load, $T_{VJ} = 125^{\circ}\text{C}$ $V_{CE} = 600\text{ V}; I_C = 35\text{ A}$ $V_{GE} = \pm 15\text{ V}; R_G = 39\ \Omega$	85		ns
		50		ns
		440		ns
		50		ns
$E_{on}$ $E_{off}$		5.4 2.6		mJ mJ
$C_{ies}$	$V_{CE} = 25\text{ V}; V_{GE} = 0\text{ V}; f = 1\text{ MHz}$	2		nF
$Q_{Gon}$	$V_{CE} = 600\text{ V}; V_{GE} = 15\text{ V}; I_C = 35\text{ A}$	150		nC
$R_{thJC}$ $R_{thCH}$	with heatsink compound	0.3		0.6 KW KW

## Applications

- single switches
- choppers with complementary free wheeling diodes
- phaselegs, H bridges, three phase bridges e.g. for
  - power supplies, UPS
  - AC, DC and SR drives
  - induction heating

## Diode

Symbol	Conditions	Maximum Ratings	
$I_{F25}$	$T_C = 25^\circ\text{C}$	48	A
$I_{F90}$	$T_C = 90^\circ\text{C}$	25	A

Symbol	Conditions	Characteristic Values		
		min.	typ.	max.
$V_F$	$I_F = 35\text{ A}; T_{VJ} = 25^\circ\text{C}$ $T_{VJ} = 125^\circ\text{C}$	2.5 1.9	2.9	V V
$I_{RM}$ $t_{rr}$ $E_{rec(off)}$	$I_F = 30\text{ A}; di_F/dt = -1100\text{ A}/\mu\text{s}; T_{VJ} = 125^\circ\text{C}$ $V_R = 600\text{ V}; V_{GE} = 0\text{ V}$	51	A	
		80	ns	
		1.8	mJ	
$R_{thJC}$ $R_{thCH}$	with heatsink compound	0.6	1.2 K/W	K/W

## Component

Symbol	Conditions	Maximum Ratings	
$T_{VJ}$		-55...+150	$^\circ\text{C}$
$T_{stg}$		-55...+125	$^\circ\text{C}$
$V_{ISOL}$	$I_{ISOL} \leq 1\text{ mA}; 50/60\text{ Hz}$	2500	V~
$F_c$	mounting force with clip	20...120	N

Symbol	Conditions	Characteristic Values		
		min.	typ.	max.
$C_p$	coupling capacity between shorted pins and mounting tab in the case		30	pF
Weight			6	g

## Equivalent Circuits for Simulation

### Conduction

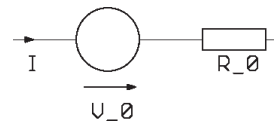

IGBT (typ. at  $V_{GE} = 15\text{ V}; T_J = 125^\circ\text{C}$ )  
 $V_0 = 0.95\text{ V}; R_0 = 45\text{ m}\Omega$

Diode (typ. at  $T_J = 125^\circ\text{C}$ )  
 $V_0 = 1.26\text{ V}; R_0 = 15\text{ m}\Omega$

### Thermal Response

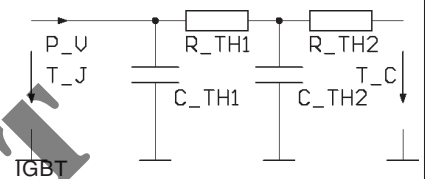

IGBT  
 $C_{th1} = 0.067\text{ J/K}; R_{th1} = 0.108\text{ K/W}$   
 $C_{th2} = 0.175\text{ J/K}; R_{th2} = 0.491\text{ K/W}$

Diode  
 $C_{th1} = 0.039\text{ J/K}; R_{th1} = 0.311\text{ K/W}$   
 $C_{th2} = 0.090\text{ J/K}; R_{th2} = 0.889\text{ K/W}$

## ISOPLUS247™ OUTLINE

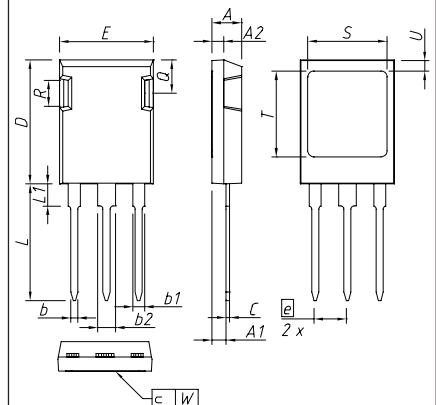

DIM.	MILLIMETER		INCHES	
	MIN	MAX	MIN	MAX
A	4,83	5,21	0,190	0,205
A1	2,29	2,54	0,090	0,100
A2	1,91	2,16	0,075	0,085
b	1,14	1,40	0,045	0,055
b1	1,91	2,15	0,075	0,085
b2	2,92	3,20	0,115	0,126
C	0,61	0,83	0,024	0,033
D	20,80	21,34	0,819	0,840
E	15,75	16,13	0,620	0,635
e	5,45 BSC		0,215 BSC	
L	19,81	20,60	0,780	0,811
L1	3,81	4,38	0,150	0,172
Q	5,59	6,20	0,220	0,244
R	4,32	4,85	0,170	0,191
S	13,21	13,72	0,520	0,540
T	15,75	16,26	0,620	0,640
U	1,65	2,03	0,065	0,080
W	-	0,10	-	0,004

The convex bow of substrate is typ. < 0.04 mm over plastic surface level of device bottom side  
This drawing will meet all dimensions requirement of JEDEC outline TO-247 AD except screw hole and except Lmax.

0644

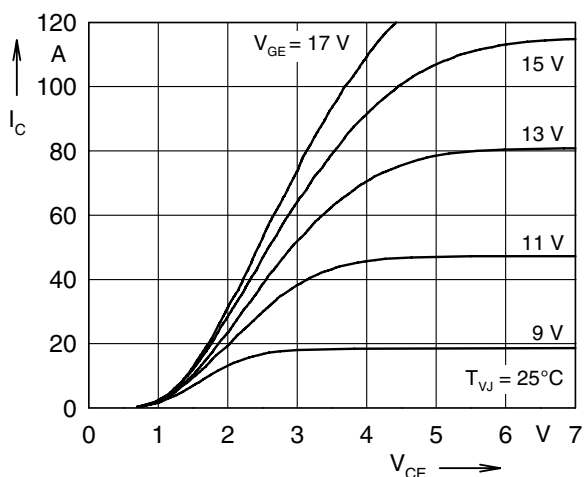

Fig. 1 Typ. output characteristics

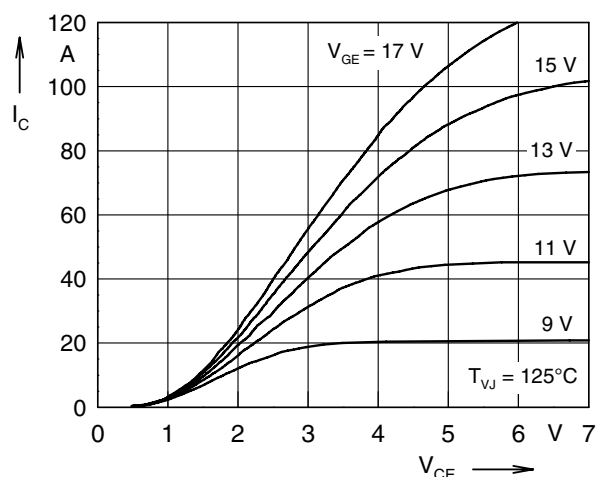

Fig. 2 Typ. output characteristics

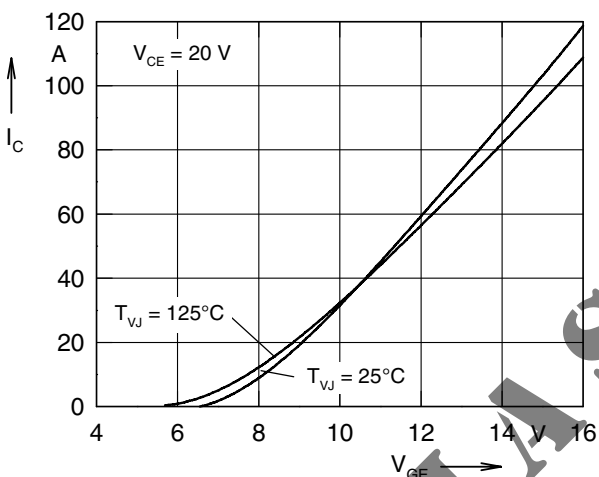

Fig. 3 Typ. transfer characteristics

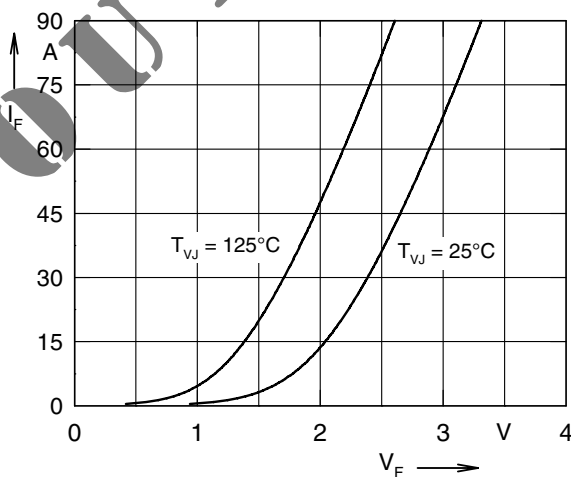

Fig. 4 Typ. forward characteristics of free wheeling diode

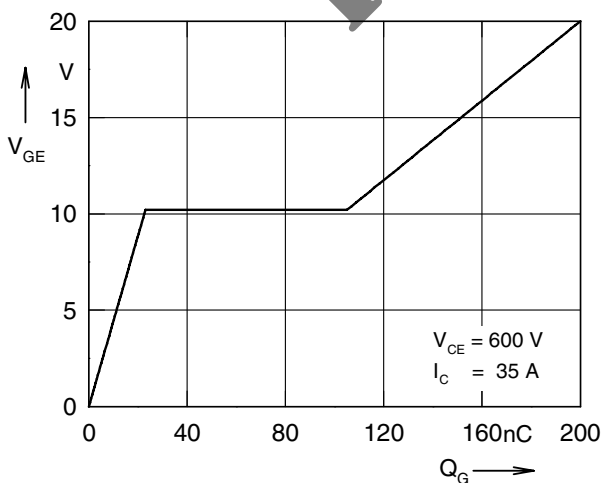

Fig. 5 Typ. turn on gate charge

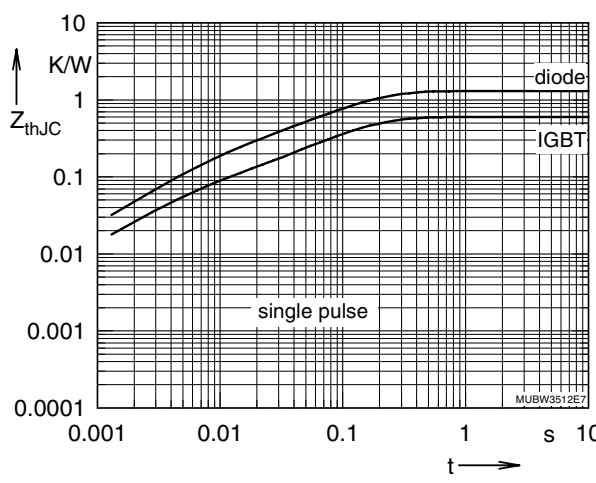

Fig. 6 Typ. transient thermal impedance

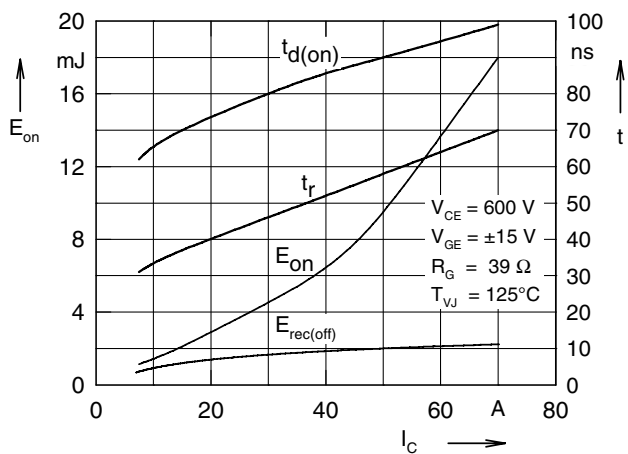

Fig. 7 Typ. turn on energy and switching times versus collector current

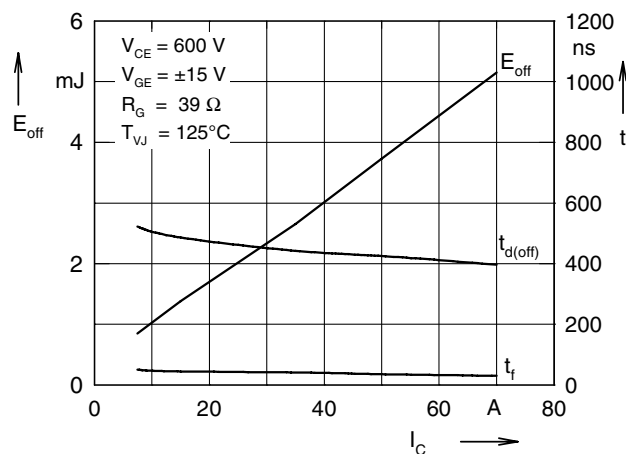

Fig. 8 Typ. turn off energy and switching times versus collector current

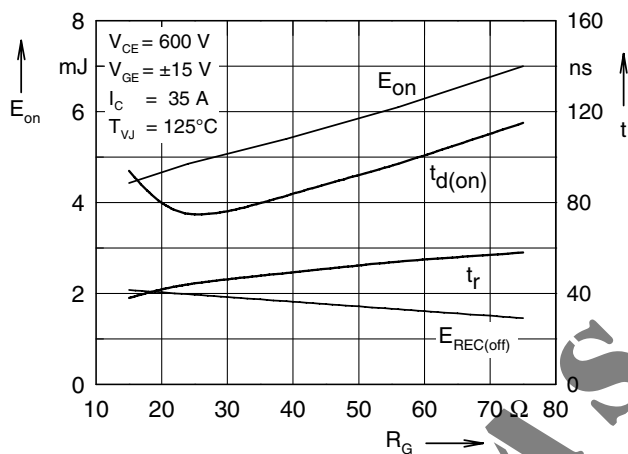

Fig. 9 Typ. turn on energy and switching times versus gate resistor

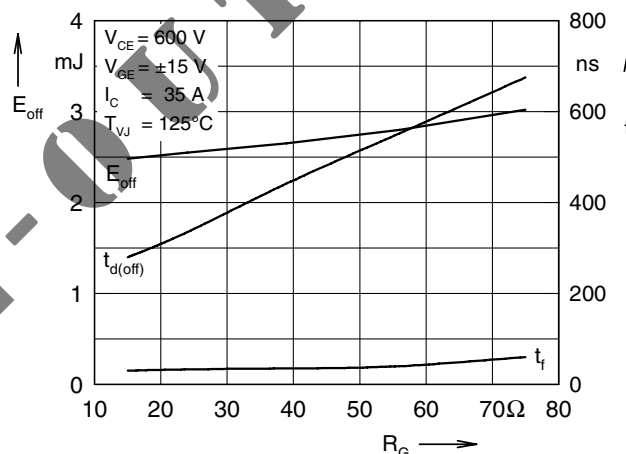

Fig. 10 Typ. turn off energy and switching times versus gate resistor

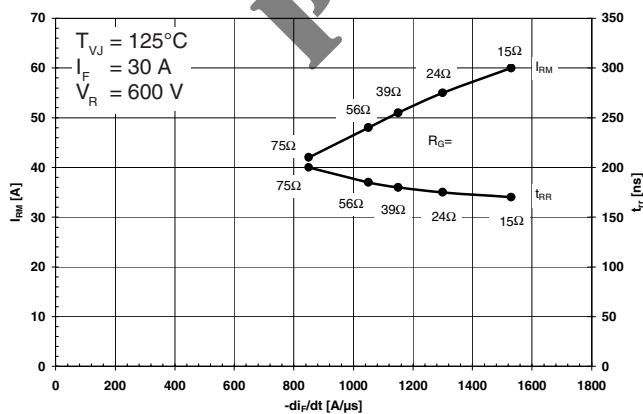

Fig. 11 Typ. turn off characteristics of free wheeling diode

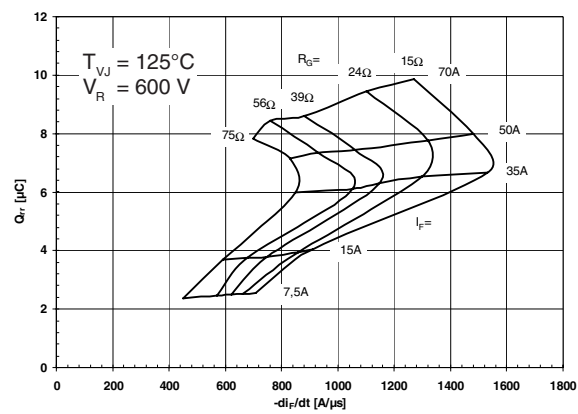

Fig. 12 Typ. turn off characteristics of free wheeling diode