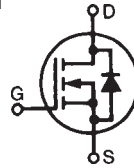

Polar™ Power MOSFET
HiPerFET™
IXFA5N100P
IXFH5N100P
IXFP5N100P

 N-Channel Enhancement Mode
 Avalanche Rated
 Fast Intrinsic Diode

$$V_{DSS} = 1000V$$

$$I_{D25} = 5A$$

$$R_{DS(on)} \leq 2.8\Omega$$

| Symbol | Test Conditions | Maximum Ratings | |
|---------------|--|-----------------|------------|
| V_{DSS} | $T_J = 25^\circ C$ to $150^\circ C$ | 1000 | V |
| V_{DGR} | $T_J = 25^\circ C$ to $150^\circ C$, $R_{GS} = 1M\Omega$ | 1000 | V |
| V_{GSS} | Continuous | ± 30 | V |
| V_{GSM} | Transient | ± 40 | V |
| I_{D25} | $T_C = 25^\circ C$ | 5 | A |
| I_{DM} | $T_C = 25^\circ C$, pulse width limited by T_{JM} | 10 | A |
| I_A | $T_C = 25^\circ C$ | 5 | A |
| E_{AS} | $T_C = 25^\circ C$ | 300 | mJ |
| dV/dt | $I_S \leq I_{DM}$, $V_{DD} \leq V_{DSS}$, $T_J \leq 150^\circ C$ | 10 | V/ns |
| P_D | $T_C = 25^\circ C$ | 250 | W |
| T_J | | -55 ... +150 | $^\circ C$ |
| T_{JM} | | 150 | $^\circ C$ |
| T_{stg} | | -55 ... +150 | $^\circ C$ |
| T_L | 1.6mm (0.062) from case for 10s | 300 | $^\circ C$ |
| T_{SOLD} | Plastic body for 10s | 260 | $^\circ C$ |
| M_d | Mounting torque (TO-220, TO-247) | 1.13 / 10 | Nm/lb.in. |
| Weight | TO-263 | 2.5 | g |
| | TO-220 | 3.0 | g |
| | TO-247 | 6.0 | g |

TO-263 (IXFA)

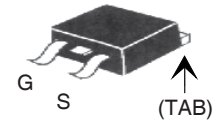

TO-247 (IXFH)

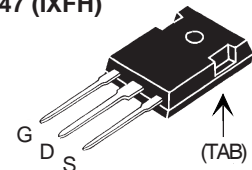

TO-220 (IXFP)

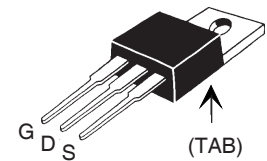
 G = Gate D = Drain
 S = Source TAB = Drain

Features

- International standard packages
- Dynamic dv/dt Rating
- Avalanche Rated
- Low $R_{DS(ON)}$, rugged Polar™ process
- Low Q_G
- Low Drain-to-Tab capacitance
- Low package inductance

Advantages

- Easy to mount
- Space savings

Applications:

- DC-DC converters
- Battery chargers
- Switched-mode and resonant-mode power supplies
- Uninterrupted power supplies
- AC motor control
- High speed power switching applications

| Symbol | Test Conditions ($T_J = 25^\circ C$, unless otherwise specified) | Characteristic Values | | |
|--------------|---|-----------------------|------|--------------|
| | | Min. | Typ. | Max. |
| BV_{DSS} | $V_{GS} = 0V$, $I_D = 250\mu A$ | 1000 | | V |
| $V_{GS(th)}$ | $V_{DS} = V_{GS}$, $I_D = 250\mu A$ | 3.0 | | 6.0 V |
| I_{GSS} | $V_{GS} = \pm 30V$, $V_{DS} = 0V$ | | | ± 100 nA |
| I_{DSS} | $V_{DS} = V_{DSS}$ | | | 10 μA |
| | $V_{GS} = 0V$ $T_J = 125^\circ C$ | | | 750 μA |
| $R_{DS(on)}$ | $V_{GS} = 10V$, $I_D = 0.5 \cdot I_{D25}$, Note 1 | | | 2.8 Ω |

| Symbol | Test Conditions ($T_J = 25^\circ\text{C}$, unless otherwise specified) | Characteristic Values | | |
|--------------|--|-----------------------|------|-------------------------|
| | | Min. | Typ. | Max |
| g_{fs} | $V_{DS} = 20\text{V}$, $I_D = 0.5 \cdot I_{D25}$, Note 1 | 2.4 | 4.0 | S |
| R_{Gi} | Gate input resistance | | 1.6 | Ω |
| C_{iss} | $V_{GS} = 0\text{V}$, $V_{DS} = 25\text{V}$, $f = 1\text{MHz}$ | | 1830 | pF |
| C_{oss} | | | 113 | pF |
| C_{rss} | | | 20 | pF |
| $t_{d(on)}$ | Resistive Switching Times $V_{GS} = 10\text{V}$, $V_{DS} = 0.5 \cdot V_{DSS}$, $I_D = 0.5 \cdot I_{D25}$ $R_G = 5\Omega$ (External) | | 12 | ns |
| t_r | | | 13 | ns |
| $t_{d(off)}$ | | | 30 | ns |
| t_f | | | 37 | ns |
| $Q_{g(on)}$ | $V_{GS} = 10\text{V}$, $V_{DS} = 0.5 \cdot V_{DSS}$, $I_D = 0.5 \cdot I_{D25}$ | | 33.4 | nC |
| Q_{gs} | | | 10.6 | nC |
| Q_{gd} | | | 14.4 | nC |
| R_{thJC} | | | | 0.50 $^\circ\text{C/W}$ |
| R_{thCS} | (TO-220) | | 0.50 | $^\circ\text{C/W}$ |
| R_{thCS} | (TO-247) | | 0.25 | $^\circ\text{C/W}$ |

Source-Drain Diode

Characteristic Values
($T_J = 25^\circ\text{C}$, unless otherwise specified)

| Symbol | Test Conditions | Min. | Typ. | Max. |
|----------|---|------|------|---------------|
| I_S | $V_{GS} = 0\text{V}$ | | | 5 A |
| I_{SM} | Repetitive, pulse width limited by T_{JM} | | | 20 A |
| V_{SD} | $I_F = I_S$, $V_{GS} = 0\text{V}$, Note 1 | | | 1.3 V |
| t_{rr} | $I_F = 5\text{A}$, $V_{GS} = 0\text{V}$ $-di/dt = 100\text{A}/\mu\text{s}$ $V_R = 100\text{V}$ | | | 200 ns |
| I_{RM} | | | 7.4 | A |
| Q_{RM} | | | 0.43 | μC |

Note 1: Pulse test, $t \leq 300\mu\text{s}$; duty cycle, $d \leq 2\%$.

TO-263 (IXFA) Outline

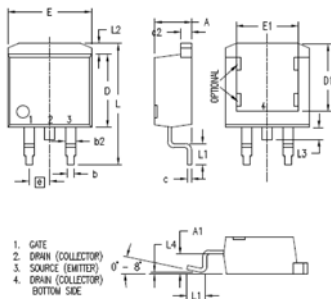

| SYM | INCHES | | MILLIMETERS | |
|-----|----------|------|-------------|-------|
| | MIN | MAX | MIN | MAX |
| A | .160 | .190 | 4.06 | 4.83 |
| A1 | .080 | .110 | 2.03 | 2.79 |
| b | .020 | .039 | 0.51 | 0.99 |
| b1 | .045 | .055 | 1.14 | 1.40 |
| b2 | .045 | .055 | 1.14 | 1.40 |
| c | .016 | .029 | 0.40 | 0.74 |
| c1 | .045 | .055 | 1.14 | 1.40 |
| c2 | .045 | .055 | 1.14 | 1.40 |
| D | .340 | .380 | 8.64 | 9.65 |
| D1 | .315 | .350 | 8.00 | 8.89 |
| E | .380 | .410 | 9.65 | 10.41 |
| E1 | .245 | .320 | 6.22 | 8.13 |
| e | .100 BSC | | 2.54 BSC | |
| L | .575 | .625 | 14.61 | 15.88 |
| L1 | .090 | .110 | 2.29 | 2.79 |
| L2 | .040 | .055 | 1.02 | 1.40 |
| L3 | .050 | .070 | 1.27 | 1.78 |
| L4 | 0 | .005 | 0 | 0.13 |

PRELIMINARY TECHNICAL INFORMATION

The product presented herein is under development. The Technical Specifications offered are derived from data gathered during objective characterizations of preliminary engineering lots; but also may yet contain some information supplied during a pre-production design evaluation. IXYS reserves the right to change limits, test conditions, and dimensions without notice.

IXYS reserves the right to change limits, test conditions, and dimensions.

| | | | | | | | | | | |
|--|-----------|-----------|-----------|-----------|-------------|-------------|-------------|-------------|-------------|-------------|
| IXYS MOSFETs and IGBTs are covered by one or more of the following U.S. patents: | 4,835,592 | 4,931,844 | 5,049,961 | 5,237,481 | 6,162,665 | 6,404,065B1 | 6,683,344 | 6,727,585 | 7,005,734B2 | 7,157,338B2 |
| | 4,850,072 | 5,017,508 | 5,063,307 | 5,381,025 | 6,259,123B1 | 6,534,343 | 6,710,405B2 | 6,759,692 | 7,063,975B2 | |
| | 4,881,106 | 5,034,796 | 5,187,117 | 5,486,715 | 6,306,728B1 | 6,583,505 | 6,710,463 | 6,771,478B2 | 7,071,537 | |

TO-247 (IXFH) Outline

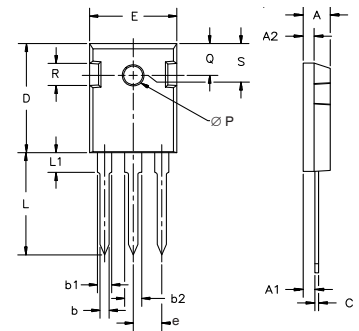

| Dim. | Millimeter | | Inches | |
|----------|------------|-------|--------|-------|
| | Min. | Max. | Min. | Max. |
| A | 4.7 | 5.3 | .185 | .209 |
| A1 | 2.2 | 2.54 | .087 | .102 |
| A2 | 2.2 | 2.6 | .059 | .098 |
| b | 1.0 | 1.4 | .040 | .055 |
| b1 | 1.65 | 2.13 | .065 | .084 |
| b2 | 2.87 | 3.12 | .113 | .123 |
| C | .4 | .8 | .016 | .031 |
| D | 20.80 | 21.46 | .819 | .845 |
| E | 15.75 | 16.26 | .610 | .640 |
| e | 5.20 | 5.72 | 0.205 | 0.225 |
| L | 19.81 | 20.32 | .780 | .800 |
| L1 | | 4.50 | | .177 |
| ϕP | 3.55 | 3.65 | .140 | .144 |
| Q | 5.89 | 6.40 | 0.232 | 0.252 |
| R | 4.32 | 5.49 | .170 | .216 |
| S | 6.15 | BSC | 242 | BSC |

TO-220 (IXFP) Outline

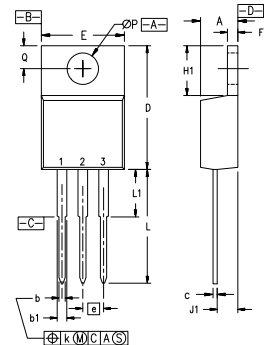

Pins: 1 - Gate 2 - Drain

| SYM | INCHES | | MILLIMETERS | |
|----------|----------|------|-------------|-------|
| | MIN | MAX | MIN | MAX |
| A | .170 | .190 | 4.32 | 4.83 |
| b | .025 | .040 | 0.64 | 1.02 |
| b1 | .045 | .065 | 1.15 | 1.65 |
| c | .014 | .022 | 0.35 | 0.56 |
| D | 5.80 | 6.30 | 14.73 | 16.00 |
| E | .390 | .420 | 9.91 | 10.66 |
| e | .100 BSC | | 2.54 BSC | |
| F | .045 | .055 | 1.14 | 1.40 |
| H1 | .230 | .270 | 5.85 | 6.85 |
| J1 | .090 | .110 | 2.29 | 2.79 |
| k | 0 | .015 | 0 | 0.38 |
| L | .500 | .550 | 12.70 | 13.97 |
| L1 | .110 | .230 | 2.79 | 5.84 |
| ϕP | .139 | .161 | 3.53 | 4.08 |
| Q | .100 | .125 | 2.54 | 3.18 |

Fig. 1. Output Characteristics @ 25°C

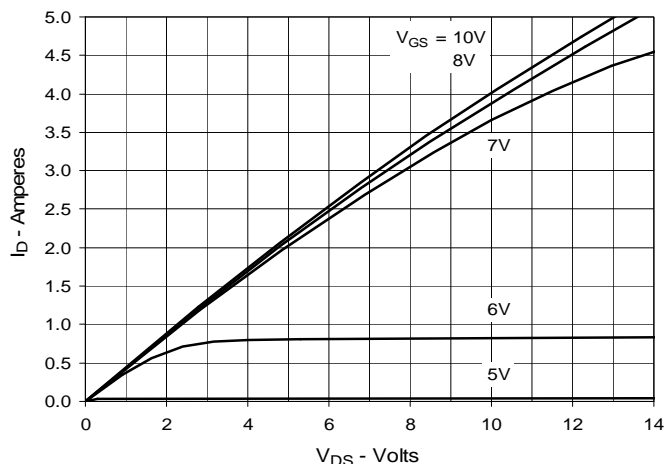

Fig. 2. Extended Output Characteristics @ 25°C

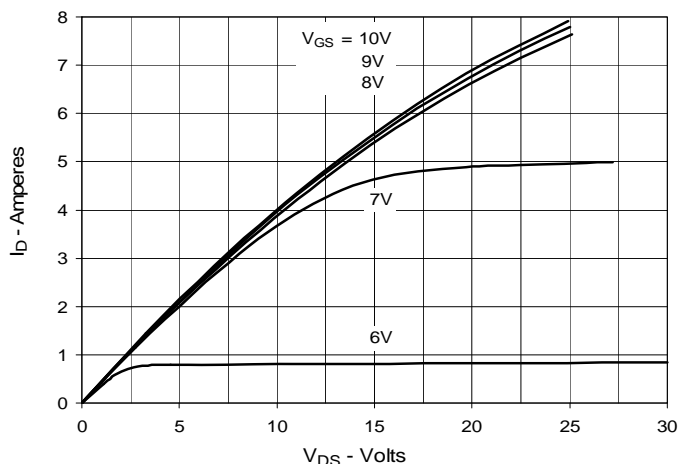

Fig. 3. Output Characteristics @ 125°C

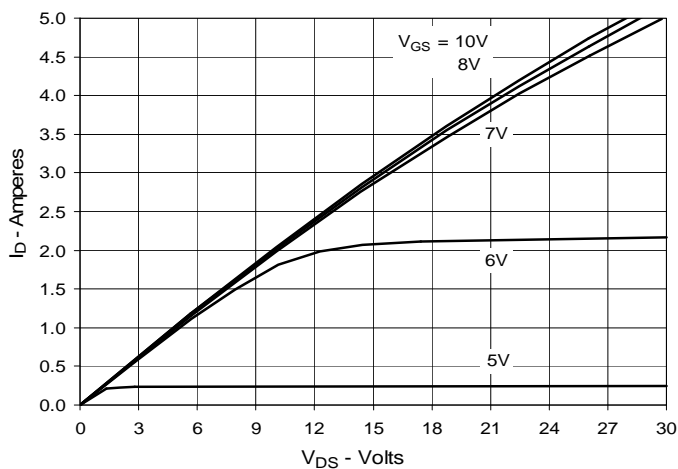

Fig. 4. $R_{DS(on)}$ Normalized to $I_D = 2.5A$ Value vs. Junction Temperature

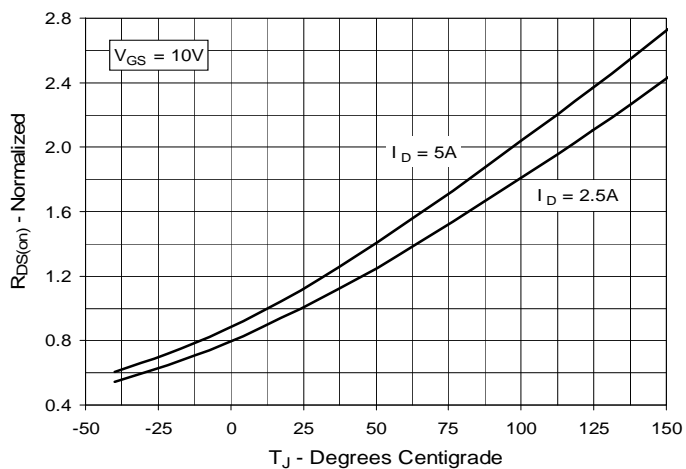

Fig. 5. $R_{DS(on)}$ Normalized to $I_D = 2.5A$ Value vs. Drain Current

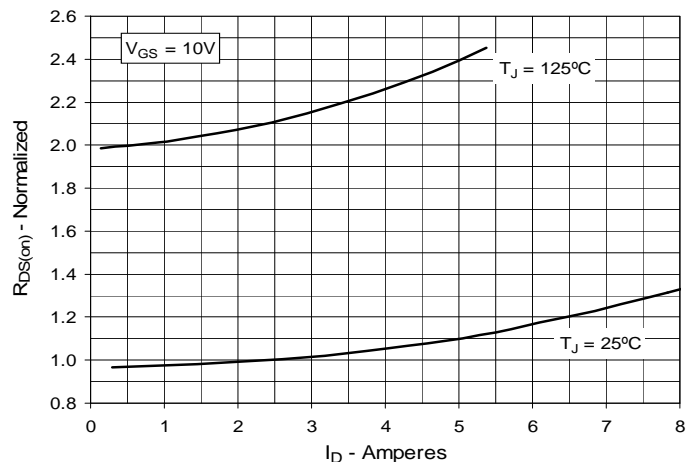

Fig. 6. Maximum Drain Current vs. Case Temperature

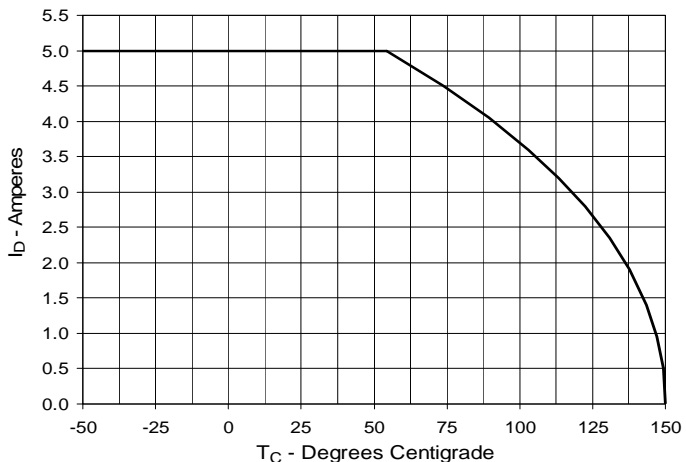

Fig. 7. Input Admittance

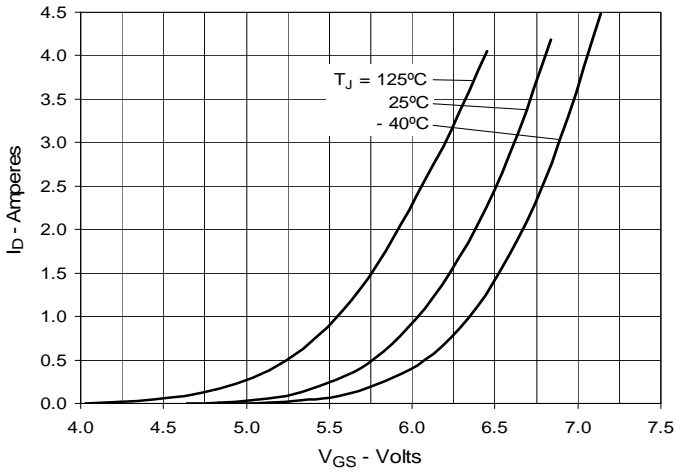

Fig. 8. Transconductance

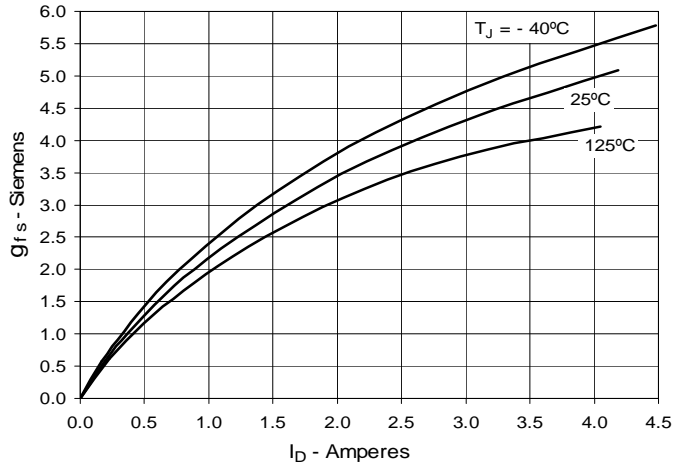

Fig. 9. Forward Voltage Drop of Intrinsic Diode

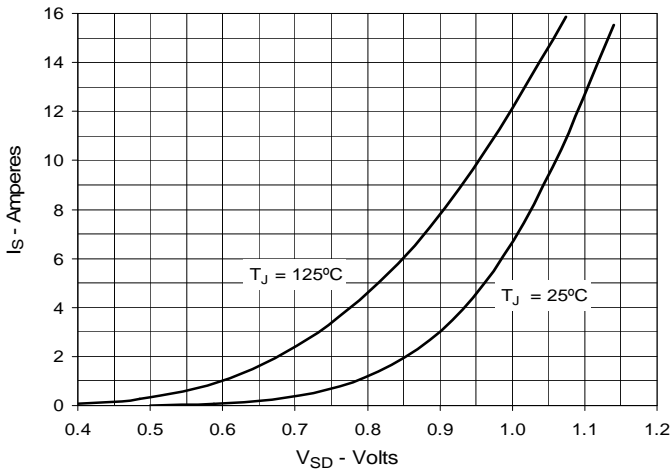

Fig. 10. Gate Charge

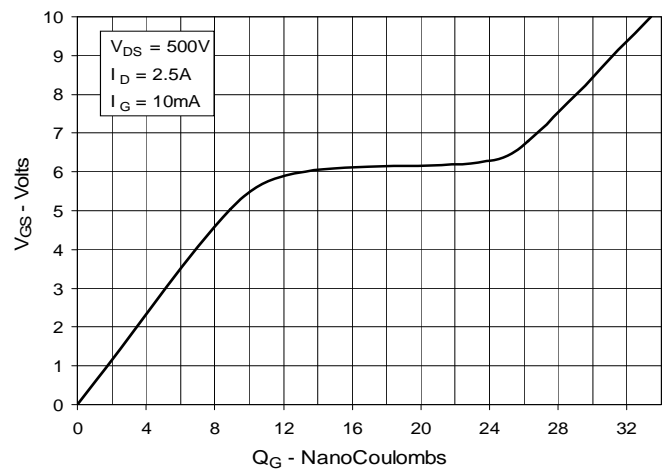

Fig. 11. Capacitance

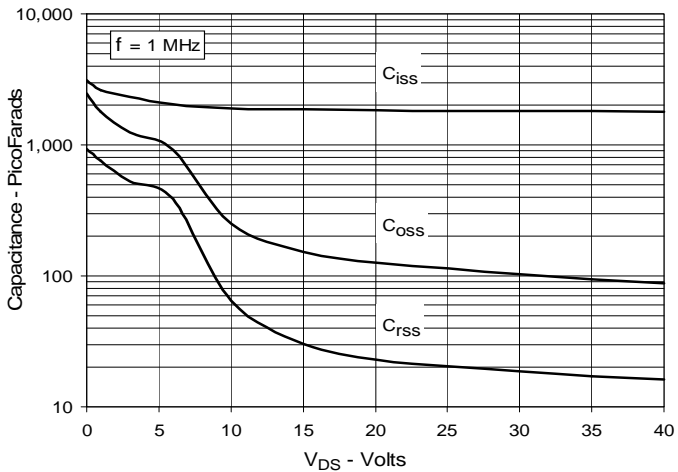

Fig. 12. Maximum Transient Thermal Impedance

