

# PolarHV™ HiPerFET Power MOSFET

## IXFB 82N60P

$V_{DSS} = 600 \text{ V}$   
 $I_{D25} = 82 \text{ A}$   
 $R_{DS(on)} \leq 75 \text{ m}\Omega$   
 $t_{rr} \leq 200 \text{ ns}$

N-Channel Enhancement Mode  
 Avalanche Rated  
 Fast Intrinsic Diode

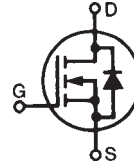

Symbol	Test Conditions	Maximum Ratings	
$V_{DSS}$	$T_J = 25^\circ\text{C}$ to $150^\circ\text{C}$	600	V
$V_{DGR}$	$T_J = 25^\circ\text{C}$ to $150^\circ\text{C}$ ; $R_{GS} = 1 \text{ M}\Omega$	600	V
$V_{GSS}$	Continuous	$\pm 30$	V
$V_{GSM}$	Transient	$\pm 40$	V
$I_{D25}$	$T_C = 25^\circ\text{C}$	82	A
$I_{DRMS}$	External lead current limit	75	A
$I_{DM}$	$T_C = 25^\circ\text{C}$ , pulse width limited by $T_{JM}$	200	A
$I_{AR}$	$T_C = 25^\circ\text{C}$	82	A
$E_{AR}$	$T_C = 25^\circ\text{C}$	100	mJ
$E_{AS}$	$T_C = 25^\circ\text{C}$	5	J
$dv/dt$	$I_S \leq I_{DM}$ , $di/dt \leq 100 \text{ A}/\mu\text{s}$ , $V_{DD} \leq V_{DSS}$ , $T_J \leq 150^\circ\text{C}$ , $R_G = 2 \Omega$	20	V/ns
$P_D$	$T_C = 25^\circ\text{C}$	1250	W
$T_J$		-55 ... +150	$^\circ\text{C}$
$T_{JM}$		150	$^\circ\text{C}$
$T_{stg}$		-55 ... +150	$^\circ\text{C}$
$T_L$	1.6 mm (0.062 in.) from case for 10 s	300	$^\circ\text{C}$
$T_{SOLD}$	Plastic body for 10 s	260	$^\circ\text{C}$
$F_C$	Mounting force	30..120/7.5...2.7	N/lb
<b>Weight</b>		10	g

PLUS264™ (IXFB)

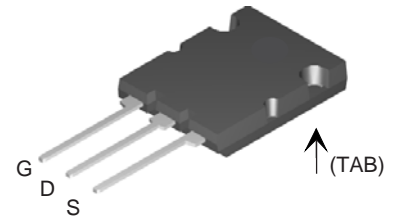

G = Gate      D = Drain  
 S = Source      TAB = Drain

### Features

- International standard packages
- Fast recovery diode
- Unclamped Inductive Switching (UIS) rated
- Low package inductance
  - easy to drive and to protect

### Advantages

- Plus 264™ package for clip or spring
- Space savings
- High power density

Symbol	Test Conditions	Characteristic Values		
		Min.	Typ.	Max.
$BV_{DSS}$	$V_{GS} = 0 \text{ V}$ , $I_D = 3 \text{ mA}$	600		V
$V_{GS(th)}$	$V_{DS} = V_{GS}$ , $I_D = 8 \text{ mA}$	3.0		5.0 V
$I_{GSS}$	$V_{GS} = \pm 30 \text{ V}_{DC}$ , $V_{DS} = 0$			$\pm 200 \text{ nA}$
$I_{DSS}$	$V_{DS} = V_{DSS}$ $V_{GS} = 0 \text{ V}$ $T_J = 125^\circ\text{C}$			25 $\mu\text{A}$ 2000 $\mu\text{A}$
$R_{DS(on)}$	$V_{GS} = 10 \text{ V}$ , $I_D = 0.5 I_{D25}$ , Note 1			75 $\text{m}\Omega$

Symbol	Test Conditions	Characteristic Values ( $T_J = 25^\circ\text{C}$ , unless otherwise specified)		
		Min.	Typ.	Max.
$g_{fs}$	$V_{DS} = 20\text{ V}; I_D = 0.5 I_{D25}$ , Note 1	50	80	S
$C_{iss}$	$V_{GS} = 0\text{ V}, V_{DS} = 25\text{ V}, f = 1\text{ MHz}$		23	nF
$C_{oss}$			1490	pF
$C_{rss}$			200	pF
$t_{d(on)}$	$V_{GS} = 10\text{ V}, V_{DS} = 0.5 V_{DSS}, I_D = 0.5 I_{D25}$ $R_G = 1\ \Omega$ (External)		28	ns
$t_r$			23	ns
$t_{d(off)}$			79	ns
$t_f$			24	ns
$Q_{g(on)}$	$V_{GS} = 10\text{ V}, V_{DS} = 0.5 V_{DSS}, I_D = 0.5 I_{D25}$		240	nC
$Q_{gs}$			96	nC
$Q_{gd}$			67	nC
$R_{thJC}$			0.10	$^\circ\text{C/W}$
$R_{thCS}$		0.13		$^\circ\text{C/W}$

**Source-Drain Diode**

Symbol	Test Conditions	Characteristic Values ( $T_J = 25^\circ\text{C}$ , unless otherwise specified)		
		Min.	Typ.	Max.
$I_S$	$V_{GS} = 0\text{ V}$			82 A
$I_{SM}$	Repetitive			200 A
$V_{SD}$	$I_F = I_S, V_{GS} = 0\text{ V}$ , Note 1			1.5 V
$t_{rr}$	$I_F = 25\text{ A}, -di/dt = 100\text{ A}/\mu\text{s}$ $V_R = 100\text{ V}$			200 ns
$Q_{RM}$			0.6	$\mu\text{C}$
$I_{RM}$			6.0	A

**Notes:**

1. Pulse test,  $t \leq 300\ \mu\text{s}$ , duty cycle  $d \leq 2\%$

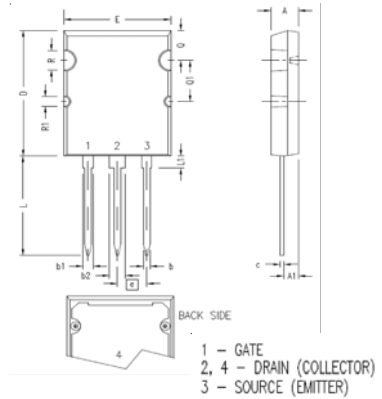
**PLUS264™ (IXFB) Outline**

SYM	INCHES		MILLIMETERS	
	MIN	MAX	MIN	MAX
A	.185	.209	4.70	5.31
A1	.102	.118	2.59	3.00
b	.037	.055	0.94	1.40
b1	.087	.102	2.21	2.59
b2	.110	.126	2.79	3.20
c	.017	.029	0.43	0.74
D	1.007	1.047	25.58	26.59
E	.760	.799	19.30	20.29
e	.215 BSC		5.46 BSC	
L	.779	.842	19.79	21.39
L1	.087	.102	2.21	2.59
Q	.240	.256	6.10	6.50
Q1	.330	.346	8.38	8.79
$\varnothing R$	.155	.187	3.94	4.75
$\varnothing R1$	.085	.093	2.16	2.36

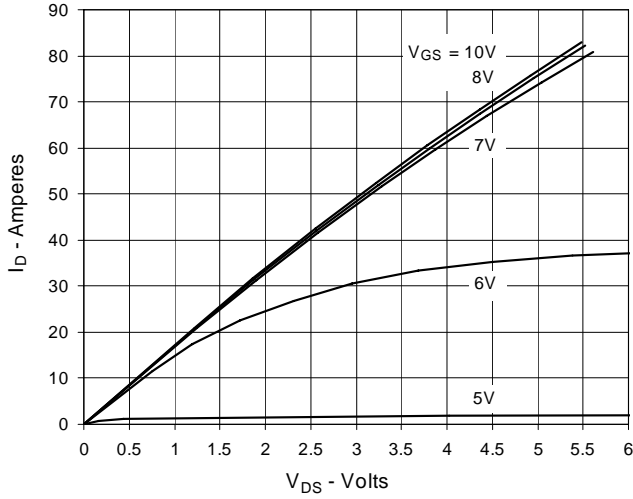
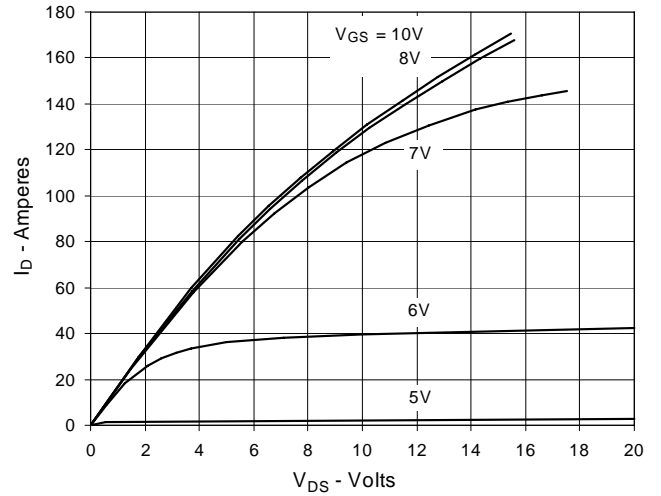
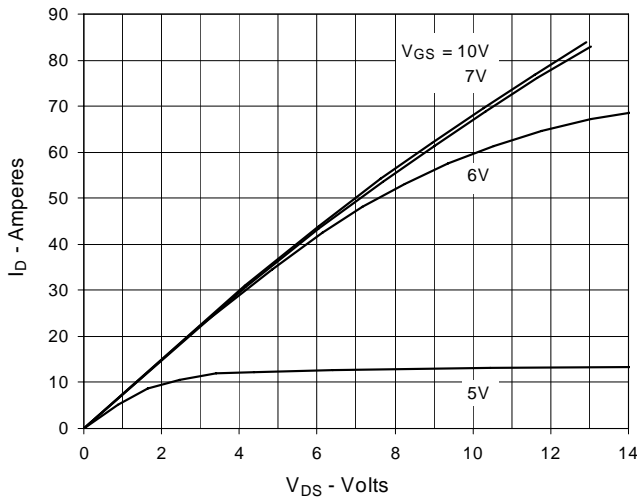
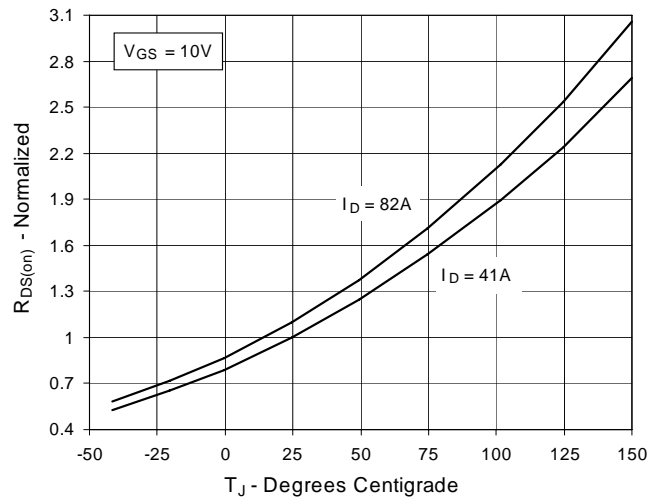
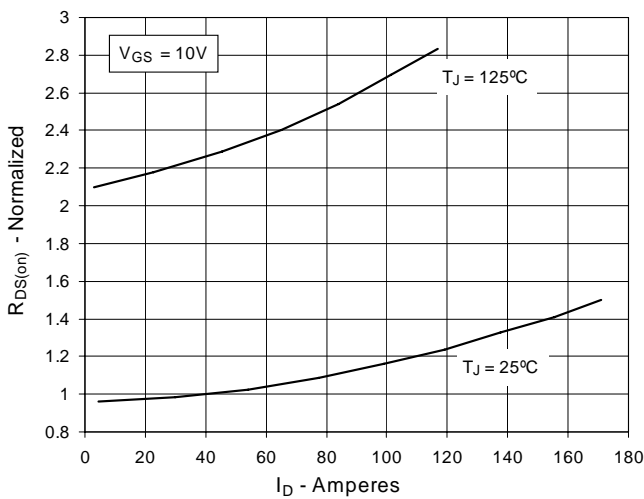
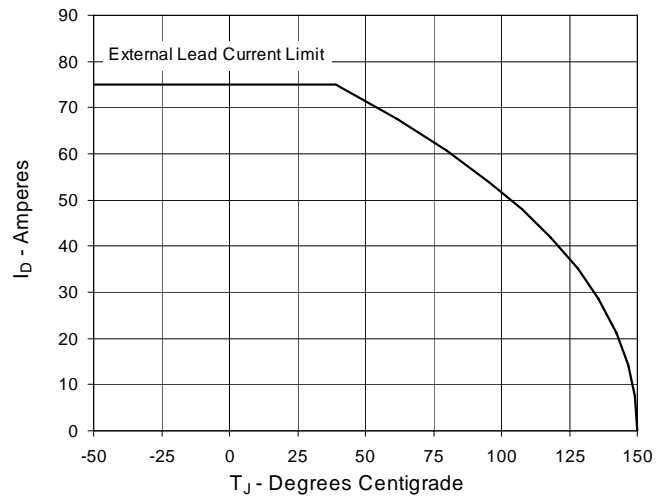
**Fig. 1. Output Characteristics  
@ 25°C**

**Fig. 2. Extended Output Characteristics  
@ 25°C**

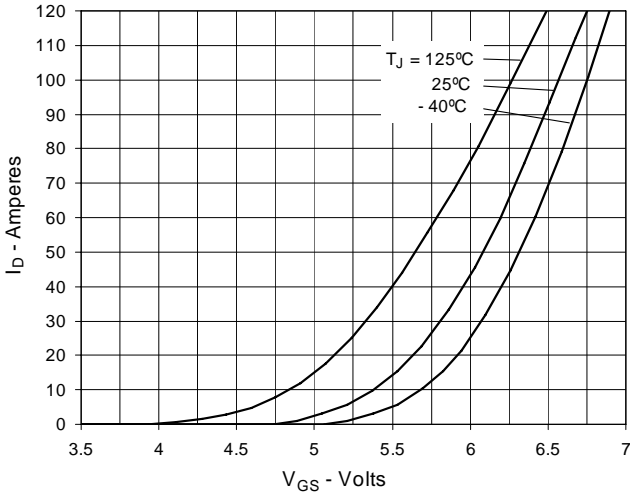
**Fig. 3. Output Characteristics  
@ 125°C**

**Fig. 4.  $R_{DS(on)}$  Normalized to  $I_D = 41A$  Value  
vs. Junction Temperature**

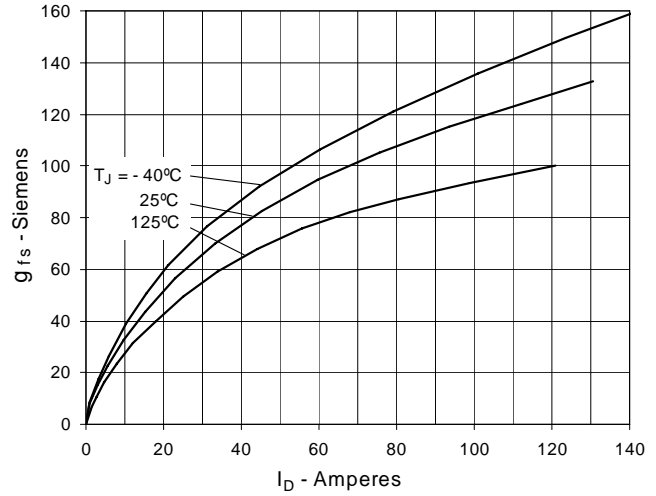
**Fig. 5.  $R_{DS(on)}$  Normalized to  $I_D = 41A$  Value  
vs. Drain Current**

**Fig. 6. Maximum Drain Current vs.  
Case Temperature**

**Fig. 7. Input Admittance**



**Fig. 8. Transconductance**



**Fig. 9. Forward Voltage Drop of Intrinsic Diode**

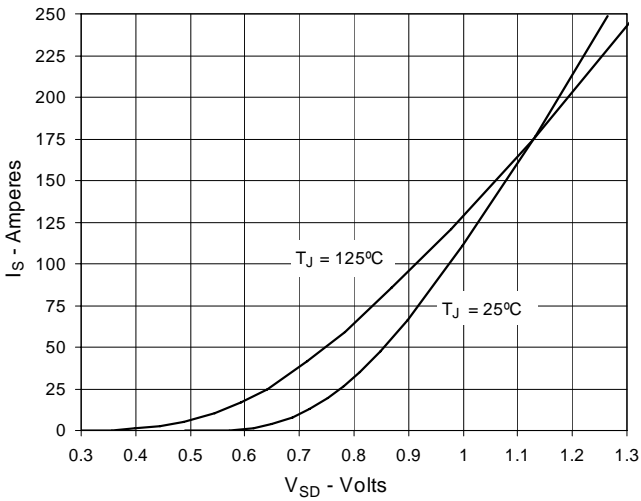

**Fig. 10. Gate Charge**

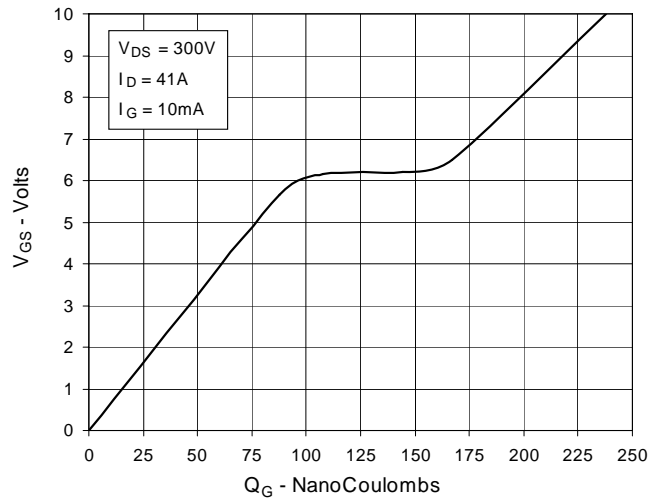

**Fig. 11. Capacitance**

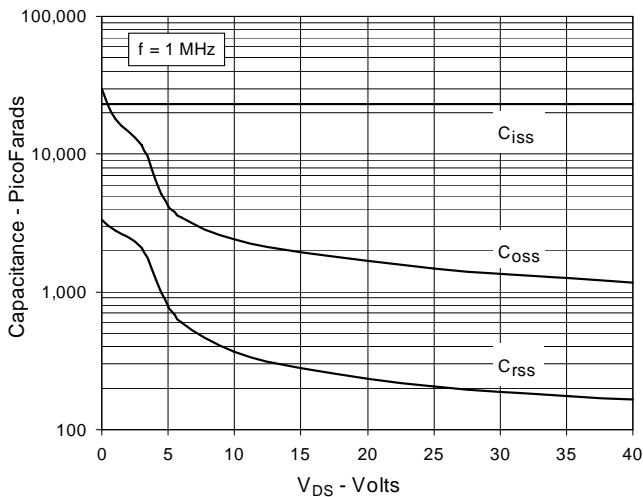

**Fig. 12. Forward-Bias Safe Operating Area**

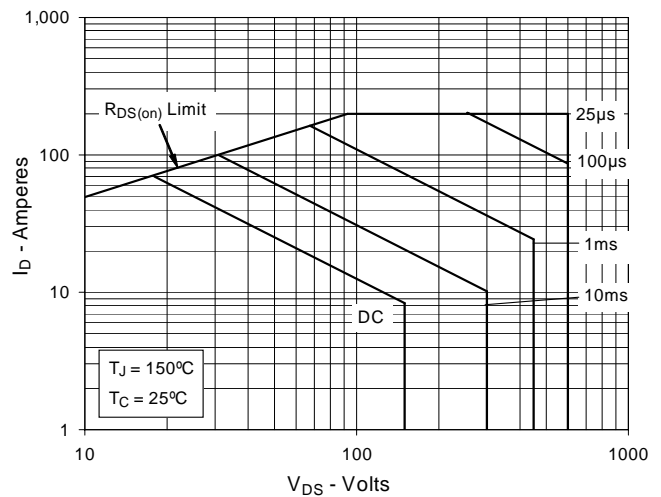

Fig. 13. Maximum Transient Thermal Resistance

