

PolarHV™ HiPerFET IXFC 110N10P

Power MOSFET

ISOPLUS220™

(Electrically Isolated Back Surface)

N-Channel Enhancement Mode
Fast Intrinsic Diode
Avalanche Rated

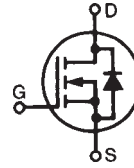

$$V_{DSS} = 100 \text{ V}$$

$$I_{D25} = 60 \text{ A}$$

$$R_{DS(on)} \leq 17 \text{ m}\Omega$$

$$t_{rr} \leq 150 \text{ ns}$$

Symbol	Test Conditions	Maximum Ratings	
V_{DSS}	$T_J = 25^\circ\text{C}$ to 175°C	100	V
V_{DGR}	$T_J = 25^\circ\text{C}$ to 175°C ; $R_{GS} = 1 \text{ M}\Omega$	100	V
V_{GSS}	Continuous	± 20	V
V_{GSM}	Transient	± 30	V
I_{D25}	$T_C = 25^\circ\text{C}$	60	A
I_{DM}	$T_C = 25^\circ\text{C}$, pulse width limited by T_{JM}	250	A
I_{AR}	$T_C = 25^\circ\text{C}$	60	A
E_{AR}	$T_C = 25^\circ\text{C}$	40	mJ
E_{AS}	$T_C = 25^\circ\text{C}$	1.0	J
dv/dt	$I_S \leq I_{DM}$, $di/dt \leq 100 \text{ A}/\mu\text{s}$, $V_{DD} \leq V_{DSS}$, $T_J \leq 150^\circ\text{C}$, $R_G = 4 \Omega$	10	V/ns
P_D	$T_C = 25^\circ\text{C}$	120	W
T_J		-55 ... +175	$^\circ\text{C}$
T_{JM}		175	$^\circ\text{C}$
T_{stg}		-55 ... +150	$^\circ\text{C}$
T_L	1.6 mm (0.062 in.) from case for 10 s	300	$^\circ\text{C}$
T_{SOLD}	Plastic body for 10 s	260	$^\circ\text{C}$
V_{ISOL}	50/60 Hz, RMS $t = 1$ minute leads-to-tab	2500	V~
F_C	Mounting Force	11..65 / 2.5..15	N/lb
Weight		2	g

ISOPLUS220™ (IXFC)

E153432

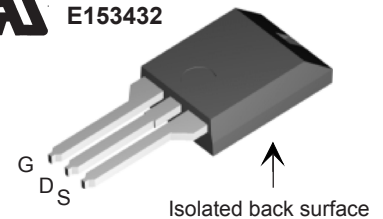

G = Gate
S = Source
D = Drain

Features

- † Silicon chip on Direct-Copper-Bond substrate
- High power dissipation
- Isolated mounting surface
- 2500V electrical isolation
- † Low drain to tab capacitance (<35pF)
- † Low $R_{DS(on)}$ HDMOS™ process
- † Rugged polysilicon gate cell structure
- † Unclamped Inductive Switching (UIS) rated
- † Fast intrinsic Rectifier

Applications

- † DC-DC converters
- † Battery chargers
- † Switched-mode and resonant-mode power supplies
- † DC choppers
- † AC motor control

Advantages

- † Easy assembly: no screws, or isolation foils required
- † Space savings
- † High power density
- † Low collector capacitance to ground (low EMI)

Symbol	Test Conditions ($T_J = 25^\circ\text{C}$, unless otherwise specified)	Characteristic Values		
		Min.	Typ.	Max.
BV_{DSS}	$V_{GS} = 0 \text{ V}$, $I_D = 250 \mu\text{A}$	100		V
$V_{GS(th)}$	$V_{DS} = V_{GS}$, $I_D = 4 \text{ mA}$	2.5		5.0 V
I_{GSS}	$V_{GS} = \pm 20 \text{ V}_{DC}$, $V_{DS} = 0$			$\pm 100 \text{ nA}$
I_{DSS}	$V_{DS} = V_{DSS}$ $V_{GS} = 0 \text{ V}$ $T_J = 150^\circ\text{C}$			25 μA 250 μA
$R_{DS(on)}$	$V_{GS} = 10 \text{ V}$, $I_D = 55 \text{ A}$			17 $\text{m}\Omega$

Symbol	Test Conditions	Characteristic Values ($T_J = 25^\circ\text{C}$, unless otherwise specified)		
		Min.	Typ.	Max.
g_{fs}	$V_{DS} = 10\text{ V}$; $I_D = 55\text{ A}$, Note 1	30	43	S
C_{iss}	$V_{GS} = 0\text{ V}$, $V_{DS} = 25\text{ V}$, $f = 1\text{ MHz}$		3550	pF
C_{oss}			1370	pF
C_{rss}			440	pF
$t_{d(on)}$	$V_{GS} = 10\text{ V}$, $V_{DS} = 0.5 V_{DSS}$, $I_D = 60\text{ A}$ $R_G = 4\ \Omega$ (External)		21	ns
t_r			25	ns
$t_{d(off)}$			65	ns
t_f			25	ns
$Q_{g(on)}$	$V_{GS} = 10\text{ V}$, $V_{DS} = 0.5 V_{DSS}$, $I_D = 55\text{ A}$		110	nC
Q_{gs}			25	nC
Q_{gd}			62	nC
R_{thJC}				1.25°C/W
R_{thCS}		0.21		$^\circ\text{C/W}$

Symbol	Test Conditions	Characteristic Values ($T_J = 25^\circ\text{C}$, unless otherwise specified)		
		Min.	Typ.	Max.
I_s	$V_{GS} = 0\text{ V}$			110 A
I_{SM}	Repetitive			250 A
V_{SD}	$I_F = I_s$, $V_{GS} = 0\text{ V}$, Pulse test, $t \leq 300\ \mu\text{s}$, duty cycle $d \leq 2\%$			1.5 V
t_{rr}	$I_F = 25\text{ A}$, $-di/dt = 100\text{ A}/\mu\text{s}$ $V_R = 50\text{ V}$, $V_{GS} = 0\text{ V}$			150 ns
Q_{RM}		0.6		μC

Note: Pulse test, $t \leq 300\ \mu\text{s}$, duty cycle $d \leq 2\%$

ISOPLUS220™ (IXFC) Outline

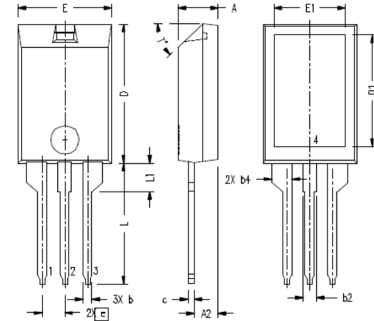

Note:
Bottom heatsink (Pin 4) is electrically isolated from Pin 1, 2, or 3.

SYM	INCHES		MILLIMETERS	
	MIN	MAX	MIN	MAX
A	.157	.197	4.00	5.00
A2	.098	.118	2.50	3.00
b	.035	.051	0.90	1.30
b2	.049	.065	1.25	1.65
b4	.093	.100	2.35	2.55
c	.028	.039	0.70	1.00
D	.591	.630	15.00	16.00
D1	.472	.512	12.00	13.00
E	.394	.433	10.00	11.00
E1	.295	.335	7.50	8.50
e	.100 BASIC		2.55 BASIC	
L	.512	.571	13.00	14.50
L1	.118	.138	3.00	3.50
T*			42.5°	47.5°

Ref. IXYS CO 0177 R0

Fig. 1. Output Characteristics @ 25°C

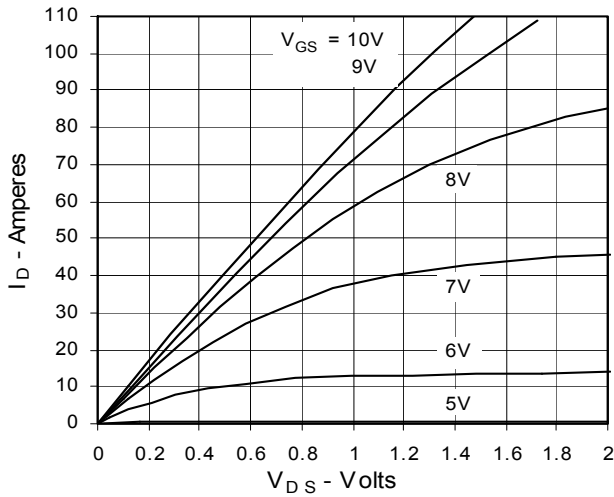

Fig. 2. Extended Output Characteristics @ 25°C

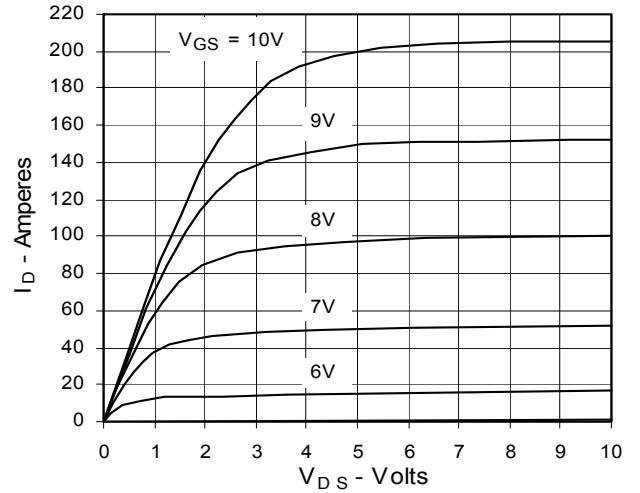

Fig. 3. Output Characteristics @ 150°C

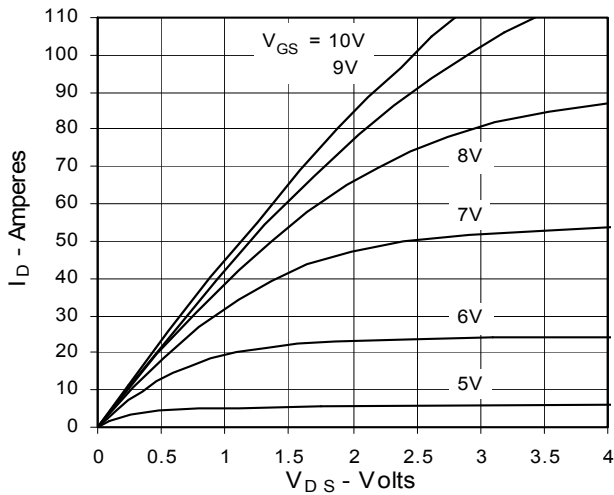

Fig. 4. $R_{DS(on)}$ Normalized to $I_D = 55A$ Value vs. Junction Temperature

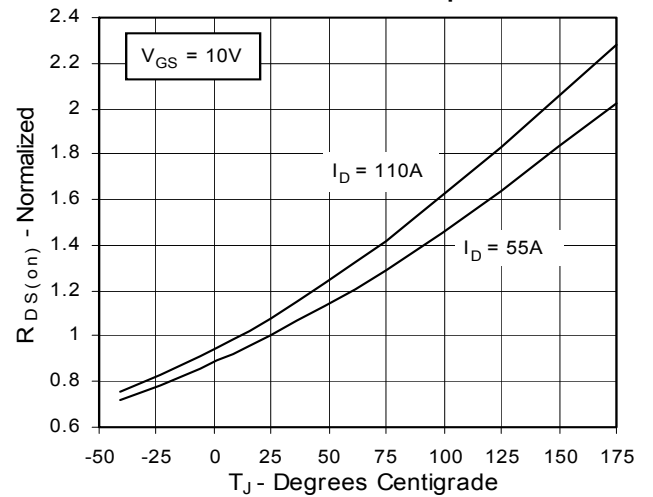

Fig. 5. $R_{DS(on)}$ Normalized to $I_D = 55A$ Value vs. Drain Current

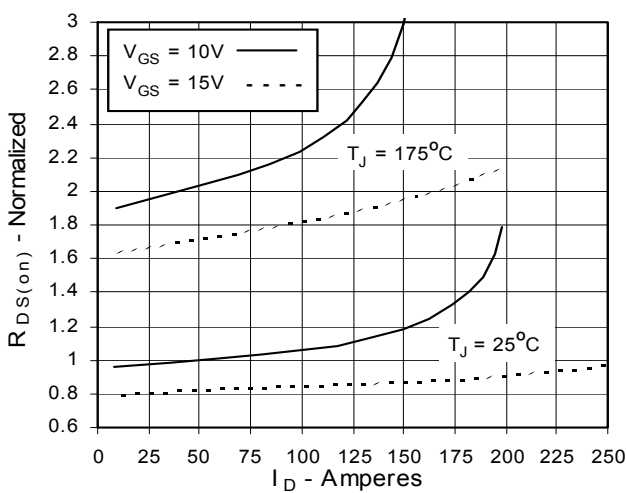

Fig. 6. Drain Current vs. Case Temperature

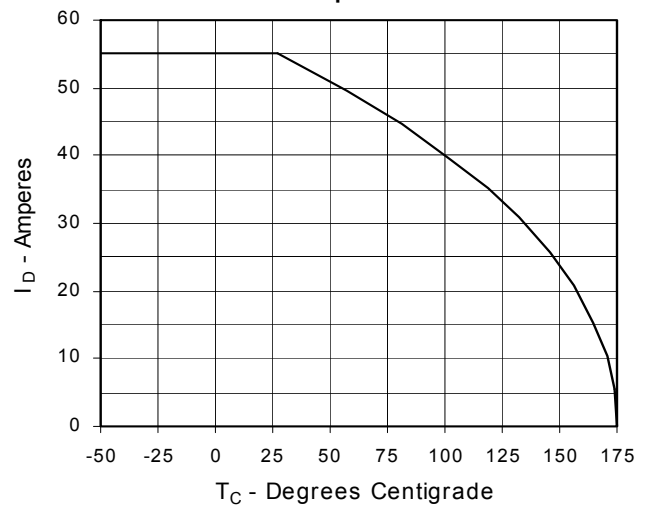

Fig. 7. Input Admittance

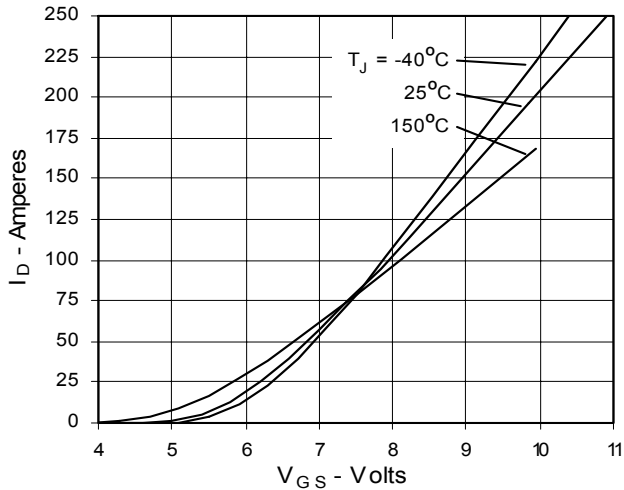

Fig. 8. Transconductance

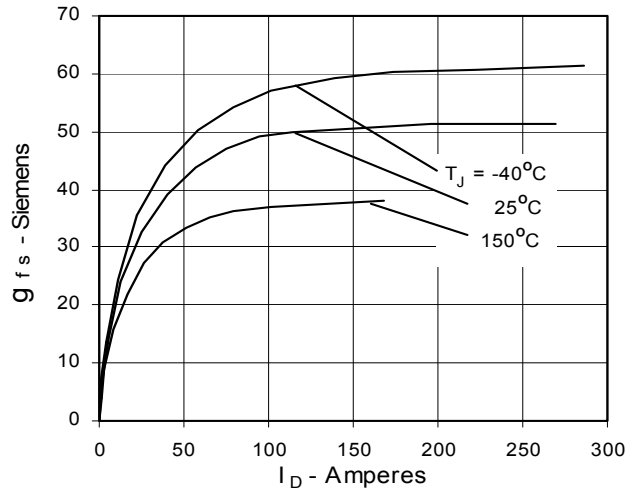

Fig. 9. Source Current vs. Source-To-Drain Voltage

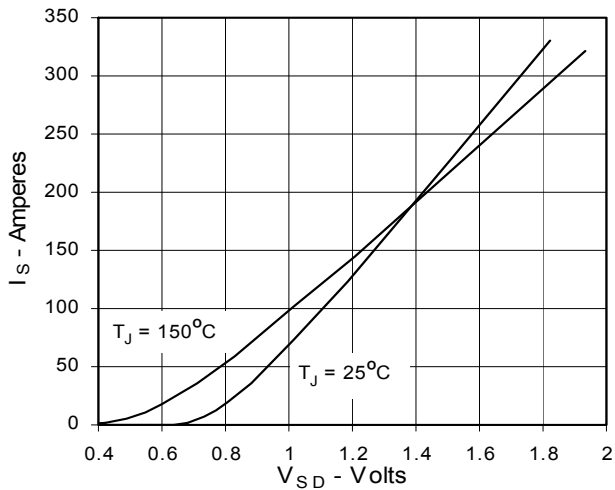

Fig. 10. Gate Charge

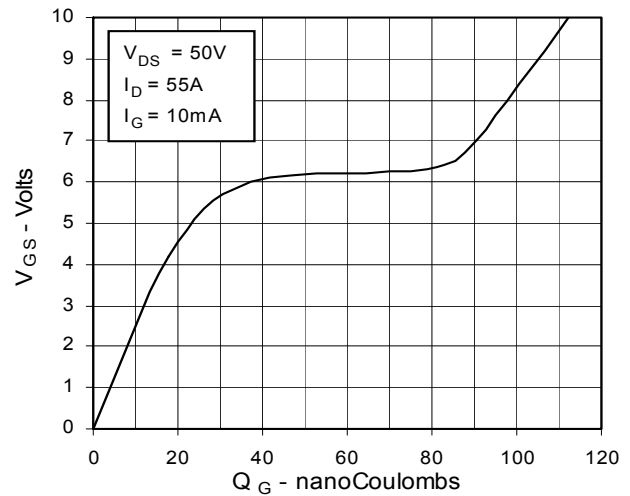

Fig. 11. Capacitance

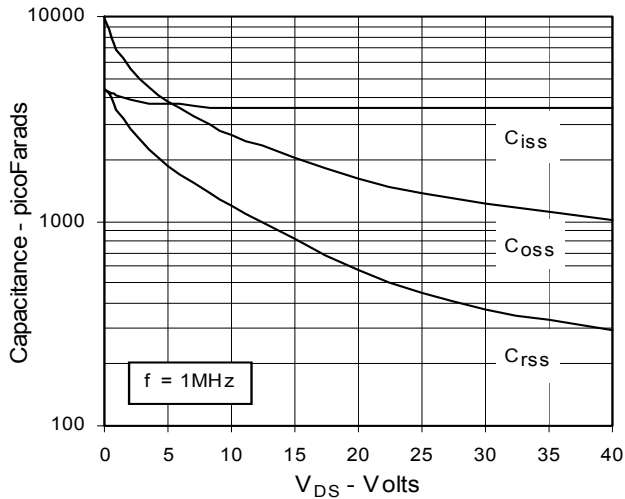

Fig. 12. Forward-Bias Safe Operating Area

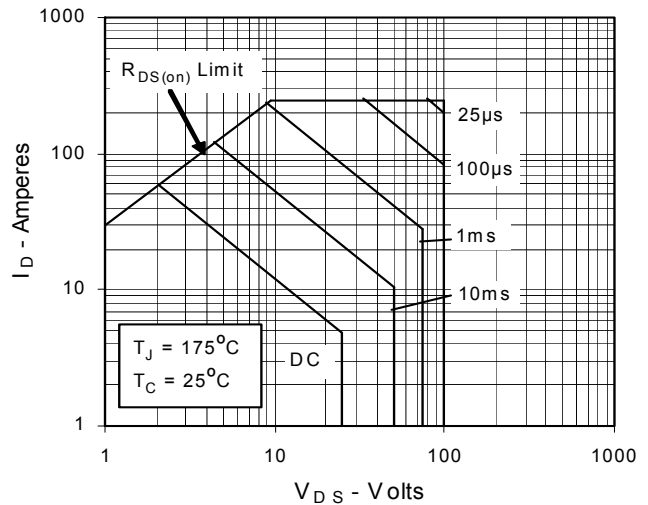

Fig. 13. Maximum Transient Thermal Resistance

