

# HiPerFET™ Power MOSFETs Q-Class

IXFE 44N50Q  
IXFE 48N50Q

$V_{DSS}$	$I_{D25}$	$R_{DS(on)}$
500 V	39 A	120 mΩ
500 V	41 A	110 mΩ

$t_{rr} \leq 250$  ns

N-Channel Enhancement Mode  
Avalanche Rated, Low  $Q_g$ , High  $dv/dt$

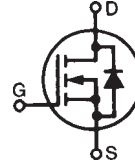

## Preliminary data sheet

ISOPLUS 227™ (IXFE)

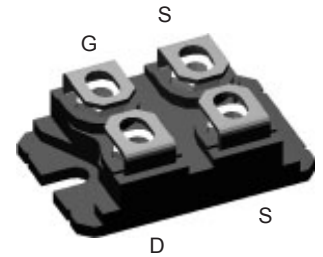

G = Gate                      D = Drain  
S = Source

Either Source terminal at miniBLOC can be used as Main or Kelvin Source

Symbol	Test Conditions	Maximum Ratings	
$V_{DSS}$	$T_J = 25^\circ\text{C}$ to $150^\circ\text{C}$	500	V
$V_{DGR}$	$T_J = 25^\circ\text{C}$ to $150^\circ\text{C}$ ; $R_{GS} = 1\text{ M}\Omega$	500	V
$V_{GS}$	Continuous	$\pm 20$	V
$V_{GSM}$	Transient	$\pm 30$	V
$I_{D25}$	$T_C = 25^\circ\text{C}$	44N50Q 39 48N50Q 41	A
$I_{DM}$	$T_C = 25^\circ\text{C}$ , pulse width limited by $T_{JM}$	44N50Q 176 48N50Q 192	A
$I_{AR}$	$T_C = 25^\circ\text{C}$	48	A
$E_{AR}$ $E_{AS}$	$T_C = 25^\circ\text{C}$	60 2.5	mJ mJ
$dv/dt$	$I_S \leq I_{DM}$ , $di/dt \leq 100\text{ A}/\mu\text{s}$ , $V_{DD} \leq V_{DSS}$ , $T_J \leq 150^\circ\text{C}$ , $R_G = 2\ \Omega$	15	V/ns
$P_D$	$T_C = 25^\circ\text{C}$	400	W
$T_J$		-40 to +150	$^\circ\text{C}$
$T_{JM}$		150	$^\circ\text{C}$
$T_{stg}$		-40 to +150	$^\circ\text{C}$
$V_{ISOL}$	50/60 Hz, RMS $t = 1$ min $I_{ISOL} \leq 1\text{ mA}$ $t = 1$ s	2500 3000	V~ V~
$M_d$	Mounting torque Terminal connection torque	1.5/13 1.5/13	Nm/lb.in. Nm/lb.in.
<b>Weight</b>		19	g

## Features

- Conforms to SOT-227B outline
- Low  $R_{DS(on)}$  HDMOS™ process
- Rugged polysilicon gate cell structure
- Unclamped Inductive Switching (UIS) rated
- Low package inductance
- Fast intrinsic Rectifier

## Applications

- DC-DC converters
- Battery chargers
- Switched-mode and resonant-mode power supplies
- DC choppers
- Temperature and lighting controls

## Advantages

- Low cost
- Easy to mount
- Space savings
- High power density

Symbol	Test Conditions	Characteristic Values ( $T_J = 25^\circ\text{C}$ , unless otherwise specified)		
		min.	typ.	max.
$V_{DSS}$	$V_{GS} = 0\text{ V}$ , $I_D = 1\text{ mA}$	500		V
$V_{GS(th)}$	$V_{DS} = V_{GS}$ , $I_D = 4\text{ mA}$	2.0		V
$I_{GSS}$	$V_{GS} = \pm 20\text{ V}_{DC}$ , $V_{DS} = 0$			$\pm 100$ nA
$I_{DSS}$	$V_{DS} = V_{DSS}$ , $V_{GS} = 0\text{ V}$		$T_J = 25^\circ\text{C}$ $T_J = 125^\circ\text{C}$	100 $\mu\text{A}$ 2 mA
$R_{DS(on)}$	$V_{GS} = 10\text{ V}$ , $I_D = I_T$		44N50Q 48N50Q	120 mΩ 110 mΩ
	Notes 1, 2			

Symbol	Test Conditions	Characteristic Values ( $T_J = 25^\circ\text{C}$ , unless otherwise specified)		
		min.	typ.	max.
$g_{fs}$	$V_{DS} = 20\text{ V}; I_D = I_T$ , Notes 1, 2	30	42	S
$C_{iss}$	$V_{GS} = 0\text{ V}, V_{DS} = 25\text{ V}, f = 1\text{ MHz}$		7000	pF
$C_{oss}$			960	pF
$C_{rss}$			230	pF
$t_{d(on)}$	$V_{GS} = 10\text{ V}, V_{DS} = 0.5 \cdot V_{DSS}, I_D = I_T$ $R_G = 4.7\ \Omega$ (External),		33	ns
$t_r$			22	ns
$t_{d(off)}$			75	ns
$t_f$			10	ns
$Q_{g(on)}$	$V_{GS} = 10\text{ V}, V_{DS} = 0.5 \cdot V_{DSS}, I_D = I_T$		190	nC
$Q_{gs}$			40	nC
$Q_{gd}$			86	nC
$R_{thJC}$			0.31	K/W
$R_{thCK}$			0.07	K/W

Symbol	Test Conditions	Characteristic Values ( $T_J = 25^\circ\text{C}$ , unless otherwise specified)		
		min.	typ.	max.
$I_s$	$V_{GS} = 0\text{ V}$			48 A
$I_{SM}$	Repetitive; pulse width limited by $T_{JM}$			192 A
$V_{SD}$	$I_F = I_S, V_{GS} = 0\text{ V}$ , Note:1			1.5 V
$t_{rr}$	$I_F = 25\text{ A}, -di/dt = 100\text{ A}/\mu\text{s}, V_R = 100\text{ V}$		1.0	250 ns
$Q_{RM}$			10	$\mu\text{C}$
$I_{RM}$				A

### ISOPLUS-227 B

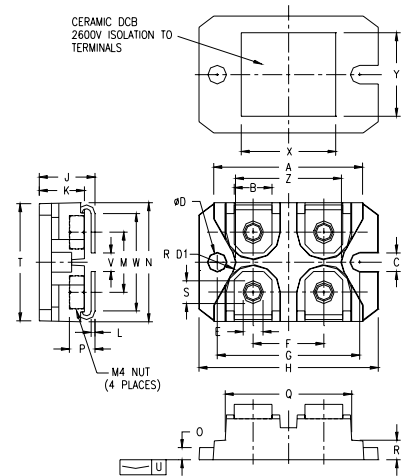

SYM	INCHES		MILLIMETERS	
	MIN	MAX	MIN	MAX
A	1.240	1.270	31.50	32.26
B	.310	.330	7.87	8.38
C	.155	.165	3.94	4.19
D	.155	.165	3.94	4.19
D1	.150	.157	3.81	3.98
E	.160	.168	4.06	4.27
F	.587	.595	14.91	15.11
G	1.186	1.193	30.12	30.30
H	1.489	1.505	37.80	38.23
J	.465	.481	11.81	12.22
K	.370	.380	9.40	9.65
L	.030	.033	0.76	0.84
M	.496	.506	12.60	12.85
N	.990	1.001	25.15	25.42
O	.100	.105	2.54	2.67
P	.195	.235	4.95	5.97
Q	1.045	1.059	26.54	26.90
R	.160	.170	4.06	4.32
S	.186	.191	4.72	4.85
T	.968	.987	24.59	25.07
U	-.001	.002	-0.03	0.05
V	.130	.160	3.30	4.06
W	.780	.830	19.81	21.08
X	.770	.810	19.56	20.57
Y	.680	.720	17.27	18.29
Z	.885	.892	22.48	22.66

- Note: 1. Pulse test,  $t \leq 300\ \mu\text{s}$ , duty cycle  $d \leq 2\%$   
 2.  $I_T$  Test current:  
 44N50Q:  $I_T = 22\text{ A}$   
 48N50Q:  $I_T = 24\text{ A}$

IXYS reserves the right to change limits, test conditions, and dimensions.

**Fig. 1. Output Characteristics  
@ 25 Deg. C**

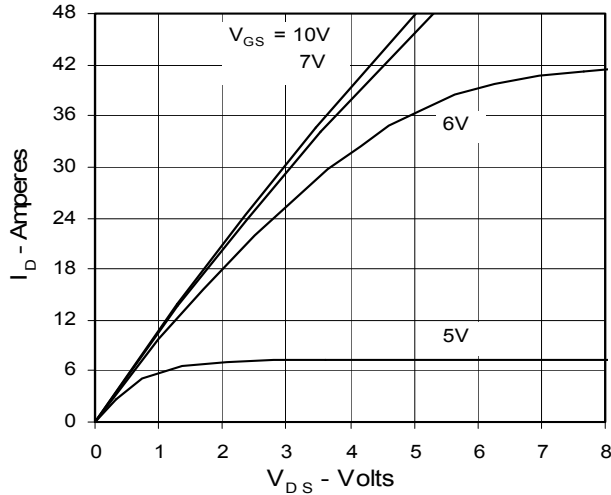

**Fig. 2. Extended Output Characteristics  
@ 25 deg. C**

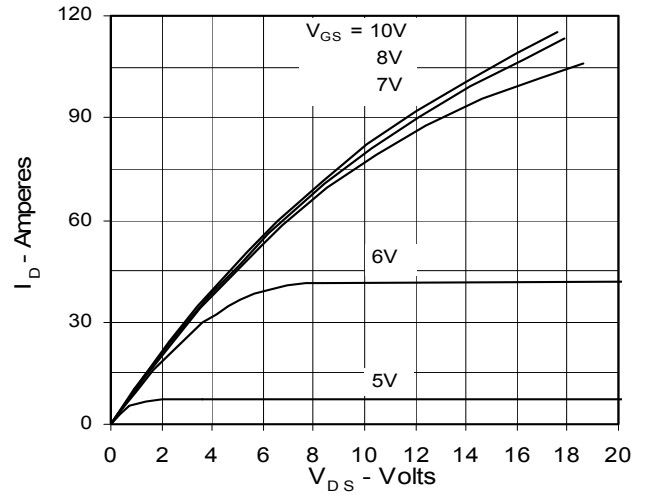

**Fig. 3. Output Characteristics  
@ 125 Deg. C**

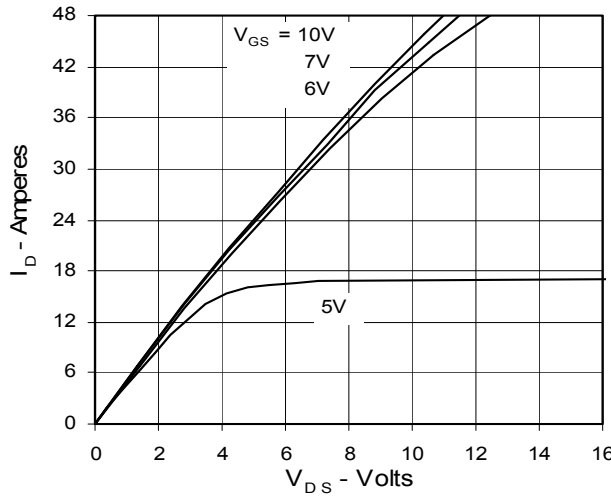

**Fig. 4.  $R_{DS(on)}$  Normalized to  $I_{D25}$  Value vs. Junction Temperature**

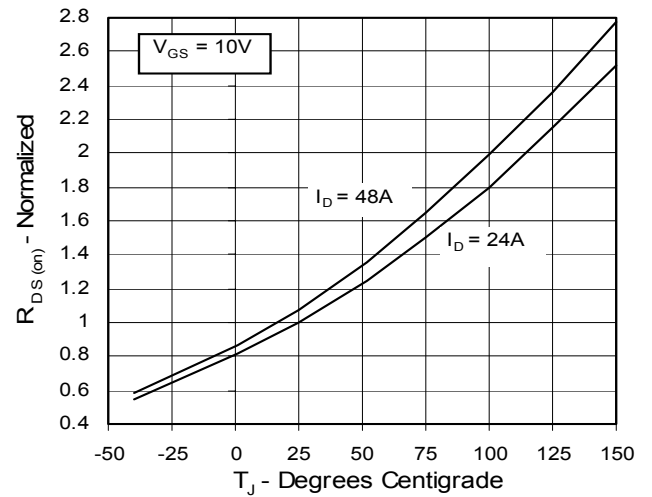

**Fig. 5.  $R_{DS(on)}$  Normalized to  $I_{D25}$  Value vs.  $I_D$**

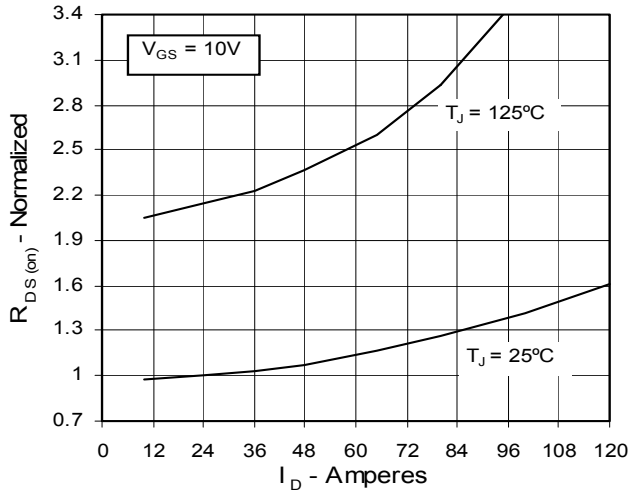

**Fig. 6. Drain Current vs. Case Temperature**

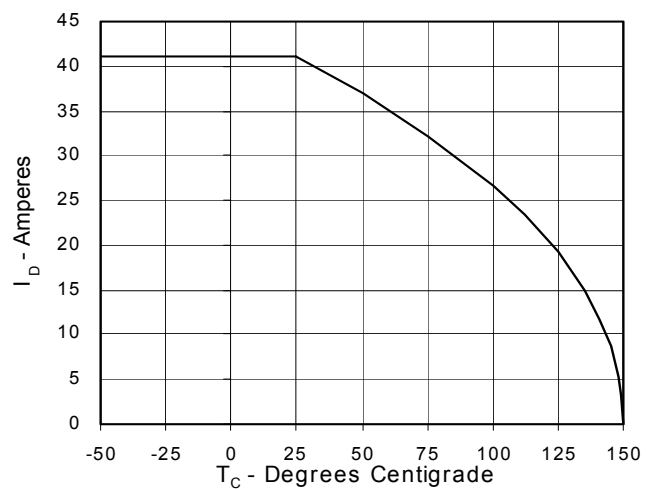

**Fig. 7. Input Admittance**

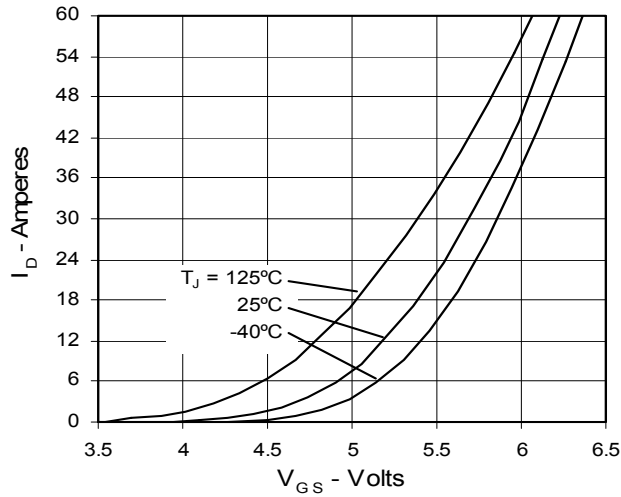

**Fig. 8. Transconductance**

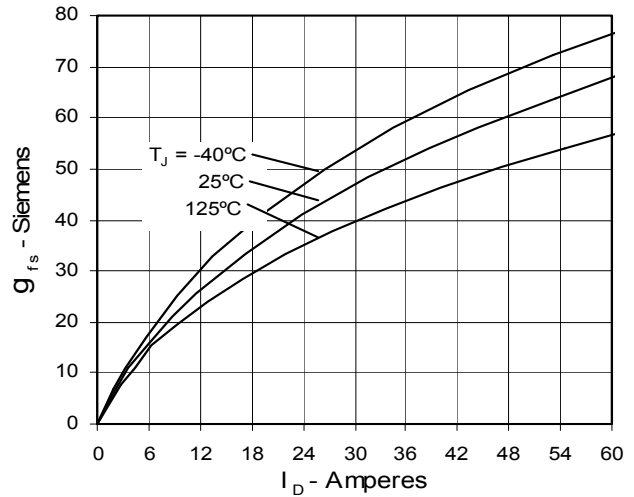

**Fig. 9. Source Current vs. Source-To-Drain Voltage**

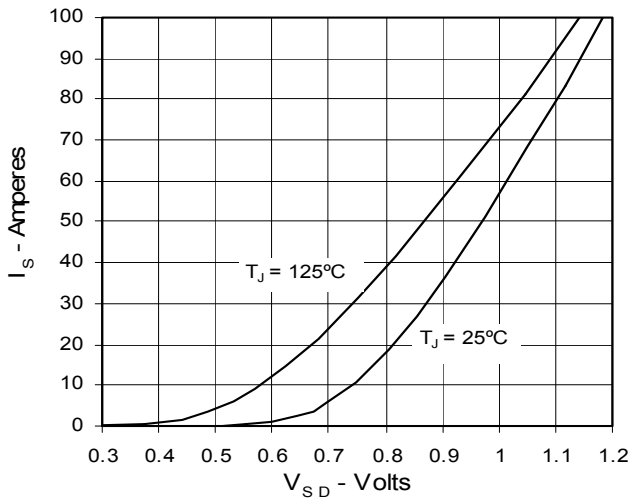

**Fig. 10. Gate Charge**

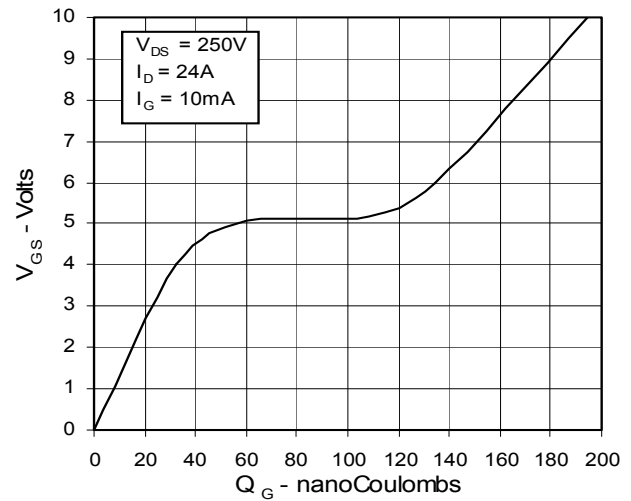

**Fig. 11. Capacitance**

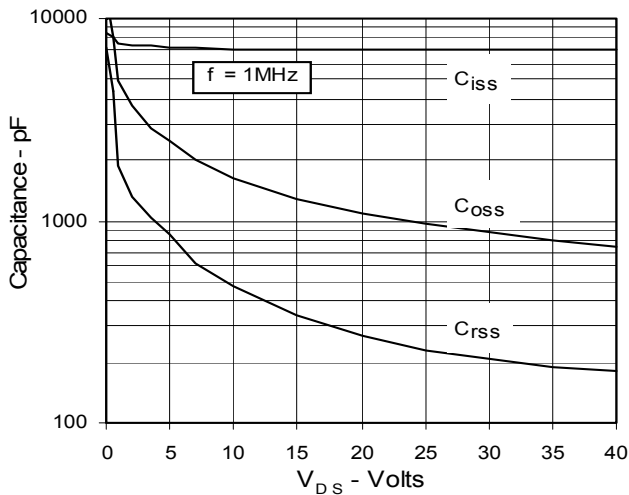

**Fig. 12. Maximum Transient Thermal Resistance**

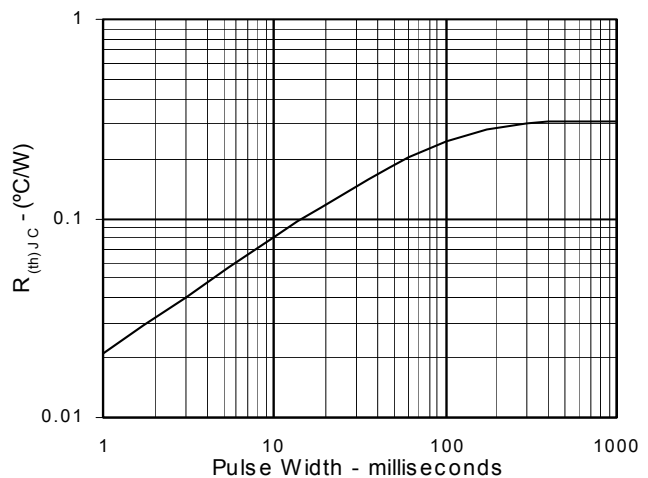

IXYS reserves the right to change limits, test conditions, and dimensions.

IXYS MOSFETs and IGBTs are covered by one or more of the following U.S. patents:

4,835,592 4,881,106 5,017,508 5,049,961 5,187,117 5,486,715 6,306,728B1 6,259,123B1 6,306,728B1  
4,850,072 4,931,844 5,034,796 5,063,307 5,237,481 5,381,025 6,404,065B1 6,162,665 6,534,343