

HiPerFET™

Power MOSFETs

Q Class

IXFH/IXFT12N100Q
IXFH/IXFT10N100Q

V_{DSS}	I_{D25}	$R_{DS(on)}$
1000 V	12 A	1.05 Ω
1000 V	10 A	1.20 Ω

$t_{rr} \leq 250$ ns

N-Channel Enhancement Mode
Avalanche Rated
Low Q_g , High dv/dt

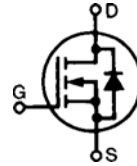

Symbol	Test Conditions	Maximum Ratings	
V_{DSS}	$T_J = 25^\circ\text{C}$ to 150°C	1000	V
V_{DGR}	$T_J = 25^\circ\text{C}$ to 150°C ; $R_{GS} = 1\text{ M}\Omega$	1000	V
V_{GS}	Continuous	± 20	V
V_{GSM}	Transient	± 30	V
I_{D25}	$T_C = 25^\circ\text{C}$	12N100Q: 12 10N100Q: 10	A
I_{DM}	$T_C = 25^\circ\text{C}$, pulse width limited by T_{JM}	12N100Q: 48 10N100Q: 40	A
I_{AR}	$T_C = 25^\circ\text{C}$	12N100Q: 12 10N100Q: 10	A
E_{AR}	$T_C = 25^\circ\text{C}$	30	mJ
dv/dt	$I_S \leq I_{DM}$, $di/dt \leq 100\text{ A}/\mu\text{s}$, $V_{DD} \leq V_{DSS}$, $T_J \leq 150^\circ\text{C}$, $R_G = 2\ \Omega$	5	V/ns
P_D	$T_C = 25^\circ\text{C}$	300	W
T_J		-55 ... +150	$^\circ\text{C}$
T_{JM}		150	$^\circ\text{C}$
T_{stg}		-55 ... +150	$^\circ\text{C}$
T_L	1.6 mm (0.063 in) from case for 10 s	300	$^\circ\text{C}$
M_d	Mounting torque	1.13/10	Nm/lb.in.
Weight		TO-247 AD: 6 TO-268: 4	g

TO-247 AD (IXFH)

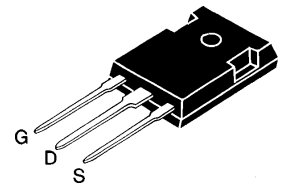

TO-268 (D3) (IXFT)

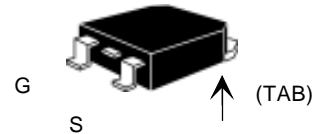

G = Gate D = Drain
S = Source TAB = Drain

Symbol	Test Conditions	Characteristic Values ($T_J = 25^\circ\text{C}$, unless otherwise specified)		
		min.	typ.	max.
V_{DSS}	$V_{GS} = 0\text{ V}$, $I_D = 3\text{ mA}$	1000		V
$V_{GS(th)}$	$V_{DS} = V_{GS}$, $I_D = 4\text{ mA}$	2.5		5.5 V
I_{GSS}	$V_{GS} = \pm 20\text{ V}_{DC}$, $V_{DS} = 0$			± 100 nA
I_{DSS}	$V_{DS} = 0.8 \cdot V_{DSS}$, $T_J = 25^\circ\text{C}$ $V_{GS} = 0\text{ V}$, $T_J = 125^\circ\text{C}$			50 μA 1 mA
$R_{DS(on)}$	$V_{GS} = 10\text{ V}$, $I_D = 0.5 I_{D25}$ Pulse test, $t \leq 300\ \mu\text{s}$, duty cycle $d \leq 2\%$	12N100Q: 1.05 10N100Q: 1.20		Ω

Features

- IXYS advanced low Q_g process
- Low gate charge and capacitances
 - easier to drive
 - faster switching
- International standard packages
- Low $R_{DS(on)}$
- Unclamped Inductive Switching (UIS) rated
- Molding epoxies meet UL 94 V-0 flammability classification

Advantages

- Easy to mount
- Space savings
- High power density

Symbol	Test Conditions	Characteristic Values		
		(T _J = 25°C, unless otherwise specified)		
		min.	typ.	max.
g_{fs}	V _{DS} = 15 V; I _D = 0.5 • I _{D25} , pulse test	4	10	S
C_{iss}	V _{GS} = 0 V, V _{DS} = 25 V, f = 1 MHz		2900	pF
C_{oss}			315	pF
C_{rss}			50	pF
t_{d(on)}	V _{GS} = 10 V, V _{DS} = 0.5 • V _{DSS} , I _D = 0.5 • I _{D25} R _G = 2 Ω (External),		20	ns
t_r			23	ns
t_{d(off)}			40	ns
t_f			15	ns
Q_{g(on)}	V _{GS} = 10 V, V _{DS} = 0.5 • V _{DSS} , I _D = 0.5 • I _{D25}		90	nC
Q_{gs}			30	nC
Q_{gd}			40	nC
R_{thJC}	(TO-247)		0.42	K/W
R_{thCK}			0.25	K/W

Symbol	Test Conditions	Characteristic Values		
		(T _J = 25°C, unless otherwise specified)		
		min.	typ.	max.
I_S	V _{GS} = 0 V			12 A
I_{SM}	Repetitive; pulse width limited by T _{JM}			48 A
V_{SD}	I _F = I _S , V _{GS} = 0 V, Pulse test, t ≤ 300 μs, duty cycle d ≤ 2 %			1.5 V
t_{rr}	I _F = I _S , -di/dt = 100 A/μs, V _R = 100 V		200	ns
Q_{RM}			0.6	μC
I_{RM}			7	A

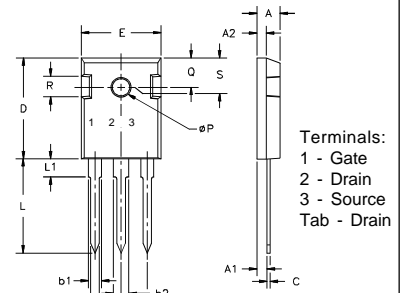
TO-247 AD (IXFH) Outline

Terminals:
 1 - Gate
 2 - Drain
 3 - Source
 Tab - Drain

Dim.	Millimeter		Inches	
	Min.	Max.	Min.	Max.
A	4.7	5.3	.185	.209
A ₁	2.2	2.54	.087	.102
A ₂	2.2	2.6	.087	.102
b	1.0	1.4	.040	.055
b ₁	1.65	2.13	.065	.084
b ₂	2.87	3.12	.113	.123
C	.4	.8	.016	.031
D	20.80	21.46	.819	.845
E	15.75	16.26	.610	.640
e	5.20	5.72	0.205	0.225
L	19.81	20.32	.780	.800
L1		4.50		.177
ØP	3.55	3.65	.140	.144
Q	5.89	6.40	0.232	0.252
R	4.32	5.49	.170	.216
S	6.15	BSC	.242	BSC

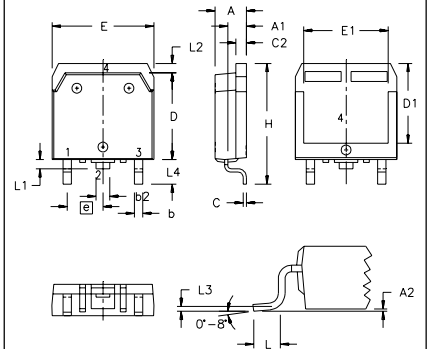
TO-268 Outline

SYM	INCHES		MILLIMETERS	
	MIN	MAX	MIN	MAX
A	.193	.201	4.90	5.10
A1	.106	.114	2.70	2.90
A2	.001	.010	0.02	0.25
b	.045	.057	1.15	1.45
b2	.075	.083	1.90	2.10
C	.016	.026	0.40	0.65
C2	.057	.063	1.45	1.60
D	54.3	55.1	13.80	14.00
D1	48.8	50.0	12.40	12.70
E	62.4	63.2	15.85	16.05
E1	52.4	53.5	13.30	13.60
e	.215	BSC	5.45	BSC
H	.736	.752	18.70	19.10
L	.094	.106	2.40	2.70
L1	.047	.055	1.20	1.40
L2	.039	.045	1.00	1.15
L3	.010	BSC	0.25	BSC
L4	.150	.161	3.80	4.10

IXYS reserves the right to change limits, test conditions, and dimensions.

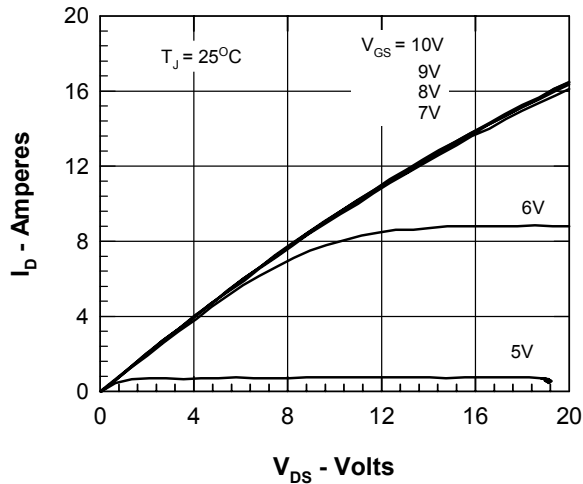

Figure 1. Output Characteristics at 25°C

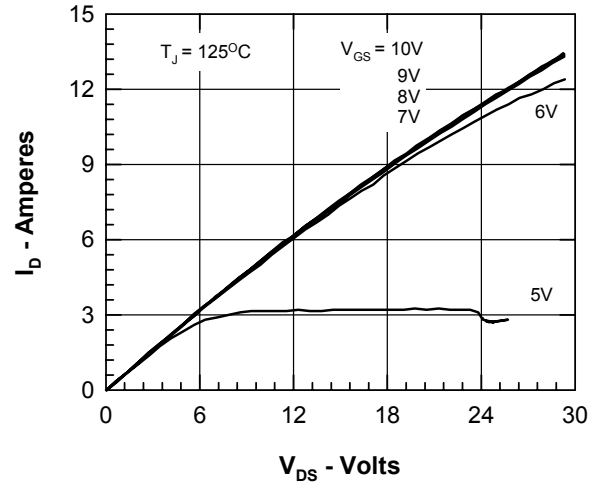

Figure 2. Output Characteristics at 125°C

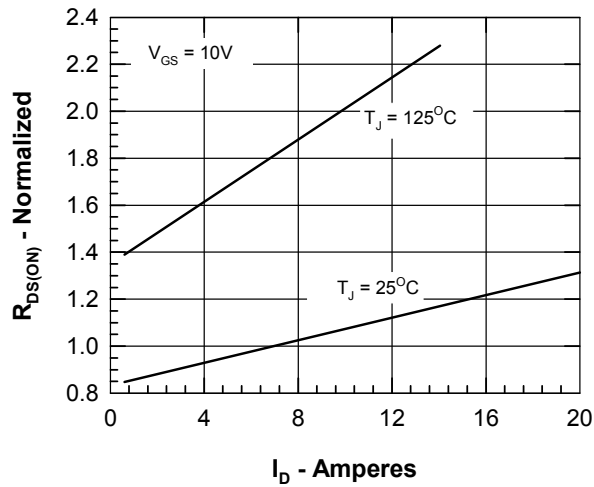

Figure 3. $R_{DS(on)}$ normalized to value at $I_D = 12A$

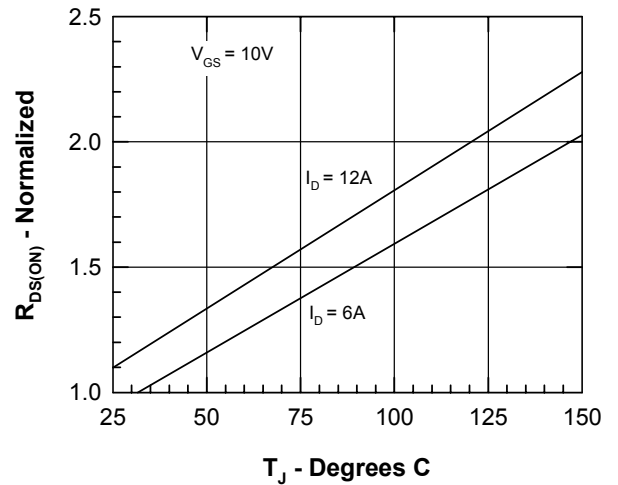

Figure 4. $R_{DS(on)}$ normalized to value at $I_D = 12A$

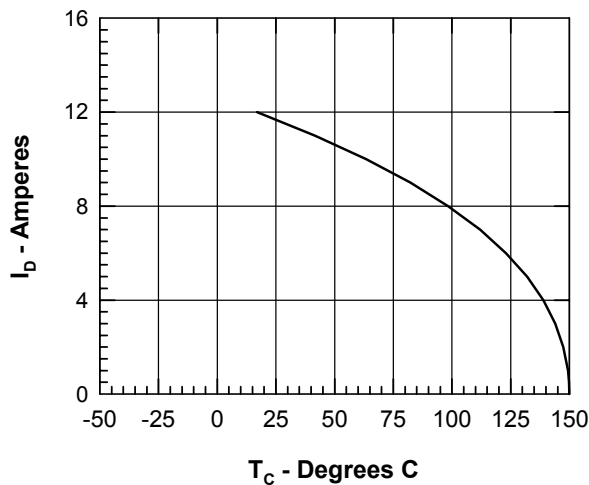

Figure 5. Drain Current vs. Case Temperature

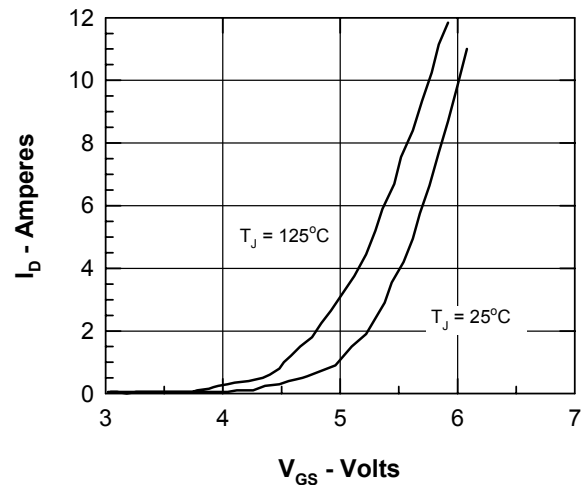

Figure 6. Admittance Curves

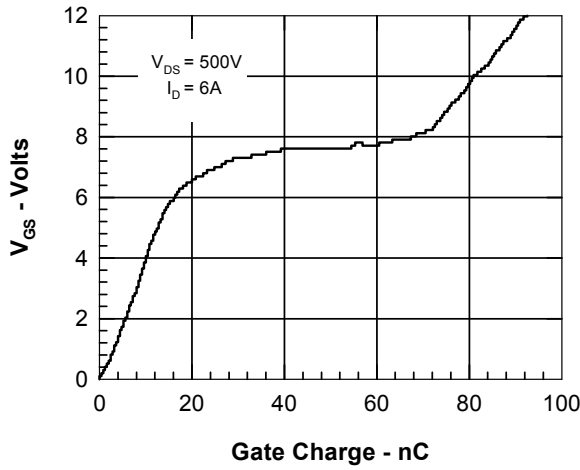

Figure 7. Gate Charge

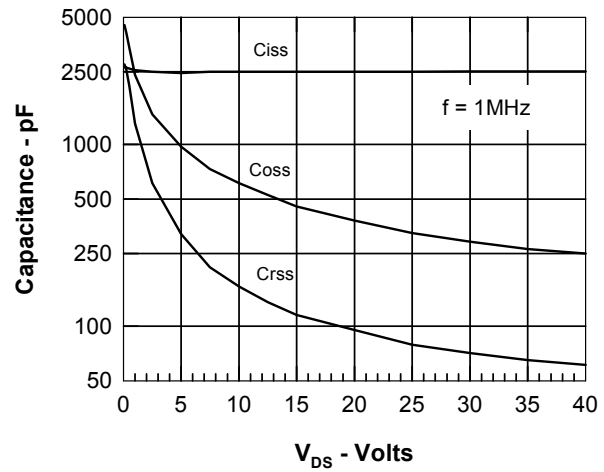

Figure 8. Capacitance Curves

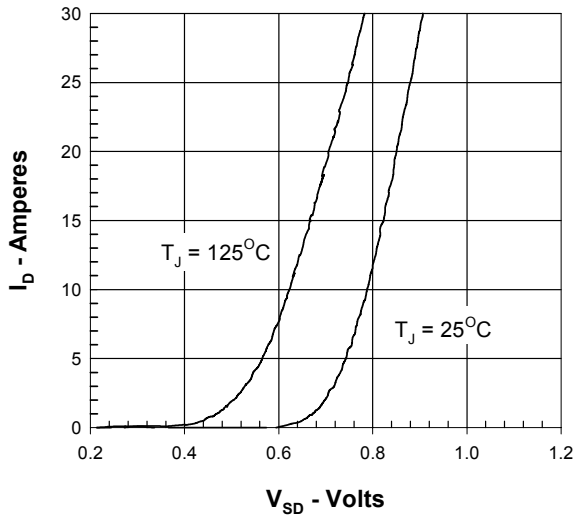

Figure 9. Source Current vs. Source to Drain Voltage

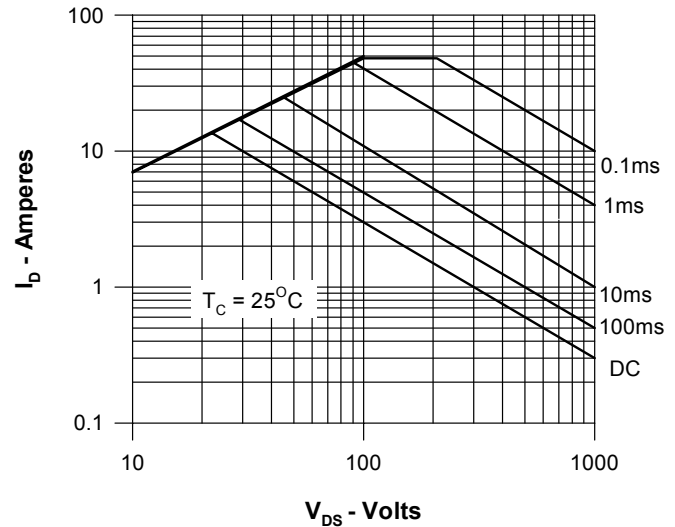

Figure 10. Forward Bias Safe Operating Area

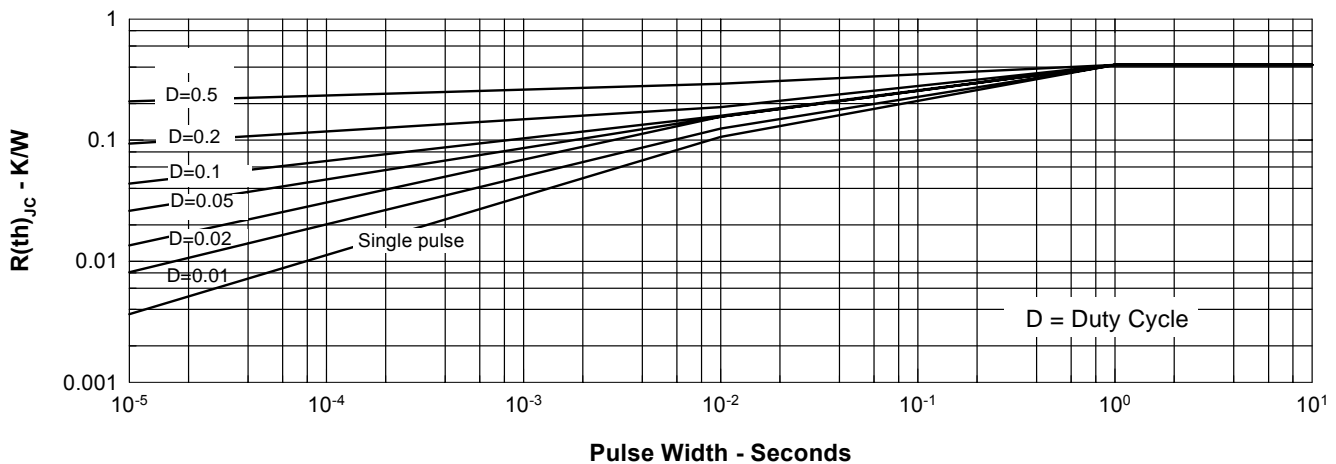

Figure 11. Transient Thermal Resistance

IXYS reserves the right to change limits, test conditions, and dimensions.

 IXYS MOSFETs and IGBTs are covered by one or more of the following U.S. patents:

4,835,592	4,881,106	5,017,508	5,049,961	5,187,117	5,486,715	6,306,728B1
4,850,072	4,931,844	5,034,796	5,063,307	5,237,481	5,381,025	