

# HiPerFET™

## Power MOSFETs

### Q-Class

N-Channel Enhancement Mode  
Avalanche Rated, Low  $Q_g$ , High  $dv/dt$

IXFH/IXFT 24N50Q  
IXFH/IXFT 26N50Q

$V_{DSS}$	$I_{D25}$	$R_{DS(on)}$
500 V	24 A	0.23 $\Omega$
500 V	26 A	0.20 $\Omega$

$t_{rr} \leq 250$  ns

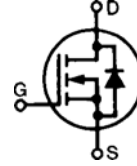

Symbol	Test Conditions	Maximum Ratings	
$V_{DSS}$	$T_J = 25^\circ\text{C}$ to $150^\circ\text{C}$	500	V
$V_{DGR}$	$T_J = 25^\circ\text{C}$ to $150^\circ\text{C}$ ; $R_{GS} = 1$ M $\Omega$	500	V
$V_{GS}$	Continuous	$\pm 20$	V
$V_{GSM}$	Transient	$\pm 30$	V
$I_{D25}$	$T_C = 25^\circ\text{C}$	24N50Q	24 A
		26N50Q	26 A
$I_{DM}$	$T_C = 25^\circ\text{C}$ , Note 1	24N50Q	96 A
		26N50Q	104 A
$I_{AR}$	$T_C = 25^\circ\text{C}$	24N50Q	24 A
		26N50Q	26 A
$E_{AR}$	$T_C = 25^\circ\text{C}$	30	mJ
$E_{AS}$	$T_C = 25^\circ\text{C}$	1.5	J
$dv/dt$	$I_S \leq I_{DM}$ ; $di/dt \leq 100$ A/ $\mu\text{s}$ ; $V_{DD} \leq V_{DSS}$ ; $T_J \leq 150^\circ\text{C}$ ; $R_G = 2$ $\Omega$	5	V/ns
$P_D$	$T_C = 25^\circ\text{C}$	300	W
$T_J$		-55 ... +150	$^\circ\text{C}$
$T_{JM}$		150	$^\circ\text{C}$
$T_{stg}$		-55 ... +150	$^\circ\text{C}$
$T_L$	1.6 mm (0.063 in) from case for 10 s	300	$^\circ\text{C}$
$M_d$	Mounting torque	1.13/10	Nm/lb.in.
Weight	TO-247	6	g
	TO-268	4	g

TO-247 AD (IXFH)

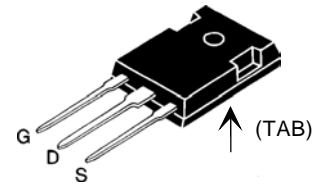

TO-268 (D3) (IXFT) Case Style

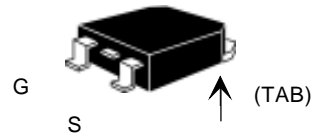

G = Gate, D = Drain,  
S = Source, TAB = Drain

#### Features

- IXYS advanced low  $Q_g$  process
- International standard packages
- Low  $R_{DS(on)}$
- Unclamped Inductive Switching (UIS) rated
- Fast switching
- Molding epoxies meet UL 94 V-0 flammability classification

#### Advantages

- Easy to mount
- Space savings
- High power density

Symbol	Test Conditions	Characteristic Values		
		$(T_J = 25^\circ\text{C}$ , unless otherwise specified)		
		min.	typ.	max.
$V_{DSS}$	$V_{GS} = 0$ V, $I_D = 250$ $\mu\text{A}$	500		V
$V_{GS(th)}$	$V_{DS} = V_{GS}$ , $I_D = 4$ mA	2.5		4.5 V
$I_{GSS}$	$V_{GS} = \pm 20$ V $_{DC}$ , $V_{DS} = 0$			$\pm 100$ nA
$I_{DSS}$	$V_{DS} = V_{DSS}$ $V_{GS} = 0$ V	$T_J = 25^\circ\text{C}$		25 $\mu\text{A}$
		$T_J = 125^\circ\text{C}$		1 mA
$R_{DS(on)}$	$V_{GS} = 10$ V, $I_D = 0.5$ $I_{D25}$ Note 2	24N50Q		0.23 $\Omega$
		26N50Q		0.20 $\Omega$

Symbol	Test Conditions	Characteristic Values		
		$(T_J = 25^\circ\text{C}, \text{ unless otherwise specified})$		
		min.	typ.	max.
$g_{fs}$	$V_{DS} = 10\text{ V}; I_D = 0.5 \cdot I_{D25}$ , Note 2	14	24	S
$C_{iss}$	$V_{GS} = 0\text{ V}, V_{DS} = 25\text{ V}, f = 1\text{ MHz}$		3900	pF
$C_{oss}$			500	pF
$C_{rss}$			130	pF
$t_{d(on)}$	$V_{GS} = 10\text{ V}, V_{DS} = 0.5 \cdot V_{DSS}, I_D = 0.5 \cdot I_{D25}$ $R_G = 2\ \Omega$ (External),		28	ns
$t_r$			30	ns
$t_{d(off)}$			55	ns
$t_f$			16	ns
$Q_{g(on)}$	$V_{GS} = 10\text{ V}, V_{DS} = 0.5 \cdot V_{DSS}, I_D = 0.5 \cdot I_{D25}$		95	nC
$Q_{gs}$			27	nC
$Q_{gd}$			40	nC
$R_{thJC}$	(TO-247)			0.42 KW
$R_{thCK}$			0.25	

Source-Drain Diode		Characteristic Values		
		$(T_J = 25^\circ\text{C}, \text{ unless otherwise specified})$		
Symbol	Test Conditions	min.	typ.	max.
$I_S$	$V_{GS} = 0\text{ V}$	24N50Q 26N50Q		24 26 A
$I_{SM}$	Repetitive; Note 1	24N50Q 26N50Q		96 104 A
$V_{SD}$	$I_F = I_S, V_{GS} = 0\text{ V},$ Pulse test, $t \leq 300\ \mu\text{s}$ , duty cycle $d \leq 2\%$			1.3 V
$t_{rr}$	$I_F = I_S, -di/dt = 100\text{ A}/\mu\text{s}, V_R = 100\text{ V}$		0.85	250 ns
$Q_{RM}$				$\mu\text{C}$
$I_{RM}$			8	A

Note 1. Pulse width limited by  $T_{JM}$   
 2. Pulse test,  $t \leq 300\ \mu\text{s}$ , duty cycle  $d \leq 2\%$

### Min Recommended Footprint

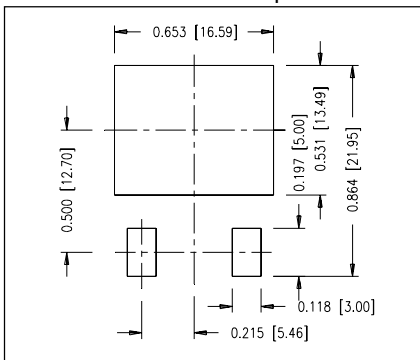

### TO-247 AD Outline

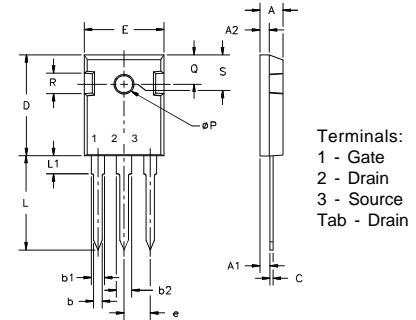

Dim.	Millimeter		Inches	
	Min.	Max.	Min.	Max.
A	4.7	5.3	.185	.209
A <sub>1</sub>	2.2	2.54	.087	.102
A <sub>2</sub>	2.2	2.6	.059	.098
b	1.0	1.4	.040	.055
b <sub>1</sub>	1.65	2.13	.065	.084
b <sub>2</sub>	2.87	3.12	.113	.123
C	.4	.8	.016	.031
D	20.80	21.46	.819	.845
E	15.75	16.26	.610	.640
e	5.20	5.72	0.205	0.225
L	19.81	20.32	.780	.800
L1		4.50		.177
ØP	3.55	3.65	.140	.144
Q	5.89	6.40	0.232	0.252
R	4.32	5.49	.170	.216
S	6.15 BSC		242 BSC	

### TO-268 Outline

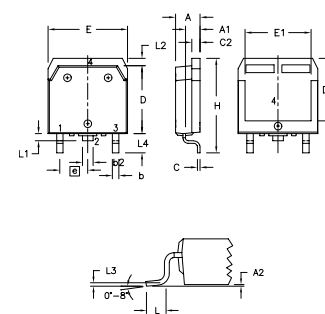

Dim.	Millimeter		Inches	
	Min.	Max.	Min.	Max.
A	4.9	5.1	.193	.201
A <sub>1</sub>	2.7	2.9	.106	.114
A <sub>2</sub>	.02	.25	.001	.010
b	1.15	1.45	.045	.057
b <sub>1</sub>	1.9	2.1	.075	.083
b <sub>2</sub>	.4	.65	.016	.026
D	13.80	14.00	.543	.551
E	15.85	16.05	.624	.632
E <sub>1</sub>	13.3	13.6	.524	.535
e	5.45 BSC		.215 BSC	
H	18.70	19.10	.736	.752
L	2.40	2.70	.094	.106
L1	1.20	1.40	.047	.055
L2	1.00	1.15	.039	.045
L3	0.25 BSC		.010 BSC	
L4	3.80	4.10	.150	.161

IXYS reserves the right to change limits, test conditions, and dimensions.

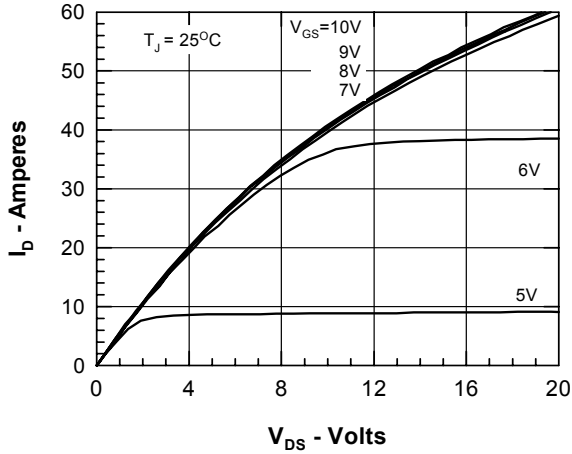

Fig.1 Output Characteristics @  $T_J = 25^\circ\text{C}$

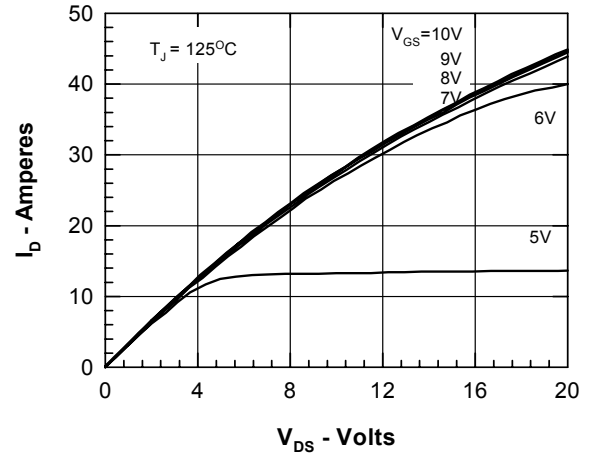

Fig.2 Output Characteristics @  $T_J = 125^\circ\text{C}$

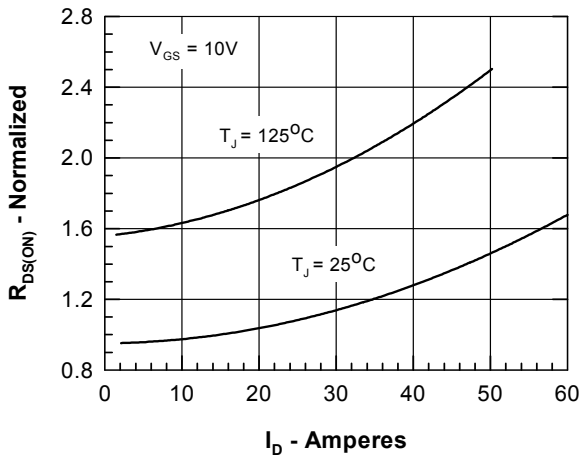

Fig.3  $R_{DS(on)}$  vs. Drain Current

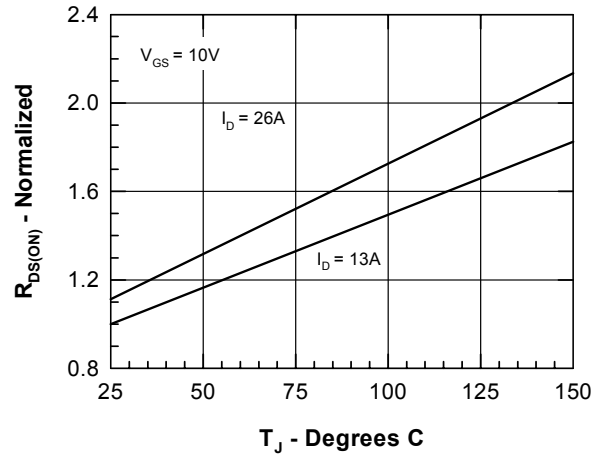

Fig.4 Temperature Dependence of Drain to Source Resistance

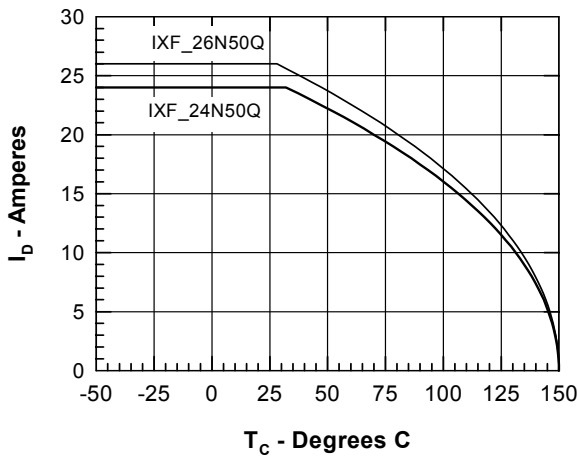

Fig.5 Drain Current vs. Case Temperature

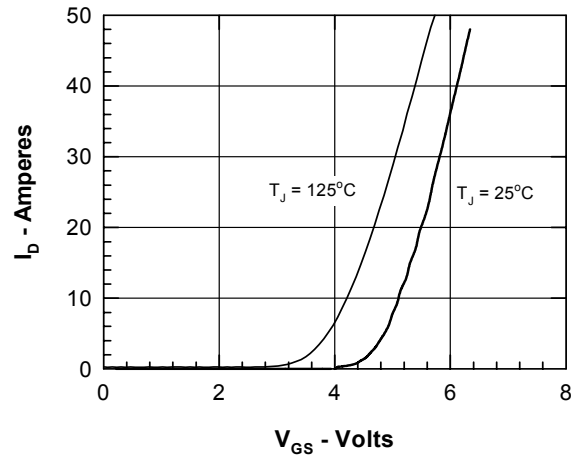

Fig.6 Drain Current vs. Gate Source Voltage

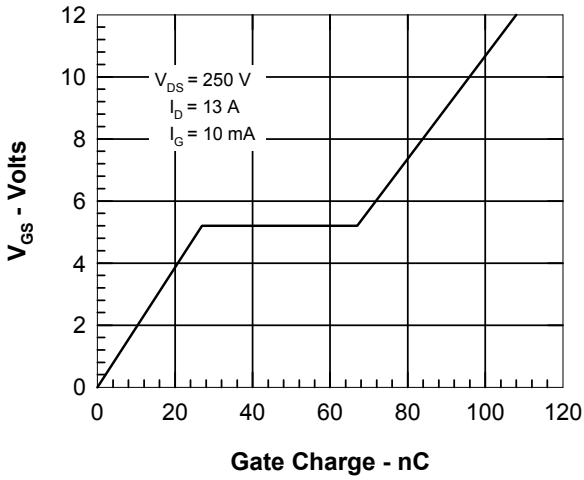

Fig.7 Gate Charge Characteristic Curve

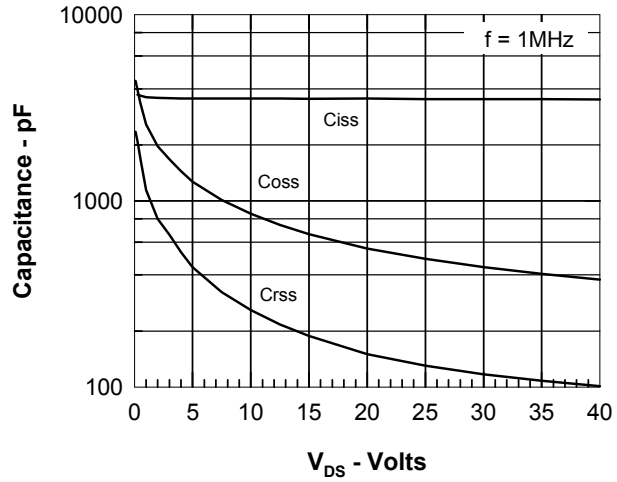

Fig.8 Capacitance Curves

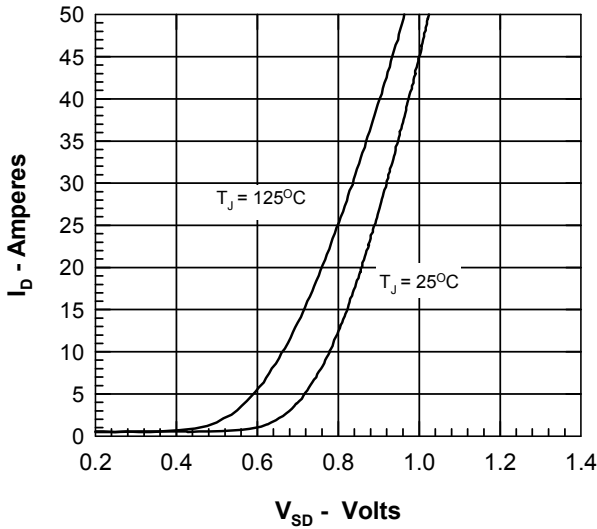

Fig.9 Drain Current vs Drain to Source Voltage

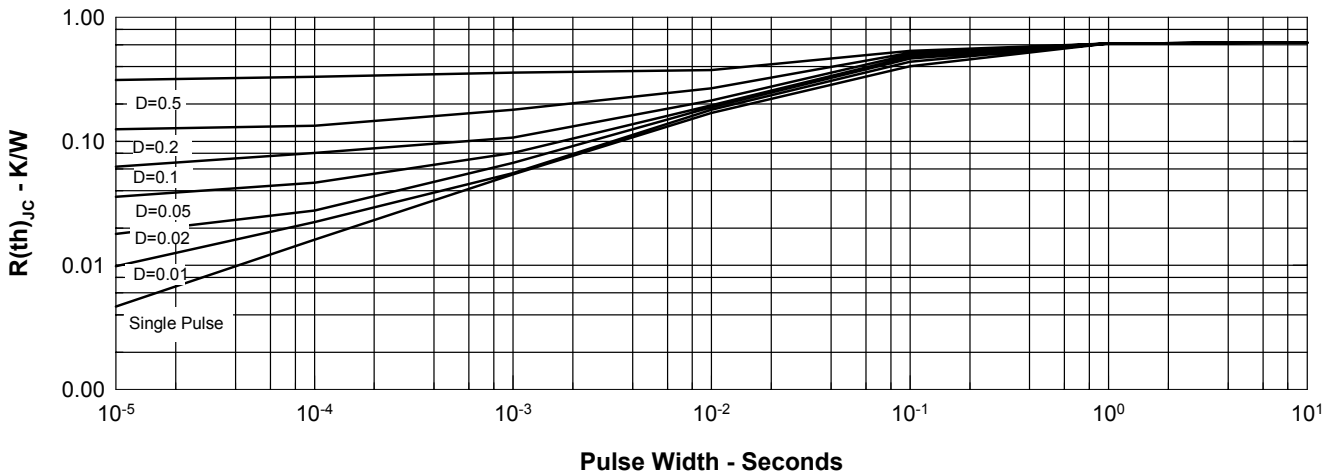

Fig.10 Transient Thermal Impedance

IXYS reserves the right to change limits, test conditions, and dimensions.

IXYS MOSFETS and IGBTs are covered by one or more of the following U.S. patents:

4,835,592	4,881,106	5,017,508	5,049,961	5,187,117	5,486,715	6,306,728B1
4,850,072	4,931,844	5,034,796	5,063,307	5,237,481	5,381,025	