

HiPerFET™

Power MOSFETs

Q2-Class

IXFH40N50Q2

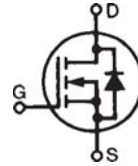

N-Channel Enhancement Mode
 Avalanche Rated, High dv/dt, Low Q_g
 Low intrinsic R_g , low t_{rr}

$V_{DSS} = 500V$
 $I_{D25} = 40A$
 $R_{DS(on)} \leq 160m\Omega$
 $t_{rr} \leq 250ns$

TO-247 (IXFH)

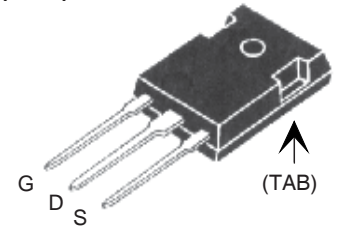

G = Gate D = Drain
 S = Source TAB = Drain

Symbol	Test Conditions	Maximum Ratings	
V_{DSS}	$T_J = 25^\circ C$ to $150^\circ C$	500	V
V_{DGR}	$T_J = 25^\circ C$ to $150^\circ C$, $R_{GS} = 1M\Omega$	500	V
V_{GSS}	Continuous	± 30	V
V_{GSM}	Transient	± 40	V
I_{D25}	$T_C = 25^\circ C$	40	A
I_{DM}	$T_C = 25^\circ C$, pulse width limited by T_{JM}	160	A
I_A	$T_C = 25^\circ C$	40	A
E_{AS}	$T_C = 25^\circ C$	2.5	J
dV/dt	$I_S \leq I_{DM}$, $V_{DD} \leq V_{DSS}$, $T_J \leq 150^\circ C$	20	V/ns
P_D	$T_C = 25^\circ C$	560	W
T_J		-55 ... +150	$^\circ C$
T_{JM}		150	$^\circ C$
T_{stg}		-55 ... +150	$^\circ C$
T_L	1.6mm (0.063 in) from case for 10s	300	$^\circ C$
M_d	Mounting torque	1.13/10	Nm/lb.in.
Weight		6	g

Features

- Double metal process for low gate resistance
- International standard package
- Epoxy meet UL94 V-0, flammability classification
- Avalanche energy and current rated
- Fast intrinsic Rectifier

Applications

- DC-DC converters
- Switched-mode and resonant-mode power supplies, >500kHz switching
- DC choppers
- Pulse generation
- Laser drivers

Advantages

- Easy to mount
- Space savings
- High power density

Symbol	Test Conditions	Characteristic Values		
		Min.	Typ.	Max.
V_{DSS}	$V_{GS} = 0V$, $I_D = 250\mu A$	500		V
$V_{GS(th)}$	$V_{DS} = V_{GS}$, $I_D = 4mA$	3.0		5.5 V
I_{GSS}	$V_{GS} = \pm 30V$, $V_{DS} = 0V$			± 200 nA
I_{DSS}	$V_{DS} = V_{DSS}$ $V_{GS} = 0V$ $T_J = 125^\circ C$			25 μA 1 mA
$R_{DS(on)}$	$V_{GS} = 10V$, $I_D = 0.5 \cdot I_{D25}$, Note 1			160 m Ω

Symbol	Test Conditions ($T_J = 25^\circ\text{C}$, unless otherwise specified)	Characteristic Values		
		Min.	Typ.	Max.
g_{fs}	$V_{DS} = 10\text{V}, I_D = 0.5 \cdot I_{D25}$, Note 1	15	28	S
C_{iss}	$V_{GS} = 0\text{V}, V_{DS} = 25\text{V}, f = 1\text{MHz}$		4850	pF
C_{oss}			680	pF
C_{rss}			170	pF
$t_{d(on)}$	Resistive Switching Times		17	ns
t_r	$V_{GS} = 10\text{V}, V_{DS} = 0.5 \cdot V_{DSS}, I_D = 0.5 \cdot I_{D25}$		13	ns
$t_{d(off)}$	$R_G = 2\Omega$ (External)		42	ns
t_f			8	ns
$Q_{g(on)}$	$V_{GS} = 10\text{V}, V_{DS} = 0.5 \cdot V_{DSS}, I_D = 0.5 \cdot I_{D25}$		110	nC
Q_{gs}			25	nC
Q_{gd}			50	nC
R_{thJC}			0.22	$^\circ\text{C/W}$
R_{thCK}		0.21		$^\circ\text{C/W}$

TO-247 (IXFH) Outline

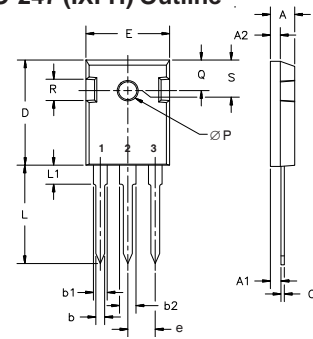

Terminals: 1 - Gate 2 - Drain

Dim.	Millimeter		Inches	
	Min.	Max.	Min.	Max.
A	4.7	5.3	.185	.209
A ₁	2.2	2.54	.087	.102
A ₂	2.2	2.6	.059	.098
b	1.0	1.4	.040	.055
b ₁	1.65	2.13	.065	.084
b ₂	2.87	3.12	.113	.123
C	.4	.8	.016	.031
D	20.80	21.46	.819	.845
E	15.75	16.26	.610	.640
e	5.20	5.72	0.205	0.225
L	19.81	20.32	.780	.800
L1		4.50		.177
∅P	3.55	3.65	.140	.144
Q	5.89	6.40	0.232	0.252
R	4.32	5.49	.170	.216

Source-Drain Diode

Symbol	Test Conditions ($T_J = 25^\circ\text{C}$, unless otherwise specified)	Characteristic Values		
		Min.	Typ.	Max.
I_S	$V_{GS} = 0\text{V}$			40 A
I_{SM}	Repetitive, pulse width limited by T_{JM}			160 A
V_{SD}	$I_F = I_S, V_{GS} = 0\text{V}$, Note 1			1.5 V
t_{rr}	$I_F = 25\text{A}, -di/dt = 100\text{A}/\mu\text{s}, V_R = 100\text{V}$			250 ns
Q_{RM}			1	μC
I_{RM}			9	A

Notes: 1. Pulse test, $t \leq 300\mu\text{s}$; duty cycle, $d \leq 2\%$.

IXYS reserves the right to change limits, test conditions, and dimensions.

IXYS MOSFETs and IGBTs are covered by one or more of the following U.S. patents:

4,835,592	4,931,844	5,049,961	5,237,481	6,162,665	6,404,065 B1	6,683,344	6,727,585	7,005,734 B2	7,157,338 B2
4,850,072	5,017,508	5,063,307	5,381,025	6,259,123 B1	6,534,343	6,710,405 B2	6,759,692	7,063,975 B2	
4,881,106	5,034,796	5,187,117	5,486,715	6,306,728 B1	6,583,505	6,710,463	6,771,478 B2	7,071,537	

Fig. 1. Output Characteristics @ 25°C

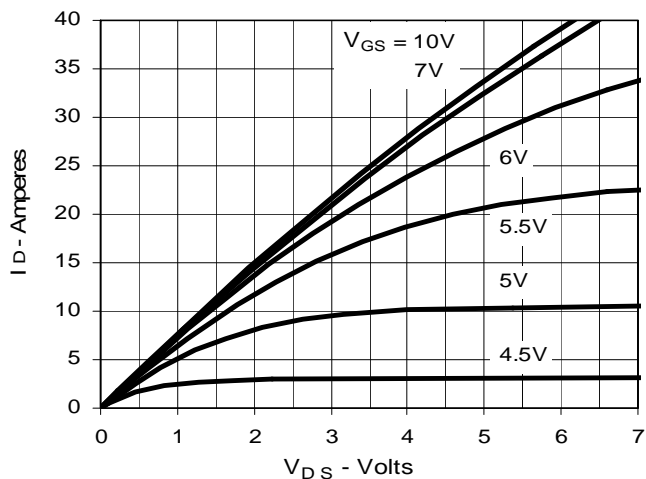

Fig. 2. Extended Output Characteristics @ 25°C

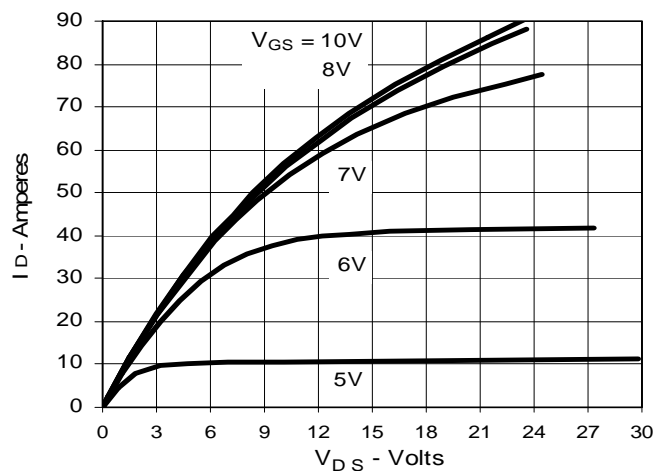

Fig. 3. Output Characteristics @ 125°C

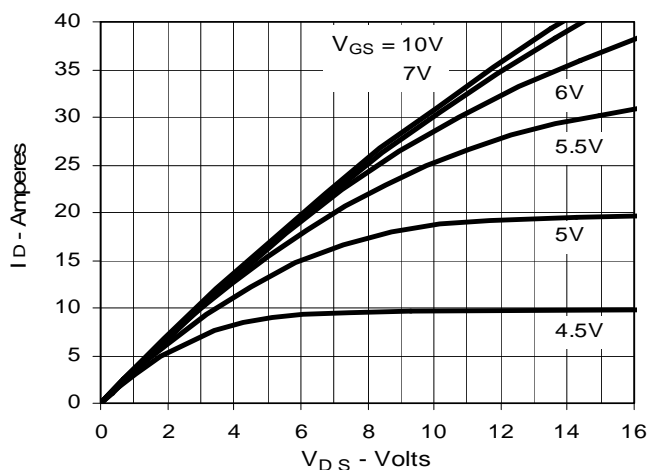

Fig. 4. $R_{DS(on)}$ Normalized to 0.5 I_{D25} Value vs. Junction Temperature

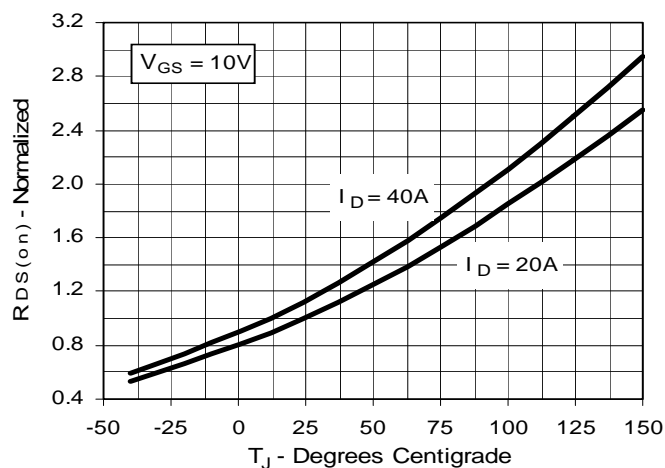

Fig. 5. $R_{DS(on)}$ Normalized to 0.5 I_{D25} Value vs. I_D

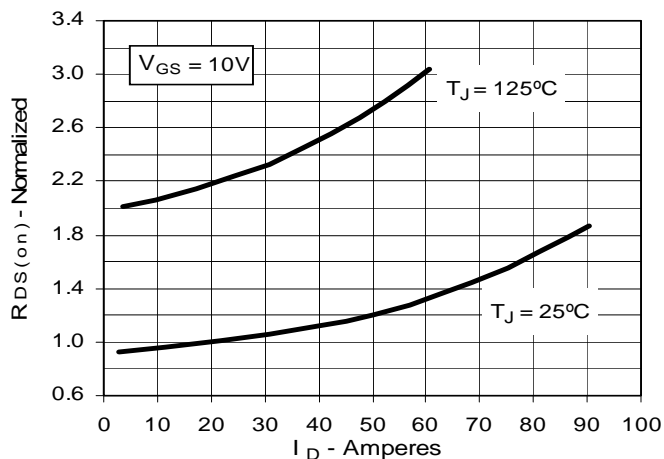

Fig. 6. Drain Current vs. Case Temperature

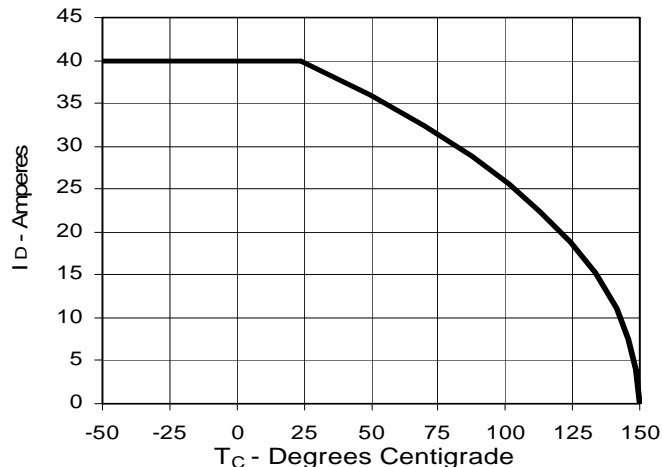

Fig. 7. Input Admittance

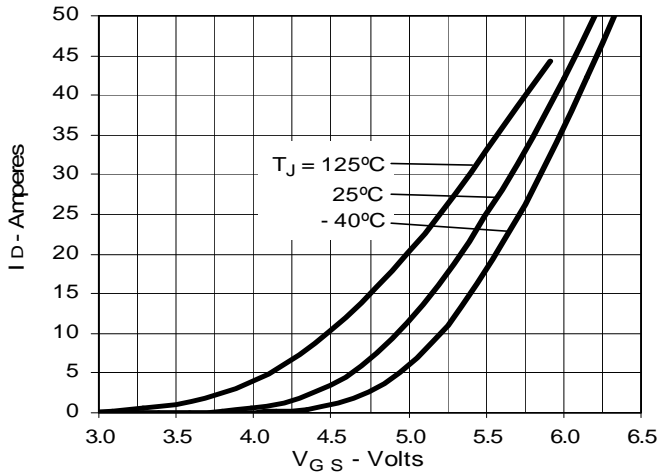

Fig. 8. Transconductance

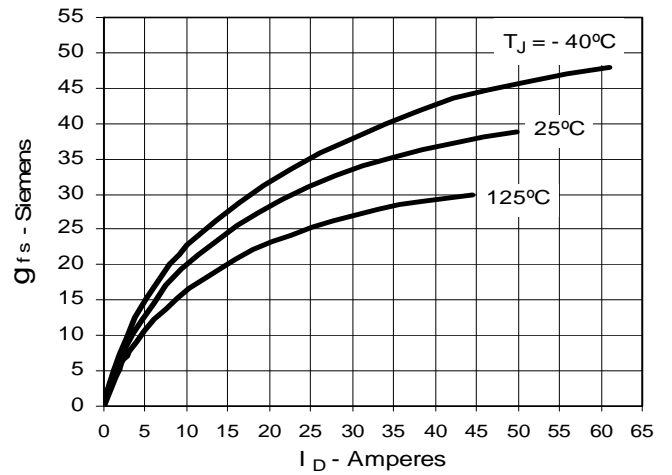

Fig. 9. Source Current vs. Source-To-Drain Voltage

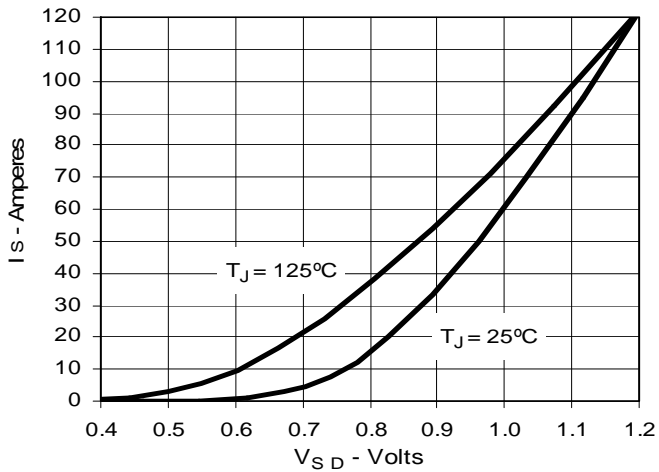

Fig. 10. Gate Charge

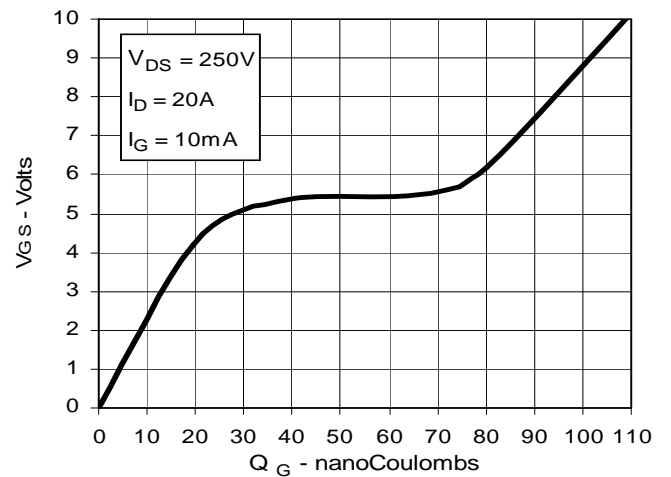

Fig. 11. Capacitance

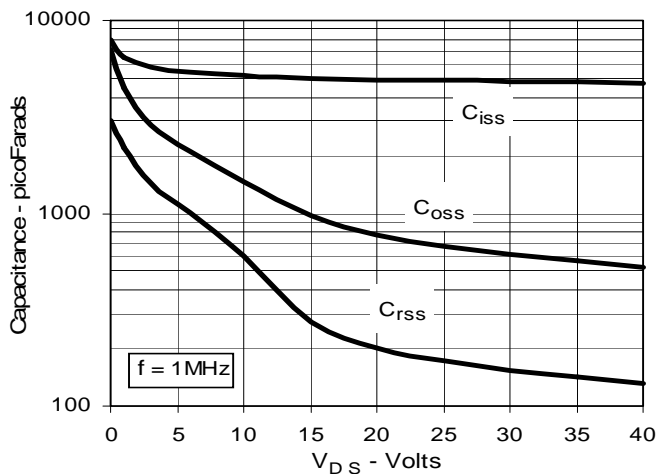

Fig. 12. Forward-Bias Safe Operating Area

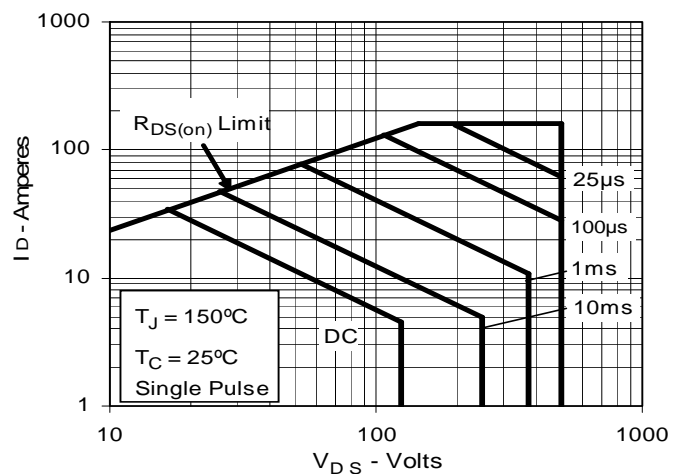

Fig. 13. Maximum Transient Thermal Impedance

