

HiPerFET™ Power MOSFETs

N-Channel Enhancement Mode
High dv/dt, Low t_{rr} , HDMOS™ Family

IXFH/IXFM 10 N90
IXFH/IXFM 12 N90
IXFH/IXFT 13 N90



V_{DSS}	I_{D25}	$R_{DS(on)}$
900 V	10 A	1.1 Ω
900 V	12 A	0.9 Ω
900 V	13 A	0.8 Ω

$t_{rr} \leq 250$ ns

TO-247 AD (IXFH)

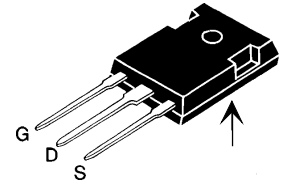

(TAB)

TO-204 AA (IXFM)

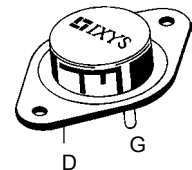

TO-268 (IXFT)



G = Gate, D = Drain,
S = Source, TAB = Drain

Symbol	Test Conditions	Maximum Ratings	
V_{DSS}	$T_J = 25^\circ\text{C}$ to 150°C	900	V
V_{DGR}	$T_J = 25^\circ\text{C}$ to 150°C ; $R_{GS} = 1$ M Ω	900	V
V_{GS}	Continuous	± 20	V
V_{GSM}	Transient	± 30	V
I_{D25}	$T_C = 25^\circ\text{C}$	10N90: 10 12N90: 12 13N90: 13	A
I_{DM}	$T_C = 25^\circ\text{C}$, pulse width limited by T_{JM}	10N90: 40 12N90: 48 13N90: 52	A
I_{AR}	$T_C = 25^\circ\text{C}$	10N90: 10 12N90: 12 13N90: 13	A
E_{AR}	$T_C = 25^\circ\text{C}$	30	mJ
dv/dt	$I_S \leq I_{DM}$, di/dt ≤ 100 A/ μs , $V_{DD} \leq V_{DSS}$, $T_J \leq 150^\circ\text{C}$, $R_G = 2$ Ω	5	V/ns
P_D	$T_C = 25^\circ\text{C}$	300	W
T_J		-55 ... +150	$^\circ\text{C}$
T_{JM}		150	$^\circ\text{C}$
T_{stg}		-55 ... +150	$^\circ\text{C}$
T_L	1.6 mm (0.062 in.) from case for 10 s	300	$^\circ\text{C}$
M_d	Mounting torque	1.13/10	Nm/lb.in.
Weight		TO-204 = 18 g, TO-247 = 6 g	

Features

- International standard packages
- Low $R_{DS(on)}$ HDMOS™ process
- Rugged polysilicon gate cell structure
- Unclamped Inductive Switching (UIS) rated
- Low package inductance
- easy to drive and to protect
- Fast intrinsic Rectifier

Applications

- DC-DC converters
- Synchronous rectification
- Battery chargers
- Switched-mode and resonant-mode power supplies
- DC choppers
- AC motor control
- Temperature and lighting controls
- Low voltage relays

Advantages

- Easy to mount with 1 screw (TO-247) (isolated mounting screw hole)
- Space savings
- High power density

Symbol	Test Conditions	Characteristic Values ($T_J = 25^\circ\text{C}$, unless otherwise specified)		
		min.	typ.	max.
V_{DSS}	$V_{GS} = 0$ V, $I_D = 3$ mA	900		V
$V_{GS(th)}$	$V_{DS} = V_{GS}$, $I_D = 4$ mA	2.0		4.5 V
I_{GSS}	$V_{GS} = \pm 20$ V $_{DC}$, $V_{DS} = 0$			± 100 nA
I_{DSS}	$V_{DS} = V_{DSS}$, $T_J = 25^\circ\text{C}$ $V_{GS} = 0$ V, $T_J = 125^\circ\text{C}$			25 μA 1 mA
$R_{DS(on)}$	$V_{GS} = 10$ V, $I_D = 0.5 \cdot I_{D25}$ Pulse test, $t \leq 300$ μs , duty cycle $d \leq 2$ %	10N90 12N90 13N90		1.1 Ω 0.9 Ω 0.8 Ω

Symbol	Test Conditions	Characteristic Values ($T_J = 25^\circ\text{C}$, unless otherwise specified)		
		min.	typ.	max.
g_{fs}	$V_{DS} = 10\text{ V}; I_D = 0.5 \cdot I_{D25}$, pulse test	6	12	S
C_{iss}	$V_{GS} = 0\text{ V}, V_{DS} = 25\text{ V}, f = 1\text{ MHz}$		4200	pF
C_{oss}			315	pF
C_{rss}			90	pF
$t_{d(on)}$	$V_{GS} = 10\text{ V}, V_{DS} = 0.5 \cdot V_{DSS}, I_D = 0.5 \cdot I_{D25}$ $R_G = 2\ \Omega$ (External)	18	50	ns
t_r		12	50	ns
$t_{d(off)}$		51	100	ns
t_f		18	50	ns
$Q_{g(on)}$	$V_{GS} = 10\text{ V}, V_{DS} = 0.5 \cdot V_{DSS}, I_D = 0.5 \cdot I_{D25}$	123	155	nC
Q_{gs}		27	45	nC
Q_{gd}		49	80	nC
R_{thJC}	(IXFH/IXFM)		0.42	K/W
R_{thCK}		0.25	K/W	

Source-Drain Diode		Characteristic Values ($T_J = 25^\circ\text{C}$, unless otherwise specified)		
Symbol	Test Conditions	min.	typ.	max.
I_S	$V_{GS} = 0\text{ V}$	10N90		10 A
		12N90		12 A
		13N90		13 A
I_{SM}	Repetitive; pulse width limited by T_{JM}	10N90		40 A
		12N90		48 A
		13N90		52 A
V_{SD}	$I_F = I_S, V_{GS} = 0\text{ V},$ Pulse test, $t \leq 300\ \mu\text{s}$, duty cycle $d \leq 2\%$			1.5 V
t_{tr}	$I_F = I_S$ $-di/dt = 100\text{ A}/\mu\text{s},$ $V_R = 100\text{ V}$	$T_J = 25^\circ\text{C}$		250 ns
		$T_J = 125^\circ\text{C}$		400 ns
Q_{RM}		$T_J = 25^\circ\text{C}$	1	μC
		$T_J = 125^\circ\text{C}$	2	μC
I_{RM}		$T_J = 25^\circ\text{C}$	10	A
		$T_J = 125^\circ\text{C}$	15	A

TO-268 (IXFT) Outline

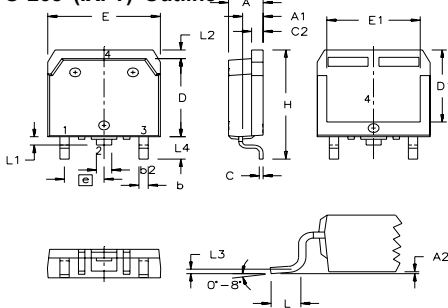

SYM	INCHES		MILLIMETERS	
	MIN	MAX	MIN	MAX
A	.193	.201	4.90	5.10
A1	.106	.114	2.70	2.90
A2	.001	.010	0.02	0.25
b	.045	.057	1.15	1.45
b2	.075	.083	1.90	2.10
C	.016	.026	0.40	0.65
C2	.057	.063	1.45	1.60
D	.543	.551	13.80	14.00
D1	.488	.500	12.40	12.70
E	.624	.632	15.85	16.05
E1	.524	.535	13.30	13.60
e	.215 BSC		5.45 BSC	
H	.736	.752	18.70	19.10
L1	.094	.106	2.40	2.70
L2	.047	.055	1.20	1.40
L3	.039	.045	1.00	1.15
L4	.010 BSC		0.25 BSC	
L4	.150	.161	3.80	4.10

IXYS reserves the right to change limits, test conditions, and dimensions.

TO-247 AD (IXFH) Outline

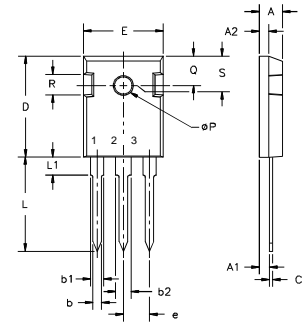

Terminals: 1 - Gate 2 - Drain
3 - Source Tab - Drain

Dim.	Millimeter		Inches	
	Min.	Max.	Min.	Max.
A	4.7	5.3	.185	.209
A ₁	2.2	2.54	.087	.102
A ₂	2.2	2.6	.059	.098
b	1.0	1.4	.040	.055
b ₁	1.65	2.13	.065	.084
b ₂	2.87	3.12	.113	.123
C	.4	.8	.016	.031
D	20.80	21.46	.819	.845
E	15.75	16.26	.610	.640
e	5.20	5.72	0.205	0.225
L	19.81	20.32	.780	.800
L1		4.50		.177
∅P	3.55	3.65	.140	.144
Q	5.89	6.40	0.232	0.252
R	4.32	5.49	.170	.216
S	6.15	BSC	242	BSC

TO-204 AA (IXFM) Outline

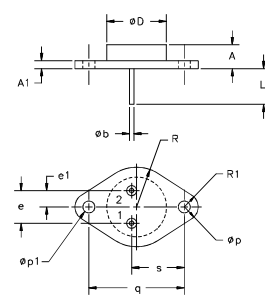

Pins 1 - Gate 2 - Source
Case - Drain

Dim.	Millimeter		Inches	
	Min.	Max.	Min.	Max.
A	6.4	11.4	.250	.450
A1		3.42		.135
∅b	.97	1.09	.038	.043
∅D	22.22		.875	
e	10.67	11.17	.420	.440
e1	5.21	5.71	.205	.225
L	7.93		.312	
∅p	3.84	4.19	.151	.165
∅p1	3.84	4.19	.151	.165
q	30.15 BSC		1.187 BSC	
R	13.33		.525	
R1	4.77		.188	
s	16.64	17.14	.655	.675

Fig. 1. Output Characteristics

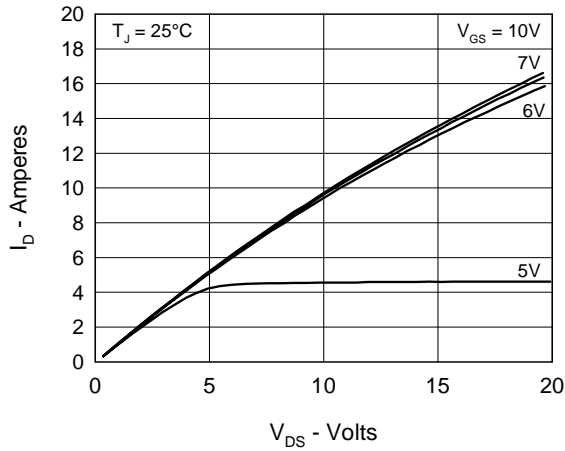

Fig. 2. Input Admittance

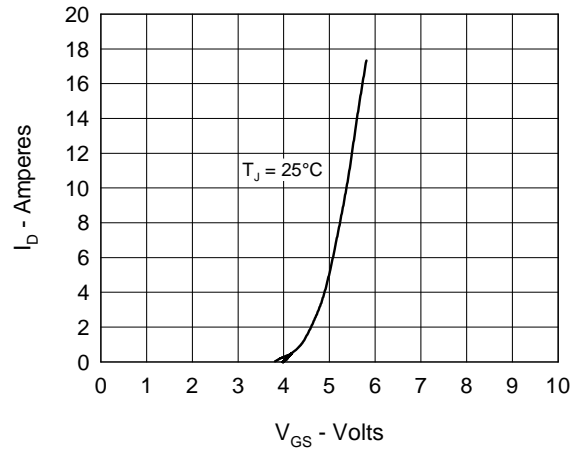

Fig. 3. $R_{DS(on)}$ vs. Drain Current

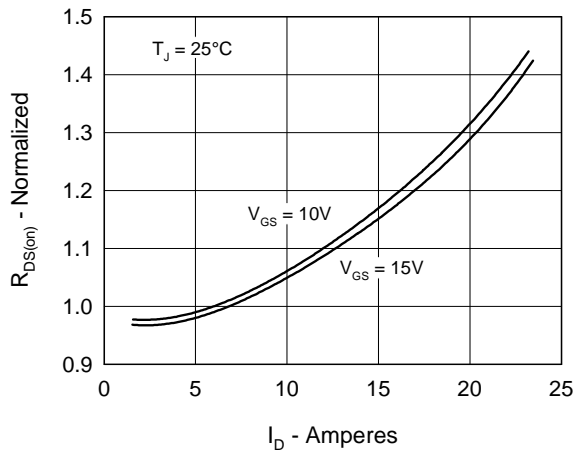

Fig. 4. Temperature Dependence of Drain to Source Resistance

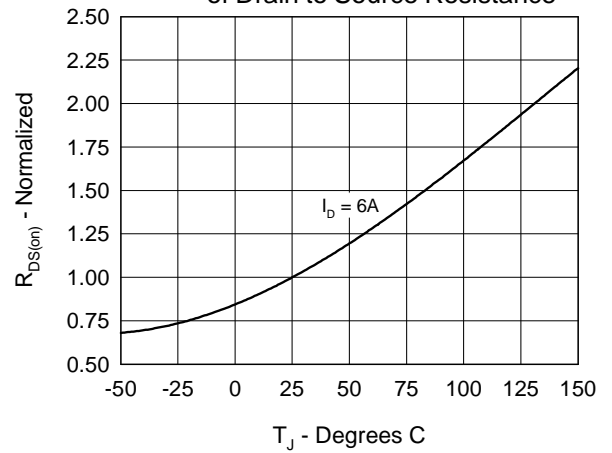

Fig. 5. Drain Current vs. Case Temperature

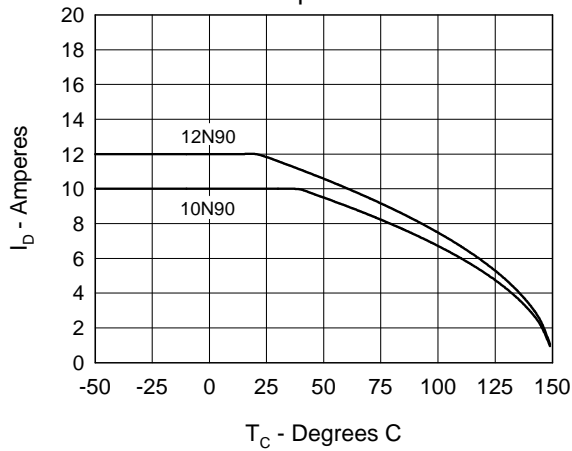

Fig. 6. Temperature Dependence of Breakdown and Threshold Voltage

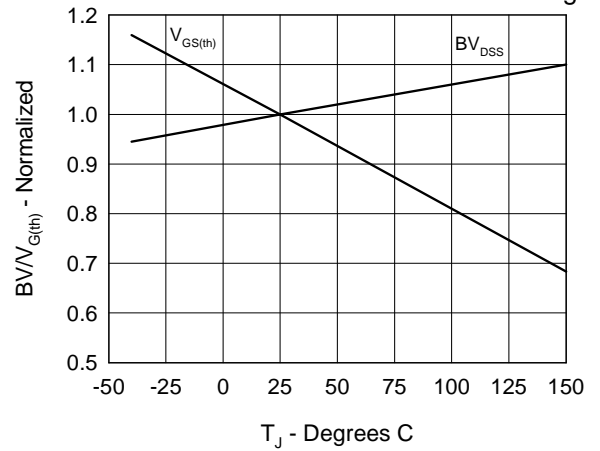

Fig.7. Gate Charge Characteristic Curve

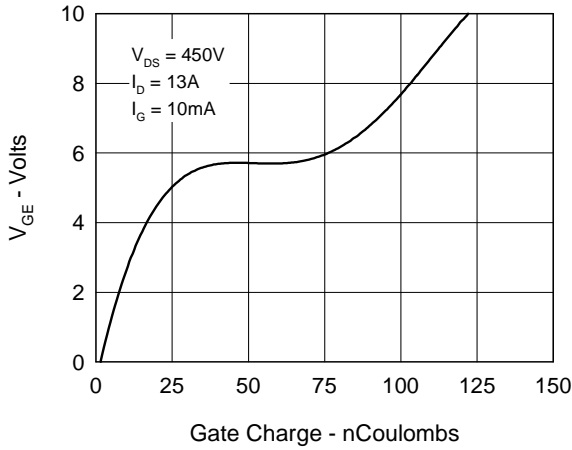

Fig.8. Capacitance Curves

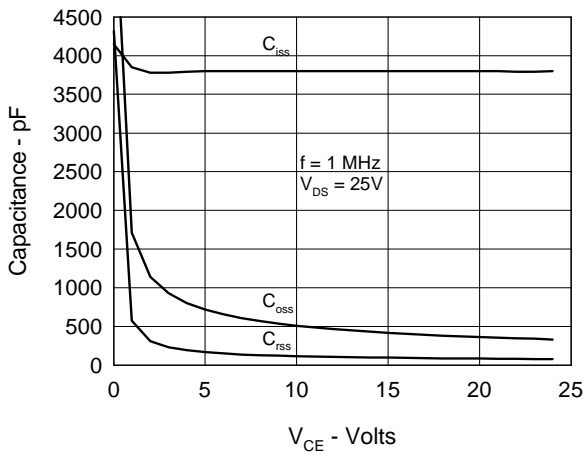

Fig.9. Source Current vs. Source to Drain Voltage

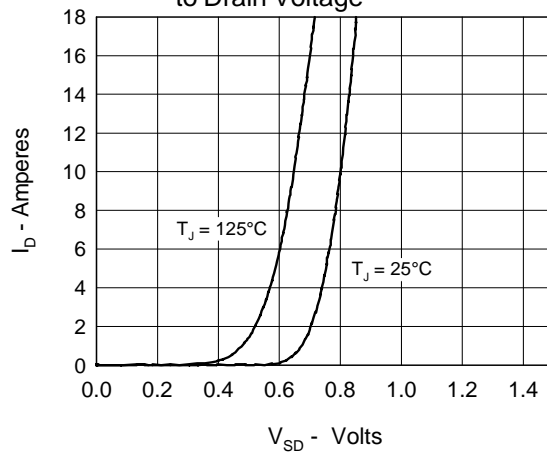
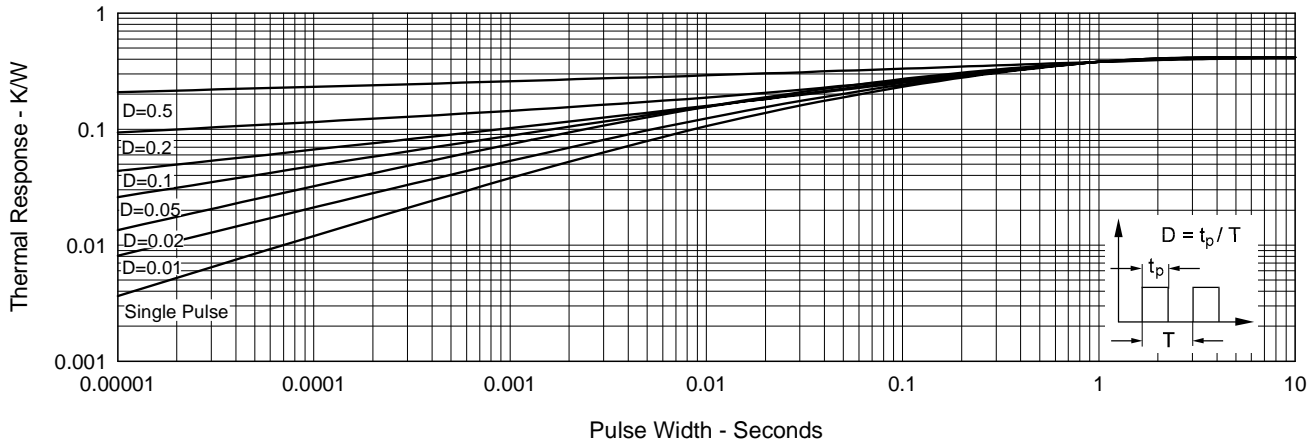

Fig.10. Transient Thermal Impedance



IXYS reserves the right to change limits, test conditions, and dimensions.