

HiPerFET™

Power MOSFET

Q-Class

IXFP4N100QM

$$V_{DSS} = 1000V$$

$$I_{D25} = 2.2A$$

$$R_{DS(on)} \leq 3.0\Omega$$

N-Channel Enhancement Mode
 Avalanche Rated, Low Q_g , High dv/dt
 Fast Intrinsic Diode

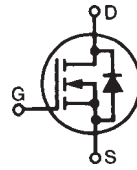

Symbol	Test Conditions	Maximum Ratings	
V_{DSS}	$T_J = 25^\circ C$ to $150^\circ C$	1000	V
V_{DGR}	$T_J = 25^\circ C$ to $150^\circ C$, $R_{GS} = 1M\Omega$	1000	V
V_{GSS}	Continuous	± 20	V
V_{GSM}	Transient	± 30	V
I_{D25}	$T_C = 25^\circ C$	2.2	A
I_{DM}	$T_C = 25^\circ C$, pulse width limited by T_{JM}	16	A
I_A	$T_C = 25^\circ C$	4	A
E_{AS}	$T_C = 25^\circ C$	700	mJ
dv/dt	$I_S \leq I_{DM}$, $V_{DD} \leq V_{DSS}$, $T_J \leq 150^\circ C$	5	V/ns
P_D	$T_C = 25^\circ C$	46	W
T_J		- 55 ... +150	$^\circ C$
T_{JM}		150	$^\circ C$
T_{stg}		- 55 ... +150	$^\circ C$
T_L	1.6mm (0.062 in.) from case for 10s	300	$^\circ C$
T_{SOLD}	Plastic body for 10s	260	$^\circ C$
M_d	Mounting Torque	1.13 / 10	Nm/lb.in.
Weight		2.5	g

OVERMOLDED (IXFP...M) OUTLINE

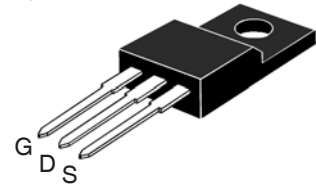

G = Gate D = Drain
 S = Source

Features

- Plastic Overmolded Tab for Electrical Isolation
- International Standard Package
- Avalanche Rated
- Fast Intrinsic Diode
- Molding Epoxies meet UL 94 V-0 Flammability Classification

Advantages

- High Power Density
- Easy to Mount
- Space Savings

Symbol	Test Conditions ($T_J = 25^\circ C$, Unless Otherwise Specified)	Characteristic Values		
		Min.	Typ.	Max.
BV_{DSS}	$V_{GS} = 0V$, $I_D = 1mA$	1000		V
$V_{GS(th)}$	$V_{DS} = V_{GS}$, $I_D = 1.5mA$	3.0		5.0 V
I_{GSS}	$V_{GS} = \pm 20V$, $V_{DS} = 0V$			± 100 nA
I_{DSS}	$V_{DS} = V_{DSS}$, $V_{GS} = 0V$ $T_J = 125^\circ C$			25 μA 1 mA
$R_{DS(on)}$	$V_{GS} = 10V$, $I_D = 2A$, Note 1			3.0 Ω

Symbol	Test Conditions ($T_J = 25^\circ\text{C}$, Unless Otherwise Specified)	Characteristic Values		
		Min.	Typ.	Max.
g_{fs}	$V_{DS} = 20\text{V}, I_D = 2\text{A}$, Note 1	2.5	4.3	S
C_{iss}	$V_{GS} = 0\text{V}, V_{DS} = 25\text{V}, f = 1\text{MHz}$		1185	pF
C_{oss}			130	pF
C_{rss}			65	pF
$t_{d(on)}$	Resistive Switching Times $V_{GS} = 10\text{V}, V_{DS} = 0.5 \cdot V_{DSS}, I_D = 2\text{A}$, $R_G = 4.7\Omega$ (External)		17	ns
t_r			15	ns
$t_{d(off)}$			32	ns
t_f			18	ns
$Q_{g(on)}$	$V_{GS} = 10\text{V}, V_{DS} = 0.5 \cdot V_{DSS}, I_D = 2\text{A}$		43.5	nC
Q_{gs}			6.2	nC
Q_{gd}			23.0	nC
R_{thJC}				2.7 °C/W

Source-Drain Diode

Symbol	Test Conditions ($T_J = 25^\circ\text{C}$, Unless Otherwise Specified)	Characteristic Values		
		Min.	Typ.	Max.
I_S	$V_{GS} = 0\text{V}$			4 A
I_{SM}	Repetitive, Pulse Width Limited by T_{JM}			16 A
V_{SD}	$I_F = I_S, V_{GS} = 0\text{V}$, Note 1			1.5 V
t_{rr}	$I_F = 4\text{A}, -di/dt = 100\text{A}/\mu\text{s}$, $V_R = 100\text{V}, V_{GS} = 0\text{V}$		250	ns
Q_{RM}				nC
I_{RM}				A
			480	
			6.16	

Note 1. Pulse test, $t \leq 300\mu\text{s}$; duty cycle, $d \leq 2\%$.

OVERMOLDED TO-220 (IXFP...M)

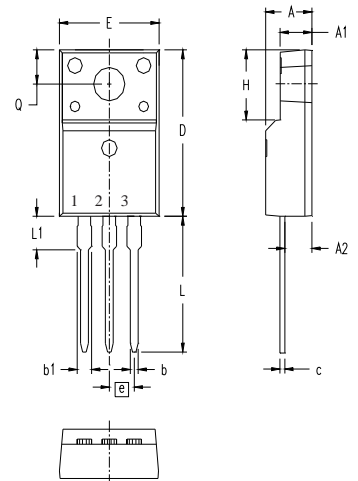

Terminals: 1 - Gate
2 - Drain (Collector)
3 - Source (Emitter)

SYM	INCHES		MILLIMETERS	
	MIN	MAX	MIN	MAX
A	.177	.193	4.50	4.90
A1	.092	.108	2.34	2.74
A2	.101	.117	2.56	2.96
b	.028	.035	0.70	0.90
b1	.050	.058	1.27	1.47
c	.018	.024	0.45	0.60
D	.617	.633	15.67	16.07
E	.392	.408	9.96	10.36
e	.100 BSC		2.54 BSC	
H	.255	.271	6.48	6.88
L	.499	.523	12.68	13.28
L1	.119	.135	3.03	3.43
$\varnothing P$.121	.129	3.08	3.28
Q	.126	.134	3.20	3.40

ADVANCE TECHNICAL INFORMATION

The product presented herein is under development. The Technical Specifications offered are derived from a subjective evaluation of the design, based upon prior knowledge and experience, and constitute a "considered reflection" of the anticipated result. IXYS reserves the right to change limits, test conditions, and dimensions without notice.

IXYS Reserves the Right to Change Limits, Test Conditions, and Dimensions.

IXYS MOSFETs and IGBTs are covered by one or more of the following U.S. patents:	4,835,592	4,931,844	5,049,961	5,237,481	6,162,665	6,404,065 B1	6,683,344	6,727,585	7,005,734 B2	7,157,338B2
	4,850,072	5,017,508	5,063,307	5,381,025	6,259,123 B1	6,534,343	6,710,405 B2	6,759,692	7,063,975 B2	
	4,881,106	5,034,796	5,187,117	5,486,715	6,306,728 B1	6,583,505	6,710,463	6,771,478 B2	7,071,537	

Fig. 1. Output Characteristics @ 25°C

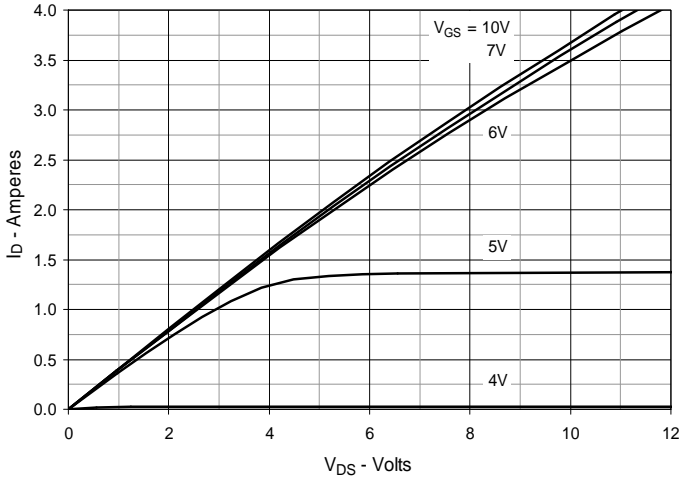

Fig. 2. Extended Output Characteristics @ 25°C

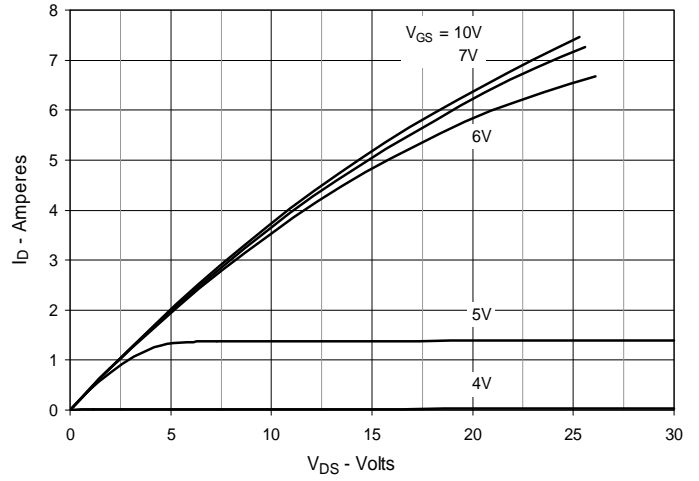

Fig. 3. Output Characteristics @ 125°C

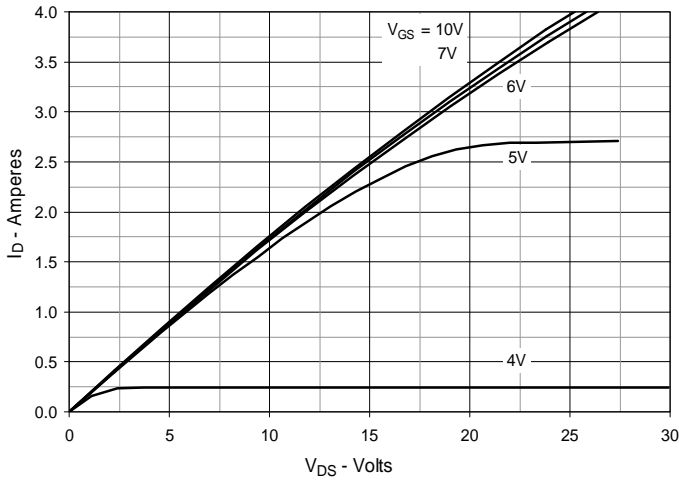

Fig. 4. $R_{DS(on)}$ Normalized to $I_D = 2A$ Value vs. Junction Temperature

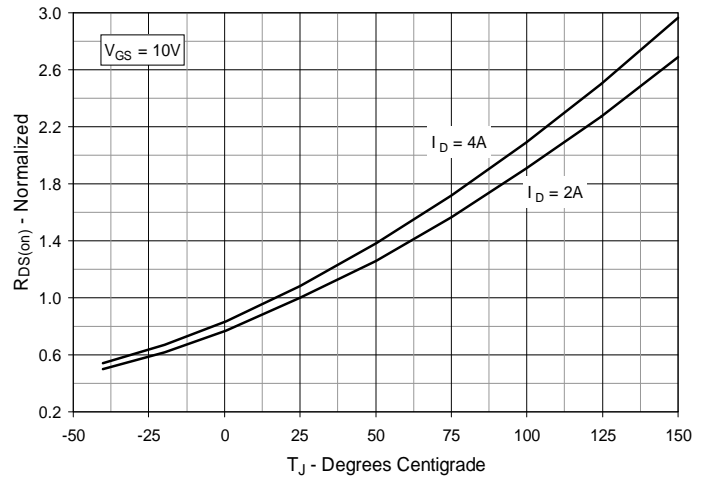

Fig. 5. $R_{DS(on)}$ Normalized to $I_D = 2A$ Value vs. Drain Current

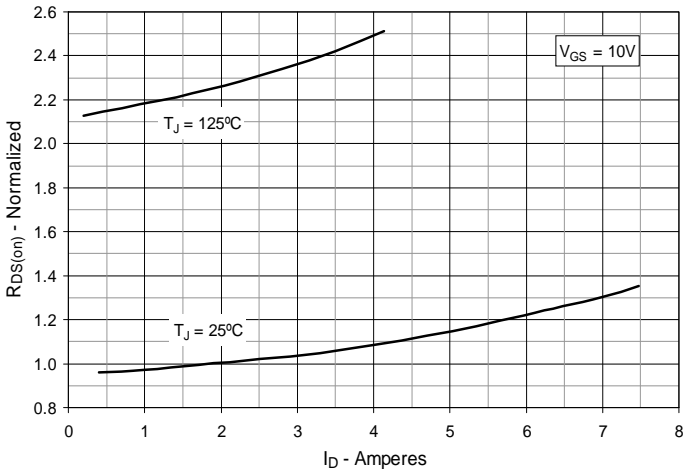

Fig. 6. Maximum Drain Current vs. Case Temperature

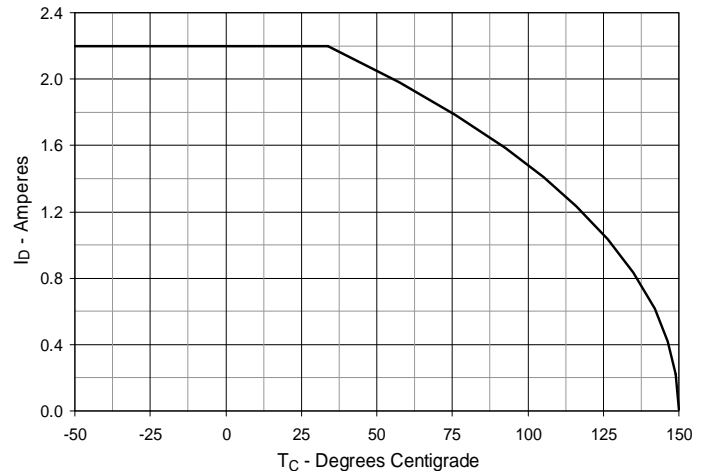

Fig. 7. Input Admittance

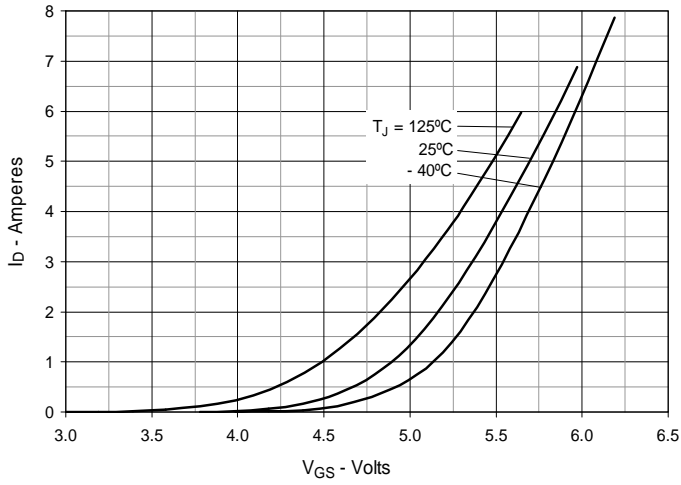

Fig. 8. Transconductance

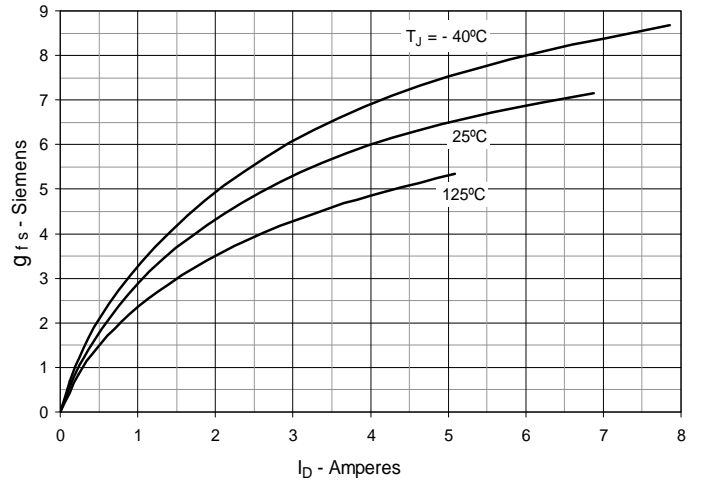

Fig. 9. Forward Voltage Drop of Intrinsic Diode

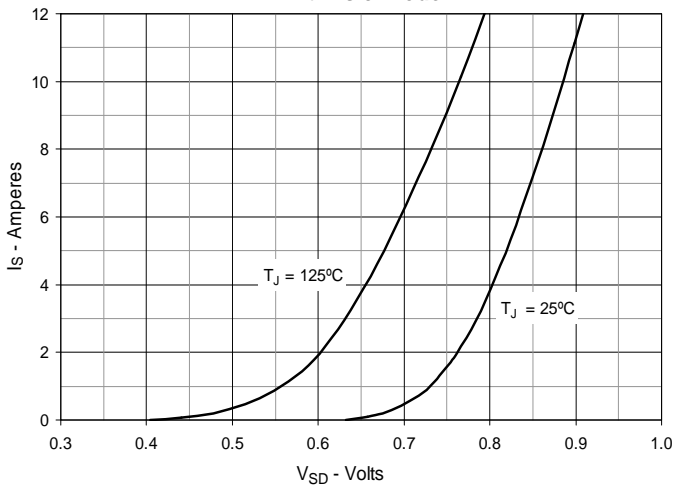

Fig. 10. Gate Charge

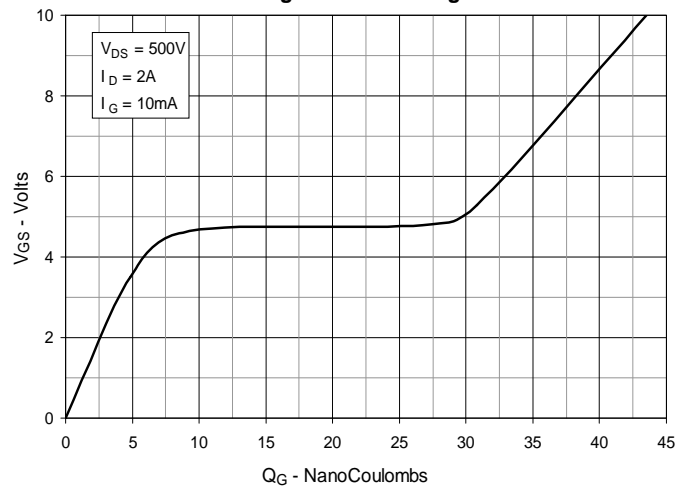

Fig. 11. Capacitance

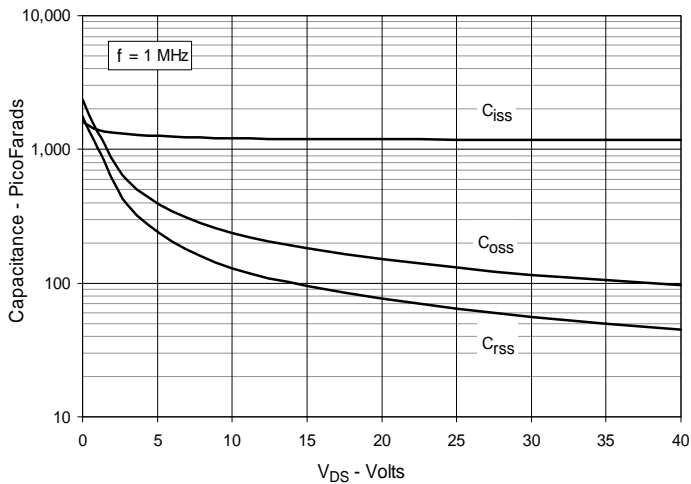

Fig. 12. Maximum Transient Thermal Impedance

