

PolarHV™ HiPerFET IXFC 30N60P Power MOSFET IXFR 30N60P

Electrically Isolated Back Surface

N-Channel Enhancement Mode
Fast Recovery Diode
Avalanche Rated

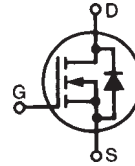

$$\begin{aligned} V_{DSS} &= 600 \text{ V} \\ I_{D25} &= 15 \text{ A} \\ R_{DS(on)} &\leq 250 \text{ m}\Omega \\ t_{rr} &\leq 250 \text{ ns} \end{aligned}$$

Symbol	Test Conditions	Maximum Ratings		
V_{DSS}	$T_J = 25^\circ\text{C}$ to 150°C	600	V	
V_{DGR}	$T_J = 25^\circ\text{C}$ to 150°C ; $R_{GS} = 1 \text{ M}\Omega$	600	V	
V_{GSS}	Continuous	± 30	V	
V_{GSM}	Transient	± 40	V	
I_{D25}	$T_C = 25^\circ\text{C}$	15	A	
I_{DM}	$T_C = 25^\circ\text{C}$, pulse width limited by T_{JM}	80	A	
I_{AR}	$T_C = 25^\circ\text{C}$	30	A	
E_{AR}	$T_C = 25^\circ\text{C}$	50	mJ	
E_{AS}	$T_C = 25^\circ\text{C}$	1.5	J	
dv/dt	$I_S \leq I_{DM}$, $di/dt \leq 100 \text{ A}/\mu\text{s}$, $V_{DD} \leq V_{DSS}$, $T_J \leq 150^\circ\text{C}$, $R_G = 3 \Omega$	10	V/ns	
P_D	$T_C = 25^\circ\text{C}$	166	W	
T_J		-55 ... +150	$^\circ\text{C}$	
T_{JM}		150	$^\circ\text{C}$	
T_{stg}		-55 ... +150	$^\circ\text{C}$	
T_L	1.6 mm (0.062 in.) from case for 10 s	300	$^\circ\text{C}$	
V_{ISOL}	50/60 Hz, RMS, $t = 1$ minute, leads-to-tab	2500	V~	
F_C	Mounting Force	(IXFC)	11..65 / 2.5..15	N/lb
		(IXFR)	20..120 / 4.5..25	N/lb
Weight	ISOPLUS220	2	g	
	ISOPLUS247	5	g	

ISOPLUS220™ (IXFC)
E153432

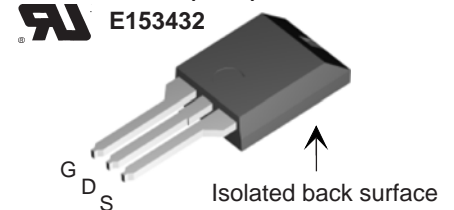

ISOPLUS247™ (IXFR)
E153432

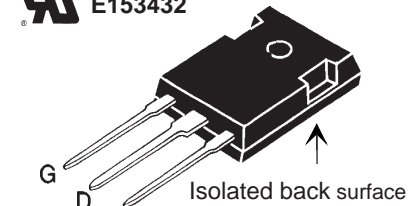

G = Gate
S = Source
D = Drain

Features

- Silicon chip on Direct-Copper-Bond substrate
- High power dissipation
- Isolated mounting surface
- 2500V electrical isolation
- Low drain to tab capacitance (<30pF)

Applications

- DC-DC converters
- Battery chargers
- Switched-mode and resonant-mode power supplies
- DC choppers
- AC motor control

Advantages

- Easy assembly
- Space savings
- High power density

Symbol	Test Conditions ($T_J = 25^\circ\text{C}$, unless otherwise specified)	Characteristic Values		
		Min.	Typ.	Max.
BV_{DSS}	$V_{GS} = 0 \text{ V}$, $I_D = 250 \mu\text{A}$	600		V
$V_{GS(th)}$	$V_{DS} = V_{GS}$, $I_D = 4 \text{ mA}$	3.0		5.0 V
I_{GSS}	$V_{GS} = \pm 30 \text{ V}$, $V_{DS} = 0$			$\pm 100 \text{ nA}$
I_{DSS}	$V_{DS} = V_{DSS}$ $V_{GS} = 0 \text{ V}$ $T_J = 125^\circ\text{C}$			25 μA
				500 μA
$R_{DS(on)}$	$V_{GS} = 10 \text{ V}$, $I_D = 15 \text{ A}$ Pulse test, $t \leq 300 \mu\text{s}$, duty cycle $d \leq 2\%$			250 $\text{m}\Omega$

Symbol	Test Conditions	Characteristic Values ($T_J = 25^\circ\text{C}$ unless otherwise specified)		
		Min.	Typ.	Max.
g_{fs}	$V_{DS} = 20\text{ V}; I_D = 15\text{ A}$, pulse test	15	27	S
C_{iss}	$V_{GS} = 0\text{ V}, V_{DS} = 25\text{ V}, f = 1\text{ MHz}$		3820	pF
C_{oss}			360	pF
C_{rss}			28	pF
$t_{d(on)}$	$V_{GS} = 10\text{ V}, V_{DS} = V_{DSS}, I_D = 15\text{ A}$ $R_G = 3\ \Omega$ (External)		22	ns
t_r			20	ns
$t_{d(off)}$			75	ns
t_f			25	ns
$Q_{g(on)}$	$V_{GS} = 10\text{ V}, V_{DS} = 0.5 V_{DSS}, I_D = 15\text{ A}$		85	nC
Q_{gs}			26	nC
Q_{gd}			28	nC
R_{thJC}			0.75	$^\circ\text{C/W}$
R_{thCS}		0.21		$^\circ\text{C/W}$

Symbol	Test Conditions	Characteristic Values ($T_J = 25^\circ\text{C}$ unless otherwise specified)		
		Min.	Typ.	Max.
I_S	$V_{GS} = 0\text{ V}$			30 A
I_{SM}	Repetitive			80 A
V_{SD}	$I_F = I_S, V_{GS} = 0\text{ V}$, Pulse test, $t \leq 300\ \mu\text{s}$, duty cycle $d \leq 2\%$			1.5 V
t_{rr}	$I_F = 25\text{ A}, -di/dt = 100\text{ A}/\mu\text{s}$ $V_R = 100\text{ V}; V_{GS} = 0\text{ V}$			200 ns
I_{RM}			8	A
Q_{RM}			0.6	μC

ISOPLUS220 (IXFC) Outline

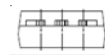
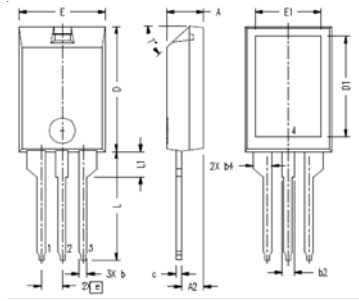

Note:
Bottom heatsink (Pin 4) is electrically isolated from Pin 1, 2, or 3.

SYM	INCHES		MILLIMETERS	
	MIN	MAX	MIN	MAX
A	.157	.197	4.00	5.00
A2	.098	.118	2.50	3.00
b	.035	.051	0.90	1.30
b2	.049	.065	1.25	1.65
b4	.093	.100	2.35	2.55
c	.028	.039	0.70	1.00
D	.591	.630	15.00	16.00
D1	.472	.512	12.00	13.00
E	.394	.433	10.00	11.00
E1	.295	.335	7.50	8.50
e	.100 BASIC		2.55 BASIC	
L	.512	.571	13.00	14.50
L1	.118	.138	3.00	3.50
T*			42.5*	47.5*

IXYS CO 0177 R0

ISOPLUS247 (IXFR) Outline

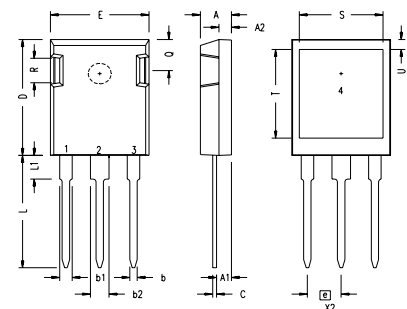

SYM	INCHES		MILLIMETERS	
	MIN	MAX	MIN	MAX
A	.190	.205	4.83	5.21
A1	.090	.100	2.29	2.54
A2	.075	.085	1.91	2.16
b	.045	.055	1.14	1.40
b1	.075	.084	1.91	2.13
b2	.115	.123	2.92	3.12
C	.024	.031	0.61	0.80
D	.819	.840	20.80	21.34
E	.620	.635	15.75	16.13
e	.215 BSC		5.45 BSC	
L	.780	.800	19.81	20.32
L1	.150	.170	3.81	4.32
Q	.220	.244	5.59	6.20
R	.170	.190	4.32	4.83
S	.520	.540	13.21	13.72
T	.620	.640	15.75	16.26
U	.065	.080	1.65	2.03

- 1 - GATE
- 2 - DRAIN (COLLECTOR)
- 3 - SOURCE (EMITTER)
- 4 - NO CONNECTION

NOTE: This drawing will meet all dimensions requirement of JEDEC outline TO-247AD except screw hole.

IXYS reserves the right to change limits, test conditions, and dimensions.

IXYS MOSFETs and IGBTs are covered by one or more of the following U.S. patents:	4,835,592	4,931,844	5,049,961	5,237,481	6,162,665	6,404,065 B1	6,683,344	6,727,585
	4,850,072	5,017,508	5,063,307	5,381,025	6,259,123 B1	6,534,343	6,710,405B2	6,759,692
	4,881,106	5,034,796	5,187,117	5,486,715	6,306,728 B1	6,583,505	6,710,463	6,771,478 B2

Fig. 1. Output Characteristics
@ 25°C

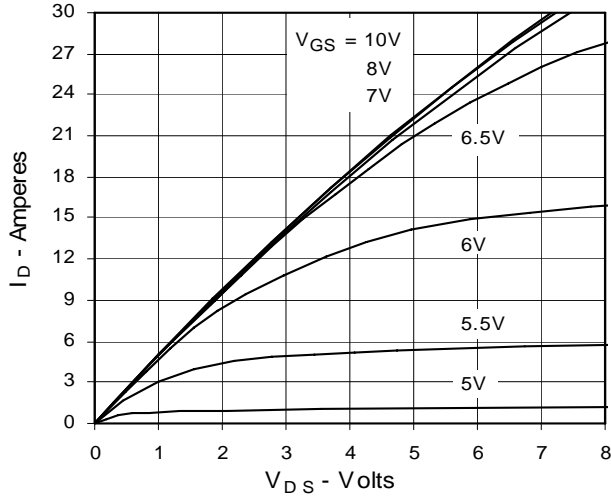

Fig. 2. Extended Output Characteristics
@ 25°C

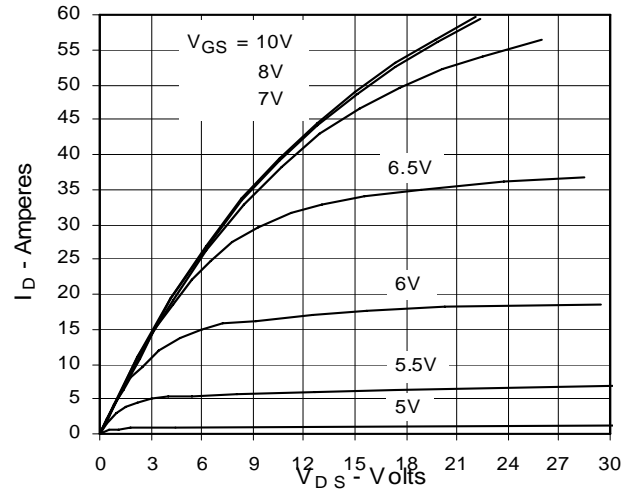

Fig. 3. Output Characteristics
@ 125°C

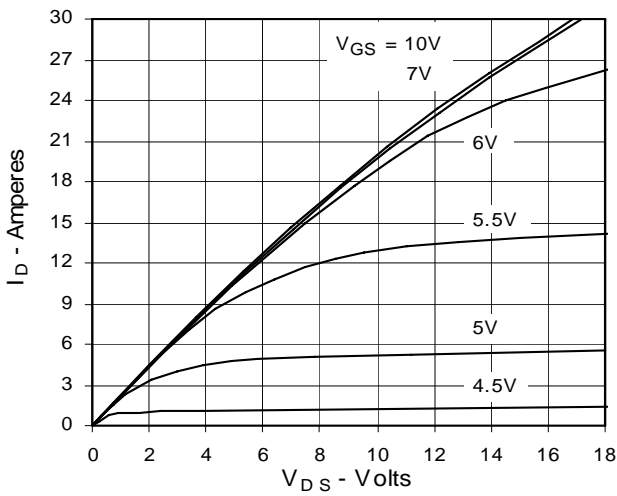

Fig. 4. $R_{DS(on)}$ Normalized to $I_D = 15A$ Value vs. Junction Temperature

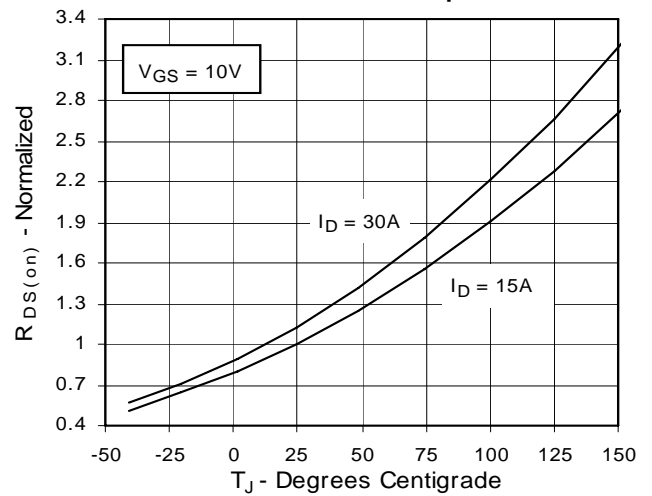

Fig. 5. $R_{DS(on)}$ Normalized to $I_D = 15A$ Value vs. Drain Current

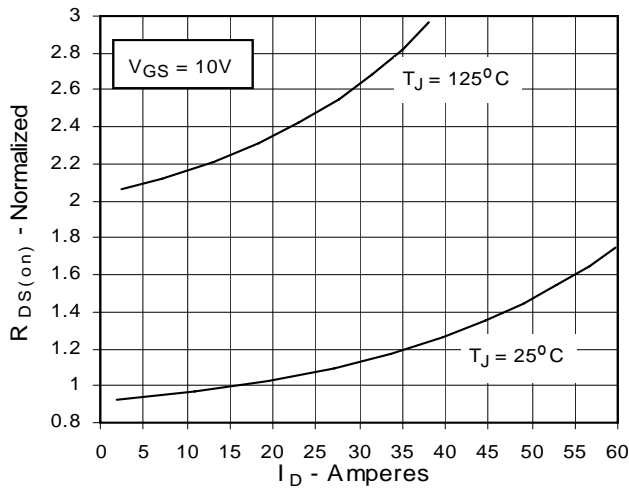

Fig. 6. Drain Current vs. Case Temperature

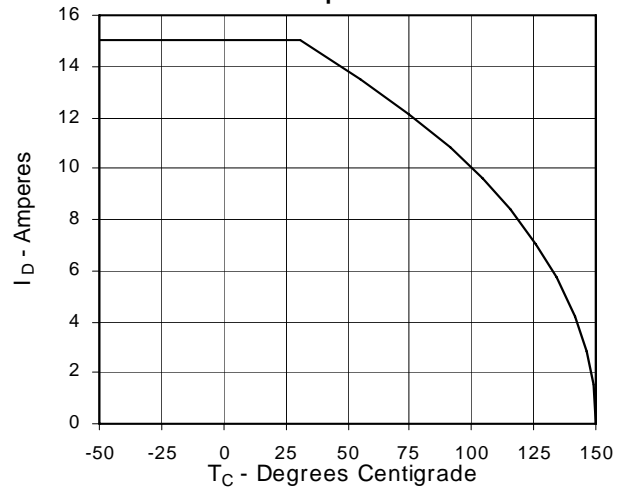

Fig. 7. Input Admittance

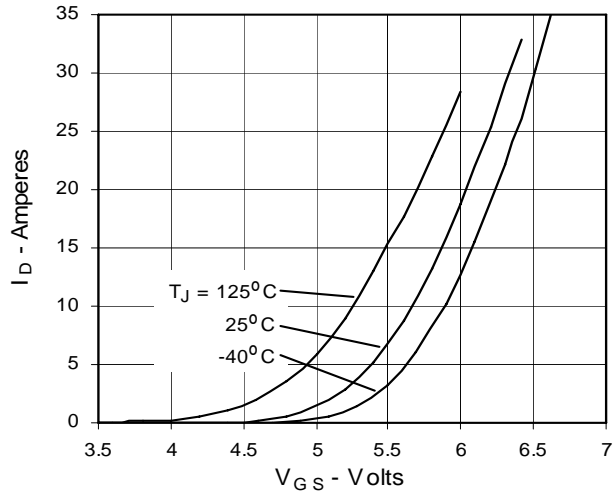

Fig. 8. Transconductance

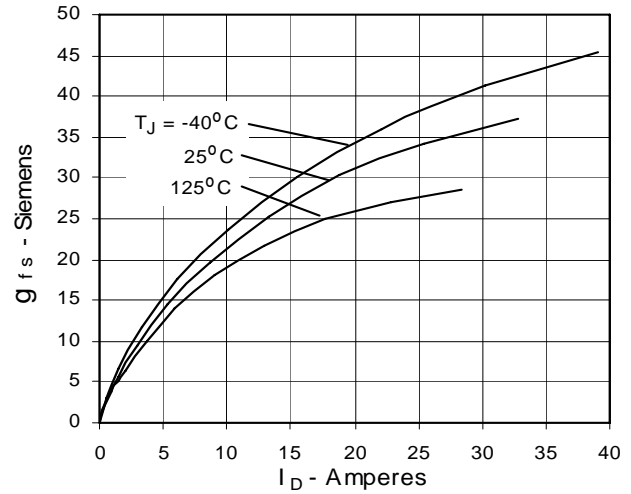

Fig. 9. Source Current vs. Source-To-Drain Voltage

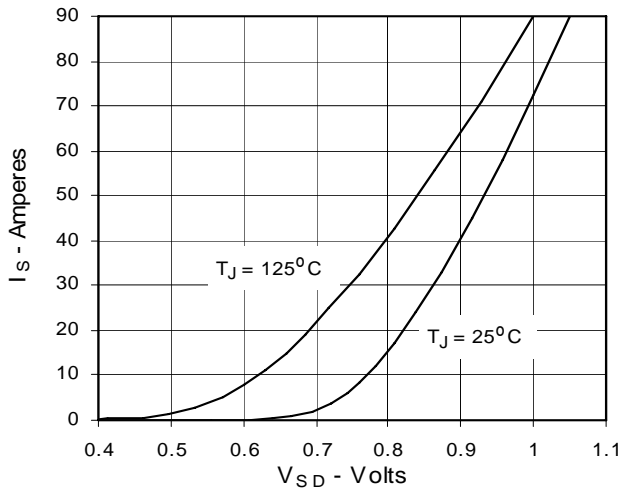

Fig. 10. Gate Charge

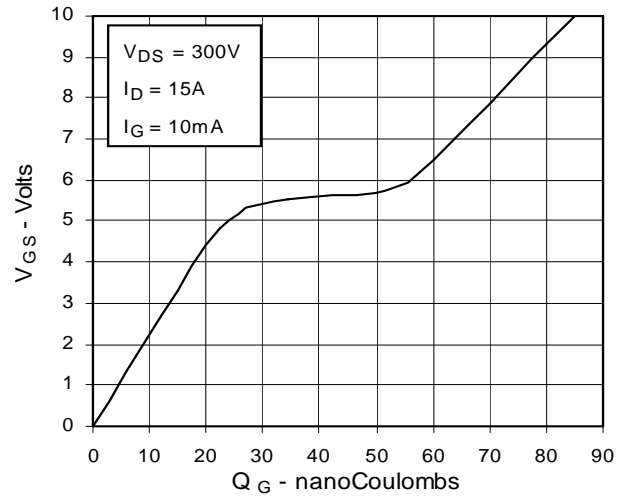

Fig. 11. Capacitance

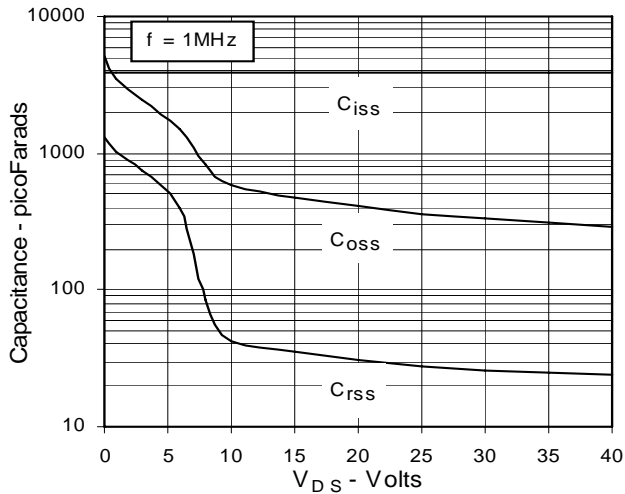

Fig. 12. Maximum Transient Thermal Resistance

