

# PolarHV™ HiPerFET IXFR 36N60P

## Power MOSFET

(Electrically Isolated Back Surface)

N-Channel Enhancement Mode  
Avalanche Rated  
Fast Intrinsic Diode

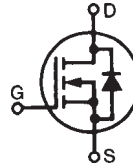

$V_{DSS}$	=	600	V
$I_{D25}$	=	20	A
$R_{DS(on)}$	≤	200	mΩ
$t_{rr}$	≤	200	ns

Symbol	Test Conditions	Maximum Ratings	
$V_{DSS}$	$T_J = 25^\circ\text{C}$ to $150^\circ\text{C}$	600	V
$V_{DGR}$	$T_J = 25^\circ\text{C}$ to $150^\circ\text{C}$ ; $R_{GS} = 1\text{ M}\Omega$	600	V
$V_{GSS}$	Continuous	±30	V
$V_{GSM}$	Transient	±40	V
$I_{D25}$	$T_C = 25^\circ\text{C}$	20	A
$I_{DM}$	$T_C = 25^\circ\text{C}$ , pulse width limited by $T_{JM}$	80	A
$I_{AR}$	$T_C = 25^\circ\text{C}$	36	A
$E_{AR}$	$T_C = 25^\circ\text{C}$	50	mJ
$E_{AS}$	$T_C = 25^\circ\text{C}$	1.5	J
$dv/dt$	$I_S \leq I_{DM}$ , $di/dt \leq 100\text{ A}/\mu\text{s}$ , $V_{DD} \leq V_{DSS}$ , $T_J \leq 150^\circ\text{C}$ , $R_G = 2\ \Omega$	20	V/ns
$P_D$	$T_C = 25^\circ\text{C}$	208	°C
$T_J$		-55 ... +150	°C
$T_{JM}$		150	°C
$T_{stg}$		-55 ... +150	°C
$T_L$	1.6 mm (0.062 in.) from case for 10 s	300	°C
$T_{SOLD}$	Plastic body for 10 s	260	°C
$V_{ISOL}$	50/60 Hz, RMS, 1 minute	2500	V~
$F_C$	Mounting force	20..120/4.6..27	N/lb
<b>Weight</b>		5	g

ISOPLUS247 (IXFR)  
E153432

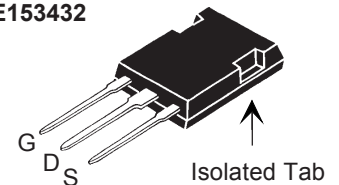

G = Gate    D = Drain  
S = Source

### Features

- † Silicon chip on Direct-Copper-Bond substrate
  - High power dissipation
  - Isolated mounting surface
  - 2500V electrical isolation
- † International standard package
- † Fast recovery diode
- † Unclamped Inductive Switching (UIS) rated
- † Low package inductance
  - easy to drive and to protect

Symbol	Test Conditions	Characteristic Values		
		Min.	Typ.	Max.
$BV_{DSS}$	$V_{GS} = 0\text{ V}$ , $I_D = 250\ \mu\text{A}$	600		V
$V_{GS(th)}$	$V_{DS} = V_{GS}$ , $I_D = 4\text{ mA}$	3.0		5.0 V
$I_{GSS}$	$V_{GS} = \pm 30\text{ V}$ , $V_{DS} = 0\text{ V}$			±100 nA
$I_{DSS}$	$V_{DS} = V_{DSS}$ $V_{GS} = 0\text{ V}$ $T_J = 125^\circ\text{C}$			25 $\mu\text{A}$ 250 $\mu\text{A}$
$R_{DS(on)}$	$V_{GS} = 10\text{ V}$ , $I_D = I_T$ (note 1) Pulse test, $t \leq 300\ \mu\text{s}$ , duty cycle $d \leq 2\%$			200 mΩ

### Advantages

- † Easy to mount
- † Space savings
- † High power density

Symbol	Test Conditions	Characteristic Values ( $T_J = 25^\circ\text{C}$ , unless otherwise specified)		
		Min.	Typ.	Max.
$g_{fs}$	$V_{DS} = 20\text{ V}; I_D = I_T$ , pulse test	25	40	S
$C_{iss}$	$V_{GS} = 0\text{ V}, V_{DS} = 25\text{ V}, f = 1\text{ MHz}$		5800	pF
$C_{oss}$			570	pF
$C_{rss}$			30	pF
$t_{d(on)}$	$V_{GS} = 10\text{ V}, V_{DS} = 0.5 V_{DSS}, I_D = I_T$ $R_G = 2\ \Omega$ (External)		30	ns
$t_r$			25	ns
$t_{d(off)}$			80	ns
$t_f$			22	ns
$Q_{g(on)}$	$V_{GS} = 10\text{ V}, V_{DS} = 0.5 V_{DSS}, I_D = I_T$		102	nC
$Q_{gs}$			34	nC
$Q_{gd}$			36	nC
$R_{thJC}$			0.6	$^\circ\text{C/W}$
$R_{thCS}$		0.15		$^\circ\text{C/W}$

Note 1: Test current  $I_T = 18\text{ A}$

### Source-Drain Diode

Symbol	Test Conditions	Characteristic Values ( $T_J = 25^\circ\text{C}$ , unless otherwise specified)		
		Min.	Typ.	Max.
$I_S$	$V_{GS} = 0\text{ V}$			36 A
$I_{SM}$	Repetitive			80 A
$V_{SD}$	$I_F = I_S, V_{GS} = 0\text{ V}$ , Pulse test, $t \leq 300\ \mu\text{s}$ , duty cycle $d \leq 2\%$			1.5 V
$t_{rr}$	$I_F = 25\text{ A}, -di/dt = 100\text{ A}/\mu\text{s}$ $V_R = 100\text{ V}, V_{GS} = 0\text{ V}$			200 ns
$Q_{RM}$			0.8	$\mu\text{C}$
$I_{RM}$			6.0	A

### ISOPLUS247 (IXFR) Outline

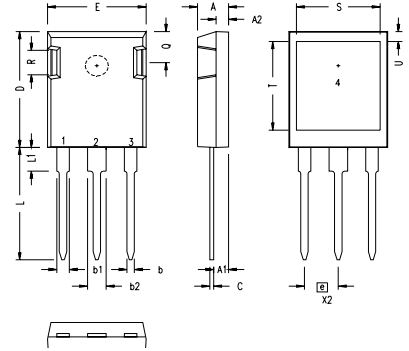

SYM	INCHES		MILLIMETERS	
	MIN	MAX	MIN	MAX
A	.190	.205	4.83	5.21
A1	.090	.100	2.29	2.54
A2	.075	.085	1.91	2.16
b	.045	.055	1.14	1.40
b1	.075	.084	1.91	2.13
b2	.115	.123	2.92	3.12
C	.024	.031	0.61	0.80
D	.819	.840	20.80	21.34
E	.620	.635	15.75	16.13
e	.215 BSC		5.45 BSC	
L	.780	.800	19.81	20.32
L1	.150	.170	3.81	4.32
Q	.220	.244	5.59	6.20
R	.170	.190	4.32	4.83
S	.520	.540	13.21	13.72
T	.620	.640	15.75	16.26
U	.065	.080	1.65	2.03

- 1 - GATE
- 2 - DRAIN (COLLECTOR)
- 3 - SOURCE (EMITTER)
- 4 - NO CONNECTION

NOTE: This drawing will meet all dimensions requirement of JEDEC outline TO-247AD except screw hole.

IXYS reserves the right to change limits, test conditions, and dimensions.

IXYS MOSFETs and IGBTs are covered by 4,835,592 4,931,844 5,049,961 5,237,481 6,162,665 6,404,065 B1 6,683,344 6,727,585  
one or more of the following U.S. patents: 4,850,072 5,017,508 5,063,307 5,381,025 6,259,123 B1 6,534,343 6,710,405B2 6,759,692  
4,881,106 5,034,796 5,187,117 5,486,715 6,306,728 B1 6,583,505 6,710,463 6,771,478 B2

**Fig. 1. Output Characteristics @ 25°C**

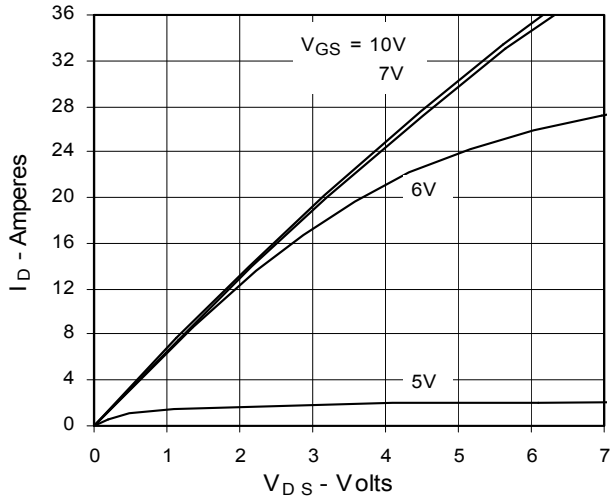

**Fig. 2. Extended Output Characteristics @ 25°C**

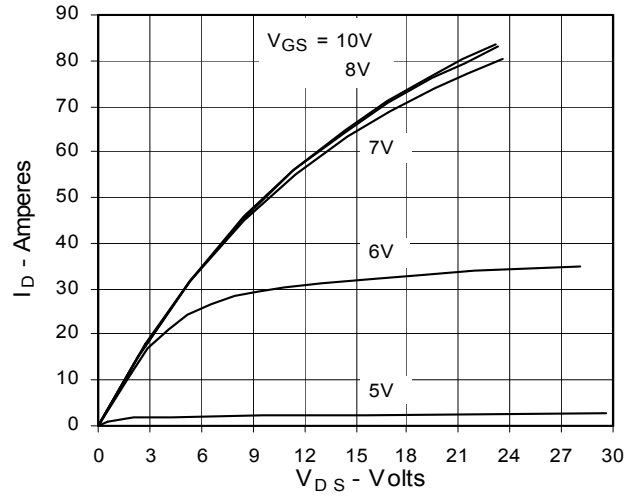

**Fig. 3. Output Characteristics @ 125°C**

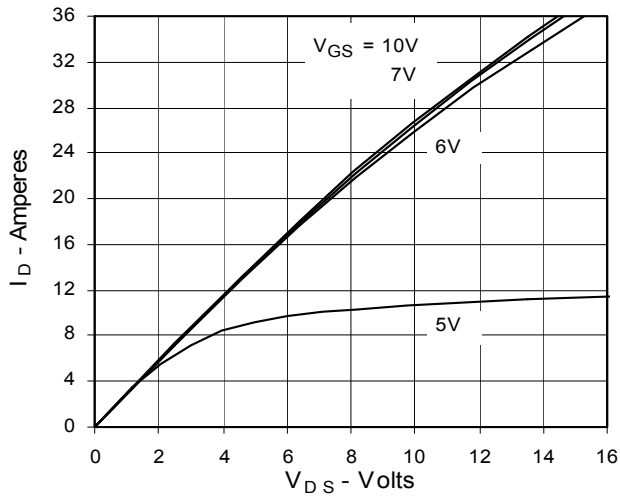

**Fig. 4.  $R_{DS(on)}$  Normalized to  $I_D = 18A$  Value vs. Junction Temperature**

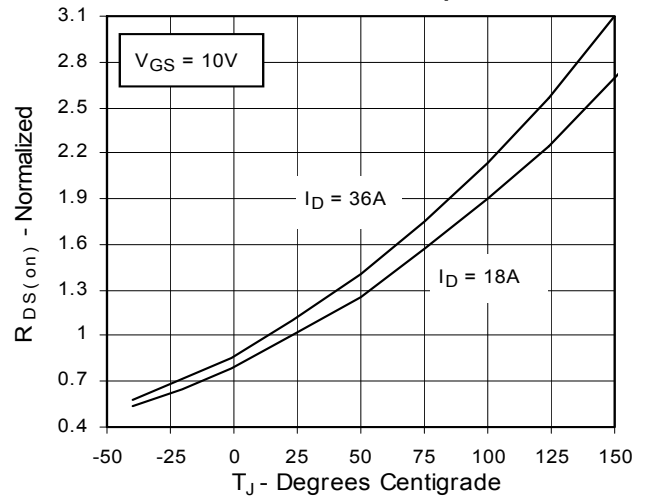

**Fig. 5.  $R_{DS(on)}$  Normalized to  $I_D = 18A$  Value vs.  $I_D$**

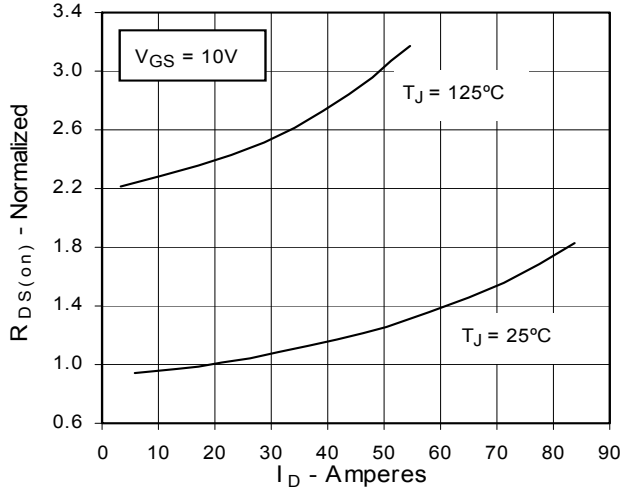

**Fig. 6. Drain Current vs. Case Temperature**

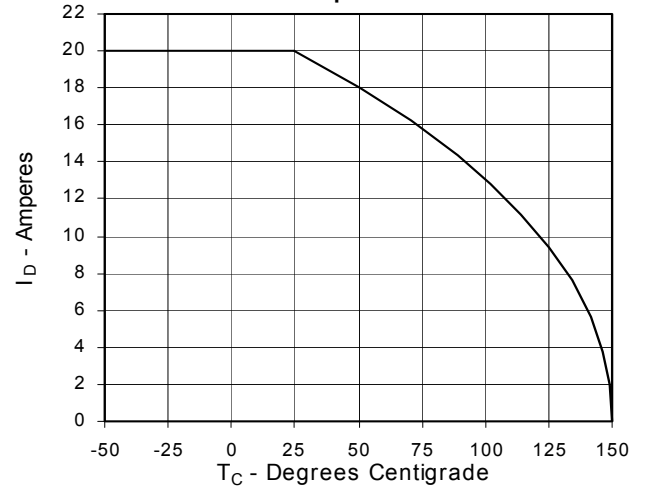

**Fig. 7. Input Admittance**

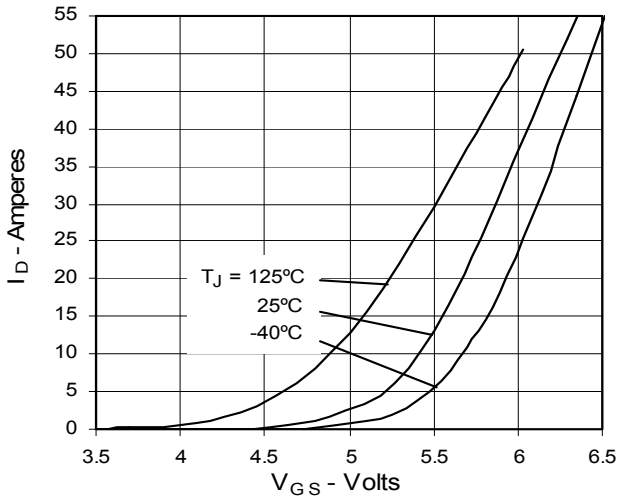

**Fig. 8. Transconductance**

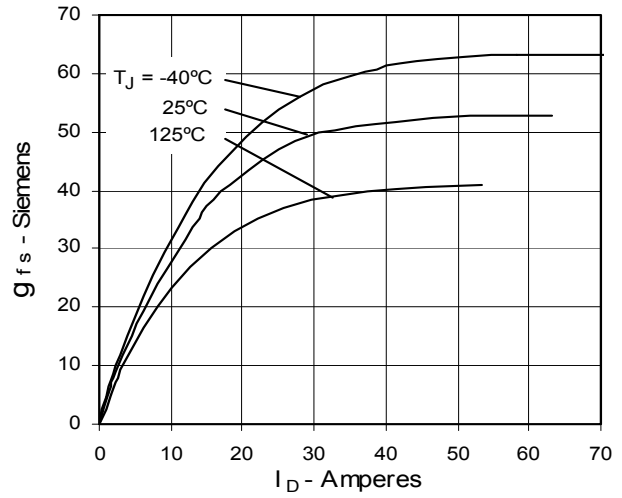

**Fig. 9. Source Current vs. Source-To-Drain Voltage**

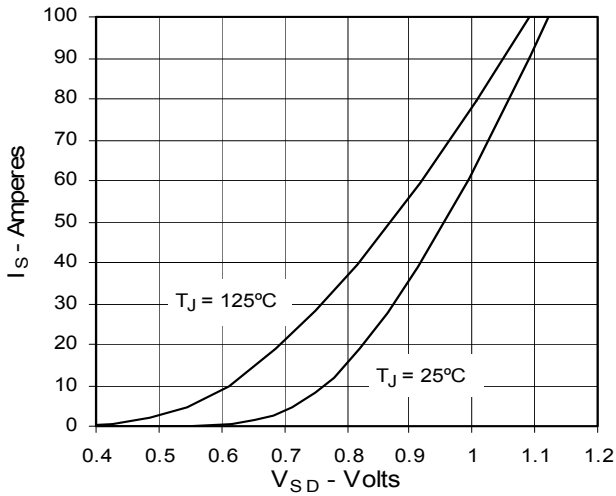

**Fig. 10. Gate Charge**

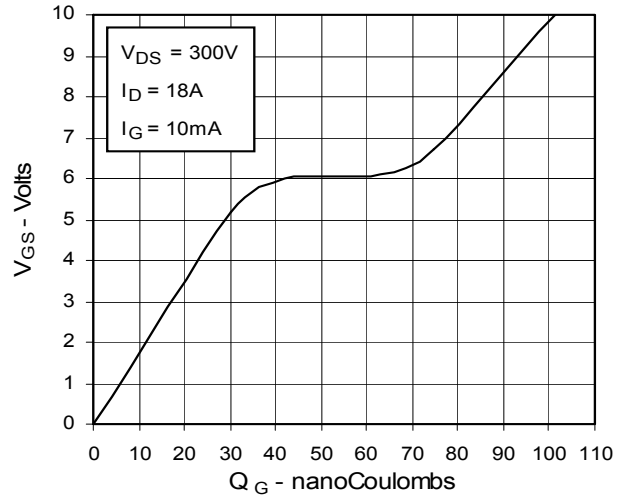

**Fig. 11. Capacitance**

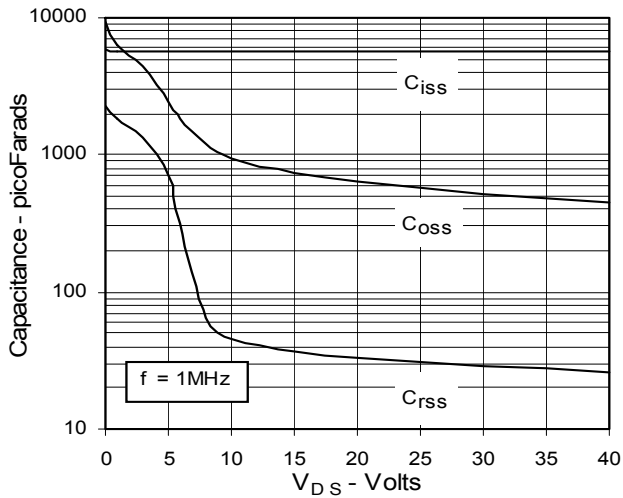

**Fig. 12. Maximum Transient Thermal Resistance**

