

**Polar™ HiPerFET™**  
**Power MOSFET**

**IXFH69N30P**  
**IXFT69N30P**

$V_{DSS} = 300V$   
 $I_{D25} = 69A$   
 $R_{DS(on)} \leq 49m\Omega$   
 $t_{rr} \leq 200ns$

N-Channel Enhancement Mode  
Avalanche Rated  
Fast Intrinsic Diode

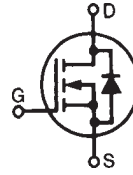

TO-247 (IXFH)

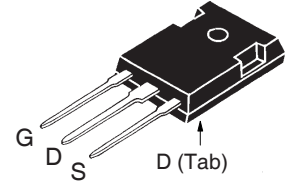

TO-268 (IXFT)

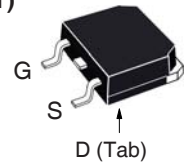

G = Gate      D = Drain  
S = Source    Tab = Drain

Symbol	Test Conditions	Maximum Ratings	
$V_{DSS}$	$T_J = 25^\circ C$ to $150^\circ C$	300	V
$V_{DGR}$	$T_J = 25^\circ C$ to $150^\circ C$ , $R_{GS} = 1M\Omega$	300	V
$V_{GSS}$	Continuous	$\pm 20$	V
$V_{GSM}$	Transient	$\pm 30$	V
$I_{D25}$	$T_C = 25^\circ C$	69	A
$I_{DM}$	$T_C = 25^\circ C$ , Pulse Width Limited by $T_{JM}$	200	A
$I_A$	$T_C = 25^\circ C$	69	A
$E_{AS}$	$T_C = 25^\circ C$	1.5	J
$dV/dt$	$I_S \leq I_{DM}$ , $V_{DD} \leq V_{DSS}$ , $T_J \leq 150^\circ C$	20	V/ns
$P_D$	$T_C = 25^\circ C$	500	W
$T_J$		-55 to +150	$^\circ C$
$T_{JM}$		+150	$^\circ C$
$T_{stg}$		-55 to +150	$^\circ C$
$T_L$	1.6mm (0.063in) from Case for 10s	300	$^\circ C$
$T_{SOLD}$	Plastic Body for 10s	260	$^\circ C$
$M_d$	Mounting Torque (TO-247)	1.13/10	Nm/lb.in.
Weight	TO-247	6	g
	TO-268	4	g

**Features**

- International Standard Packages
- Fast Intrinsic Diode
- Avalanche Rated
- Low  $R_{DS(ON)}$  and  $Q_G$
- Low Package Inductance

**Advantages**

- High Power Density
- Easy to Mount
- Space Savings

**Applications**

- DC-DC Converters
- Battery Chargers
- Switch-Mode and Resonant-Mode Power Supplies
- DC Choppers
- AC and DC Motor Drives
- Uninterrupted Power Supplies
- High Speed Power Switching Applications

Symbol	Test Conditions ( $T_J = 25^\circ C$ , Unless Otherwise Specified)	Characteristic Values		
		Min.	Typ.	Max.
$BV_{DSS}$	$V_{GS} = 0V$ , $I_D = 250\mu A$	300		V
$V_{GS(th)}$	$V_{DS} = V_{GS}$ , $I_D = 4mA$	2.5		5.0 V
$I_{GSS}$	$V_{GS} = \pm 20V$ , $V_{DS} = 0V$			$\pm 100$ nA
$I_{DSS}$	$V_{DS} = V_{DSS}$ , $V_{GS} = 0V$ $T_J = 125^\circ C$			25 $\mu A$
				250 $\mu A$
$R_{DS(on)}$	$V_{GS} = 10V$ , $I_D = 0.5 \cdot I_{D25}$ , Note 1			49 m $\Omega$

Symbol	Test Conditions ( $T_J = 25^\circ\text{C}$ , Unless Otherwise Specified)	Characteristic Values		
		Min.	Typ.	Max.
$g_{fs}$	$V_{DS} = 10\text{V}, I_D = 0.5 \cdot I_{D25}, \text{ Note 1}$	30	48	S
$C_{iss}$	$V_{GS} = 0\text{V}, V_{DS} = 25\text{V}, f = 1\text{MHz}$		4960	pF
$C_{oss}$			760	pF
$C_{rss}$			190	pF
$t_{d(on)}$	<b>Resistive Switching Times</b> $V_{GS} = 10\text{V}, V_{DS} = 0.5 \cdot V_{DSS}, I_D = 69\text{A}$ $R_G = 4\Omega$ (External)		25	ns
$t_r$			25	ns
$t_{d(off)}$			75	ns
$t_f$			27	ns
$Q_{g(on)}$	$V_{GS} = 10\text{V}, V_{DS} = 0.5 \cdot V_{DSS}, I_D = 34.5\text{A}$		156	nC
$Q_{gs}$			32	nC
$Q_{gd}$			79	nC
$R_{thJC}$	TO-247			0.25 $^\circ\text{C/W}$
$R_{thCS}$			0.21	$^\circ\text{C/W}$

### Source-Drain Diode

Symbol	Test Conditions ( $T_J = 25^\circ\text{C}$ , Unless Otherwise Specified)	Characteristic Values		
		Min.	Typ.	Max.
$I_S$	$V_{GS} = 0\text{V}$			69 A
$I_{SM}$	Repetitive, Pulse Width Limited by $T_{JM}$			270 A
$V_{SD}$	$I_F = I_S, V_{GS} = 0\text{V}, \text{ Note 1}$			1.5 V
$t_{rr}$	$I_F = 25\text{A}, -di/dt = 100\text{A}/\mu\text{s},$ $V_R = 100\text{V}, V_{GS} = 0\text{V}$		100	200 ns
$Q_{RM}$			500	nC

Note 1. Pulse test,  $t \leq 300\mu\text{s}$ , duty cycle,  $d \leq 2\%$ .

### TO-247 (IXFH) Outline

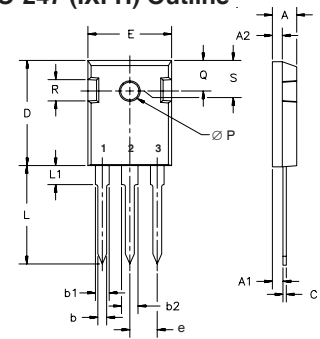

Terminals: 1 - Gate 2 - Drain  
3 - Source Tab - Drain

Dim.	Millimeter		Inches	
	Min.	Max.	Min.	Max.
A	4.7	5.3	.185	.209
A <sub>1</sub>	2.2	2.54	.087	.102
A <sub>2</sub>	2.2	2.6	.059	.098
b	1.0	1.4	.040	.055
b <sub>1</sub>	1.65	2.13	.065	.084
b <sub>2</sub>	2.87	3.12	.113	.123
C	.4	.8	.016	.031
D	20.80	21.46	.819	.845
E	15.75	16.26	.610	.640
e	5.20	5.72	0.205	0.225
L	19.81	20.32	.780	.800
L <sub>1</sub>		4.50		.177
ØP	3.55	3.65	.140	.144
Q	5.89	6.40	0.232	0.252
R	4.32	5.49	.170	.216
S	6.15	BSC	242	BSC

### TO-268 (IXFT) Outline

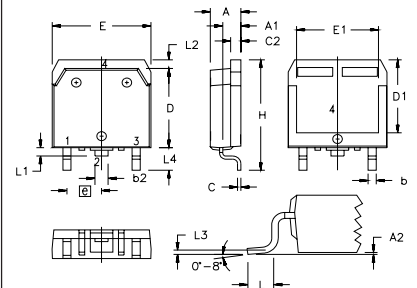

Terminals: 1 - Gate 2 - Drain  
3 - Source Tab - Drain

SYM	INCHES		MILLIMETERS	
	MIN	MAX	MIN	MAX
A	.193	.201	4.90	5.10
A <sub>1</sub>	.106	.114	2.70	2.90
A <sub>2</sub>	.001	.010	0.02	0.25
b	.045	.057	1.15	1.45
b <sub>2</sub>	.075	.083	1.90	2.10
C	.016	.026	0.40	0.65
C <sub>2</sub>	.057	.063	1.45	1.60
D	.543	.551	13.80	14.00
D <sub>1</sub>	.488	.500	12.40	12.70
E	.624	.632	15.85	16.05
E <sub>1</sub>	.524	.535	13.30	13.60
e		.215 BSC		5.45 BSC
H	.736	.752	18.70	19.10
L	.094	.106	2.40	2.70
L <sub>1</sub>	.047	.055	1.20	1.40
L <sub>2</sub>	.039	.045	1.00	1.15
L <sub>3</sub>		.010 BSC		0.25 BSC
L <sub>4</sub>	.150	.161	3.80	4.10

IXYS Reserves the Right to Change Limits, Test Conditions, and Dimensions.

IXYS MOSFETs and IGBTs are covered 4,835,592 4,931,844 5,049,961 5,237,481 6,162,665 6,404,065 B1 6,683,344 6,727,585 7,005,734 B2 7,157,338B2  
by one or more of the following U.S. patents: 4,850,072 5,017,508 5,063,307 5,381,025 6,259,123 B1 6,534,343 6,710,405 B2 6,759,692 7,063,975 B2  
4,881,106 5,034,796 5,187,117 5,486,715 6,306,728 B1 6,583,505 6,710,463 6,771,478 B2 7,071,537

**Fig. 1. Output Characteristics @  $T_J = 25^\circ\text{C}$**

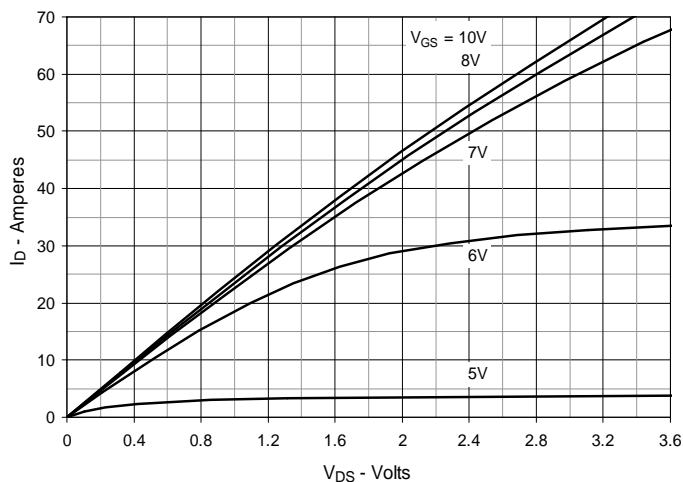

**Fig. 2. Extended Output Characteristics @  $T_J = 25^\circ\text{C}$**

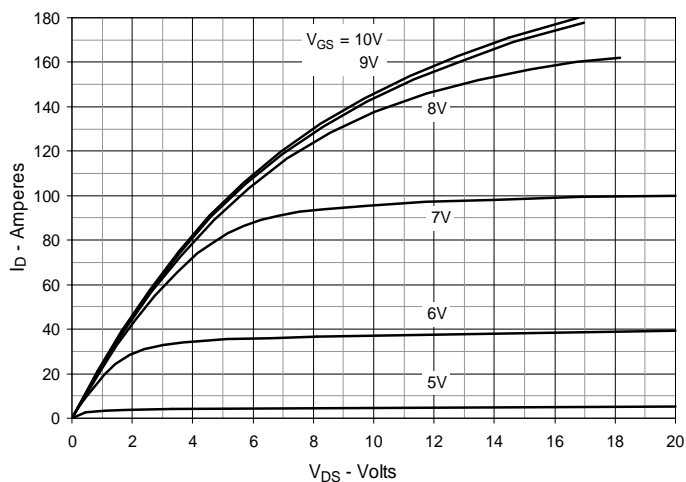

**Fig. 3. Output Characteristics @  $T_J = 125^\circ\text{C}$**

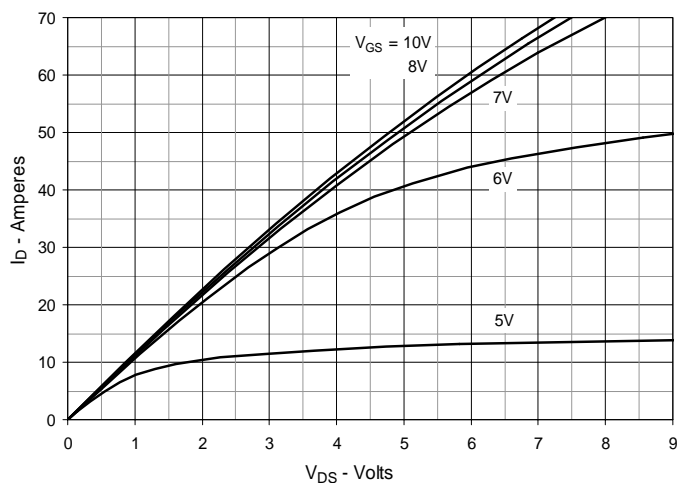

**Fig. 4.  $R_{DS(on)}$  Normalized to  $I_D = 34.5\text{A}$  Value vs. Junction Temperature**

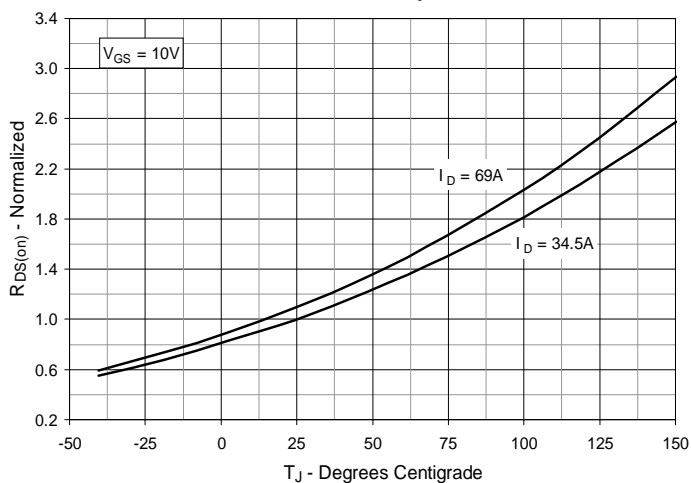

**Fig. 5.  $R_{DS(on)}$  Normalized to  $I_D = 34.5\text{A}$  Value vs. Drain Current**

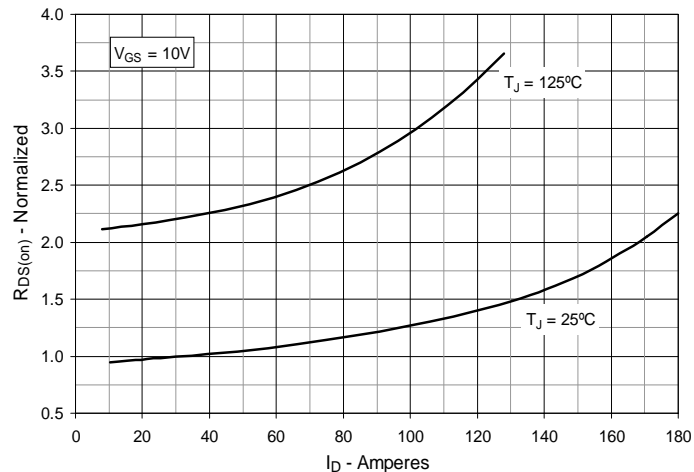

**Fig. 6. Maximum Drain Current vs. Case Temperature**

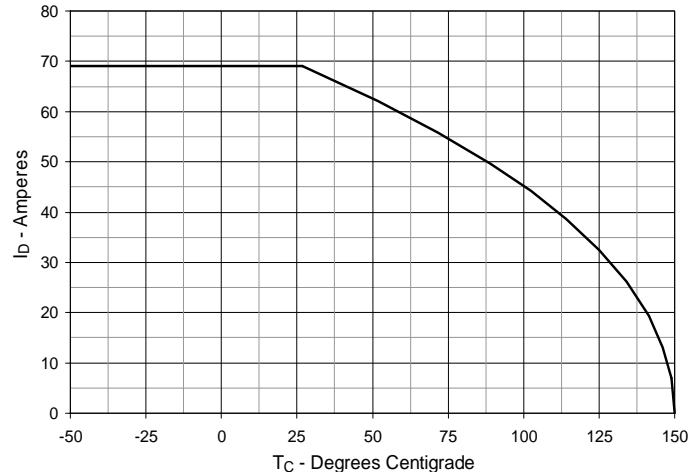

**Fig. 7. Input Admittance**

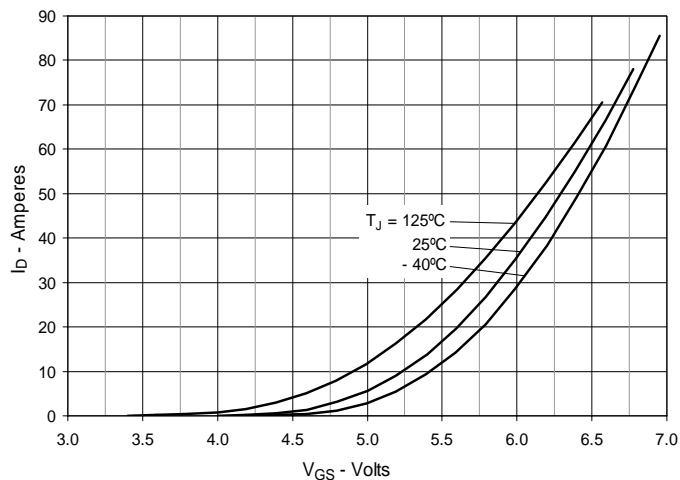

**Fig. 8. Transconductance**

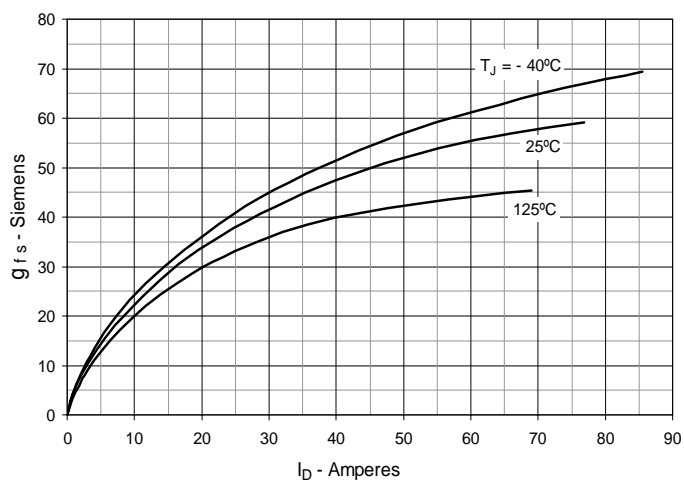

**Fig. 9. Forward Voltage Drop of Intrinsic Diode**

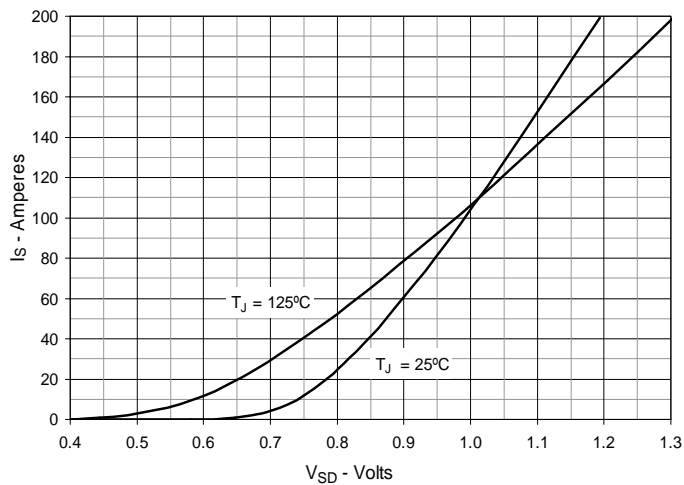

**Fig. 10. Gate Charge**

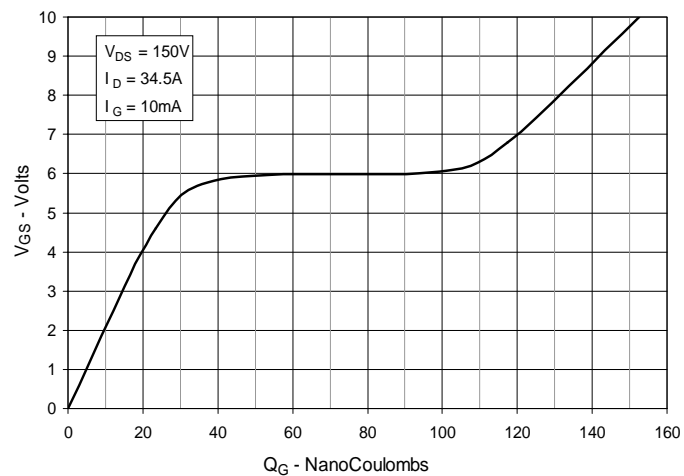

**Fig. 11. Capacitance**

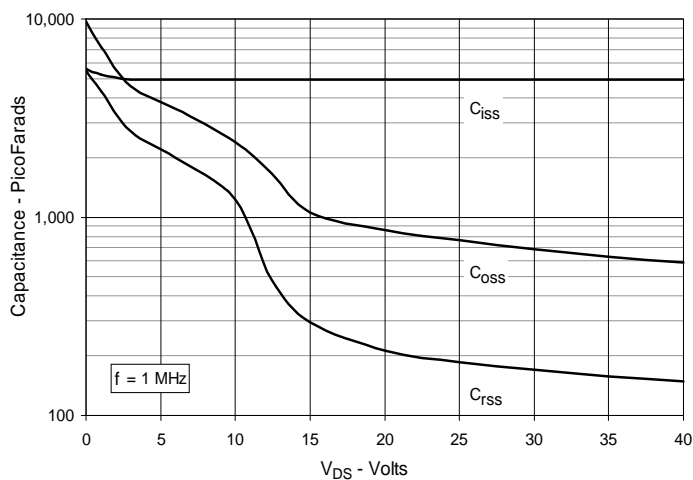

**Fig. 12. Forward-Bias Safe Operating Area**

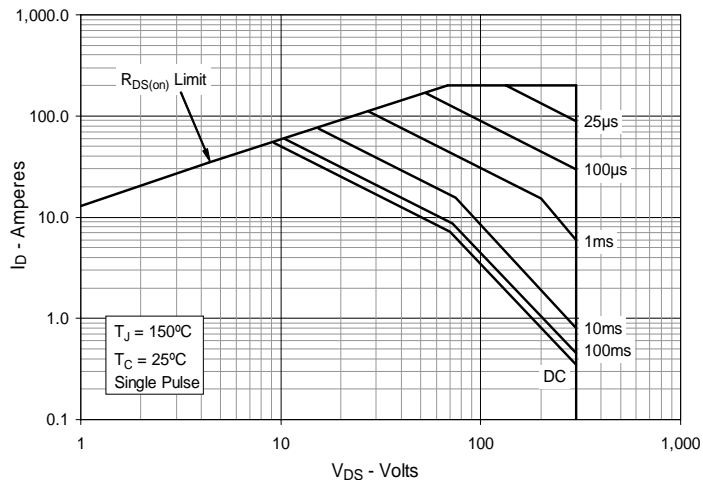

Fig. 12. Maximum Transient Thermal Impedance

