

# HiPerFET™ Power MOSFETs

Single MOSFET Die

	$V_{DSS}$	$I_{DSS}$	$R_{DS(on)}$	$t_{rr}$
<b>IXFK/IXFX 26N90</b>	900 V	26 A	0.30 $\Omega$	250 ns
<b>IXFK/IXFX 25N90</b>	900 V	25 A	0.33 $\Omega$	250 ns

Preliminary data sheet

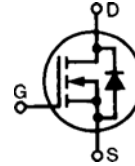

Symbol	Test Conditions	Maximum Ratings	
$V_{DSS}$	$T_J = 25^\circ\text{C}$ to $150^\circ\text{C}$	900	V
$V_{DGR}$	$T_J = 25^\circ\text{C}$ to $150^\circ\text{C}$ ; $R_{GS} = 1\text{ M}\Omega$	900	V
$V_{GS}$	Continuous	$\pm 20$	V
$V_{GSM}$	Transient	$\pm 30$	V
$I_{D25}$	$T_C = 25^\circ\text{C}$	26N90: 26 25N90: 25	A
$I_{DM}$	$T_C = 25^\circ\text{C}$ , pulse width limited by $T_{JM}$	26N90: 104 25N90: 100	A
$I_{AR}$	$T_C = 25^\circ\text{C}$	26N90: 26 25N90: 25	A
$E_{AR}$	$T_C = 25^\circ\text{C}$	64	mJ
$E_{AS}$	$T_C = 25^\circ\text{C}$	3	J
$dv/dt$	$I_S \leq I_{DM}$ , $di/dt \leq 100\text{ A}/\mu\text{s}$ , $V_{DD} \leq V_{DSS}$ $T_J \leq 150^\circ\text{C}$ , $R_G = 2\ \Omega$	5	V/ns
$P_D$	$T_C = 25^\circ\text{C}$	560	W
$T_J$		-55 ... +150	$^\circ\text{C}$
$T_{JM}$		150	$^\circ\text{C}$
$T_{stg}$		-55 ... +150	$^\circ\text{C}$
$T_L$	1.6 mm (0.063 in.) from case for 10 s	300	$^\circ\text{C}$
$M_d$	Mounting torque	TO-264: 0.4/6	Nm/lb.in.
<b>Weight</b>		PLUS 247: 6 g TO-264: 10 g	

## PLUS 247™ (IXFX)

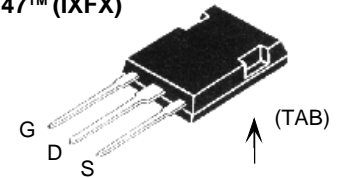

## TO-264 AA (IXFK)

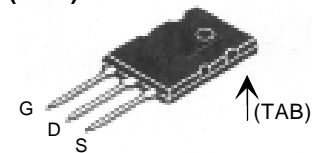

G = Gate  
S = Source

D = Drain  
TAB = Drain

## Features

- International standard packages
- Low  $R_{DS(on)}$  HDMOS™ process
- Rugged polysilicon gate cell structure
- Unclamped Inductive Switching (UIS) rated
- Low package inductance
  - easy to drive and to protect
- Fast intrinsic rectifier

## Applications

- DC-DC converters
- Battery chargers
- Switched-mode and resonant-mode power supplies
- DC choppers
- AC motor control
- Temperature and lighting controls

## Advantages

- PLUS 247™ package for clip or spring mounting
- Space savings
- High power density

Symbol	Test Conditions	Characteristic Values ( $T_J = 25^\circ\text{C}$ , unless otherwise specified)		
		min.	typ.	max.
$V_{DSS}$	$V_{GS} = 0\text{ V}$ , $I_D = 3\text{ mA}$	900		V
$V_{GS(th)}$	$V_{DS} = V_{GS}$ , $I_D = 8\text{ mA}$	3.0		5.0 V
$I_{GSS}$	$V_{GS} = \pm 20\text{ V}$ , $V_{DS} = 0$			$\pm 200\text{ nA}$
$I_{DSS}$	$V_{DS} = 0.8 \cdot V_{DSS}$ , $V_{GS} = 0\text{ V}$		$T_J = 25^\circ\text{C}$ $T_J = 125^\circ\text{C}$	100 $\mu\text{A}$ 2 mA
$R_{DS(on)}$	$V_{GS} = 10\text{ V}$ , $I_D = 0.5 \cdot I_{D25}$ Note 1	26N90: 0.3 25N90: 0.33		$\Omega$

Symbol	Test Conditions	Characteristic Values ( $T_J = 25^\circ\text{C}$ , unless otherwise specified)		
		min.	typ.	max.
$g_{fs}$	$V_{DS} = 10\text{ V}; I_D = 0.5 \cdot I_{D25}$ Note 1	18	28	S
$C_{iss}$	$V_{GS} = 0\text{ V}, V_{DS} = 25\text{ V}, f = 1\text{ MHz}$		8.7	10.8 nF
$C_{oss}$			800	1000 pF
$C_{rss}$			300	375 pF
$t_{d(on)}$	$V_{GS} = 10\text{ V}, V_{DS} = 0.5 \cdot V_{DSS}, I_D = 0.5 \cdot I_{D25}$ $R_G = 1\ \Omega$ (External),		60	ns
$t_r$			35	ns
$t_{d(off)}$			130	ns
$t_f$			24	ns
$Q_{g(on)}$	$V_{GS} = 10\text{ V}, V_{DS} = 0.5 \cdot V_{DSS}, I_D = 0.5 \cdot I_{D25}$		240	nC
$Q_{gs}$			56	nC
$Q_{gd}$			107	nC
$R_{thJC}$			0.22	K/W
$R_{thCK}$		0.15		K/W

Symbol	Test Conditions	Characteristic Values ( $T_J = 25^\circ\text{C}$ , unless otherwise specified)		
		min.	typ.	max.
$I_S$	$V_{GS} = 0\text{ V}$	26N90 25N90		26 25 A
$I_{SM}$	Repetitive; pulse width limited by $T_{JM}$	26N90 25N90		104 100 A
$V_{SD}$	$I_F = I_S, V_{GS} = 0\text{ V}$ , Note 1			1.5 V
$t_{rr}$	$I_F = I_S, -di/dt = 100\text{ A}/\mu\text{s}, V_R = 100\text{ V}$			250 ns
$Q_{RM}$			1.4	$\mu\text{C}$
$I_{RM}$			10	A

Note: 1. Pulse test,  $t \leq 300\ \mu\text{s}$ , duty cycle  $d \leq 2\%$

### PLUS 247™ Outline

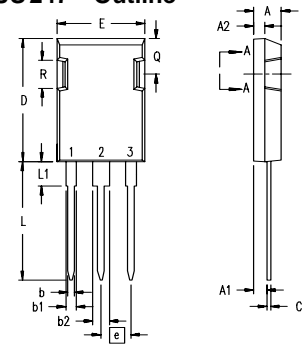

Terminals: 1 - Gate  
2 - Drain (Collector)  
3 - Source (Emitter)  
4 - Drain (Collector)

Dim.	Millimeter		Inches	
	Min.	Max.	Min.	Max.
A	4.83	5.21	.190	.205
A <sub>1</sub>	2.29	2.54	.090	.100
A <sub>2</sub>	1.91	2.16	.075	.085
b	1.14	1.40	.045	.055
b <sub>1</sub>	1.91	2.13	.075	.084
b <sub>2</sub>	2.92	3.12	.115	.123
C	0.61	0.80	.024	.031
D	20.80	21.34	.819	.840
E	15.75	16.13	.620	.635
e	5.45 BSC		.215 BSC	
L	19.81	20.32	.780	.800
L1	3.81	4.32	.150	.170
Q	5.59	6.20	.220	0.244
R	4.32	4.83	.170	.190

### TO-264 AA Outline

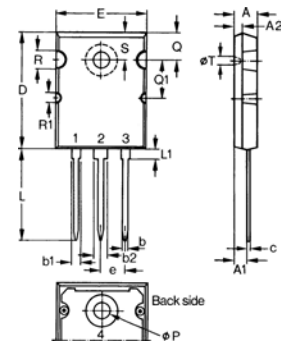

Dim.	Millimeter		Inches	
	Min.	Max.	Min.	Max.
A	4.82	5.13	.190	.202
A1	2.54	2.89	.100	.114
A2	2.00	2.10	.079	.083
b	1.12	1.42	.044	.056
b1	2.39	2.69	.094	.106
b2	2.90	3.09	.114	.122
c	0.53	0.83	.021	.033
D	25.91	26.16	1.020	1.030
E	19.81	19.96	.780	.786
e	5.46 BSC		.215 BSC	
J	0.00	0.25	.000	.010
K	0.00	0.25	.000	.010
L	20.32	20.83	.800	.820
L1	2.29	2.59	.090	.102
P	3.17	3.66	.125	.144
Q	6.07	6.27	.239	.247
Q1	8.38	8.69	.330	.342
R	3.81	4.32	.150	.170
R1	1.78	2.29	.070	.090
S	6.04	6.30	.238	.248
T	1.57	1.83	.062	.072

IXYS reserves the right to change limits, test conditions, and dimensions.

IXYS MOSFETs and IGBTs are covered by one or more of the following U.S. patents: 4,835,592 4,881,106 5,017,508 5,049,961 5,187,117 5,486,715  
4,850,072 4,931,844 5,034,796 5,063,307 5,237,481 5,381,025

Figure 1. Output Characteristics at 25°C

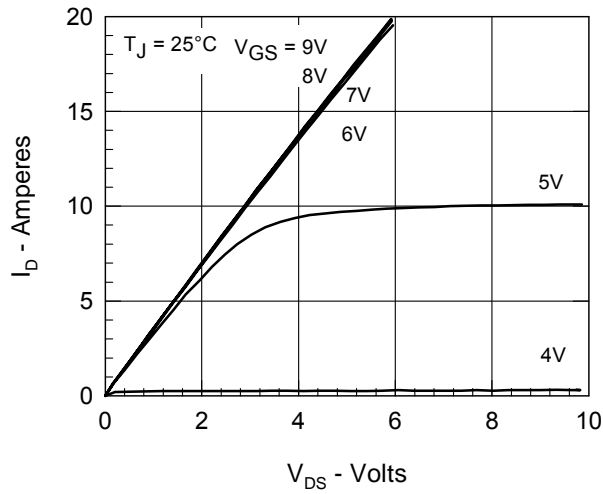

Figure 2. Extended Output Characteristics at 125°C

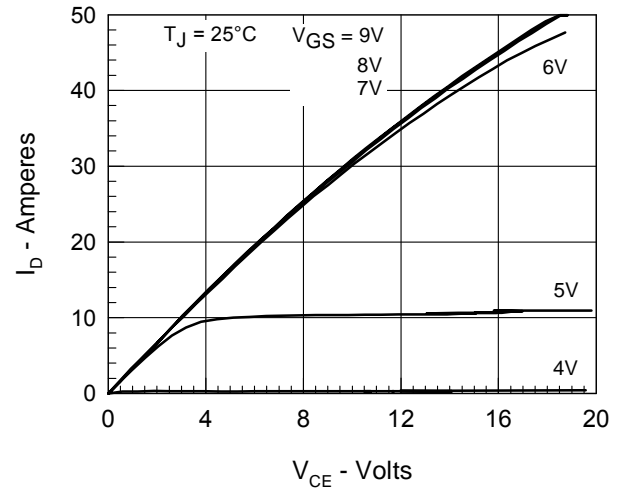

Figure 3.  $R_{DS(on)}$  normalized to 0.5  $I_{D25}$  value vs.  $I_D$

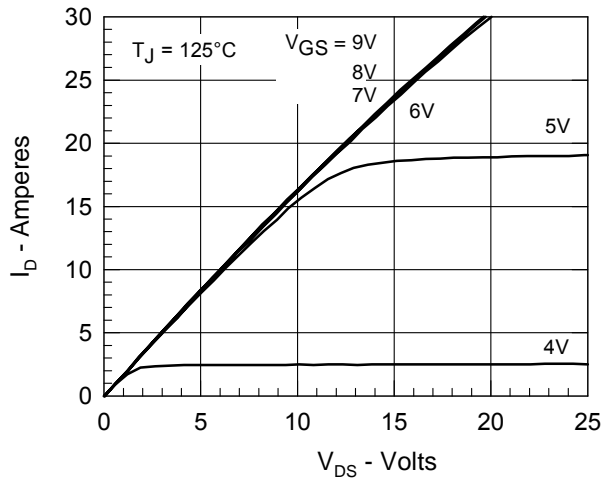

Figure 4. Admittance Curves

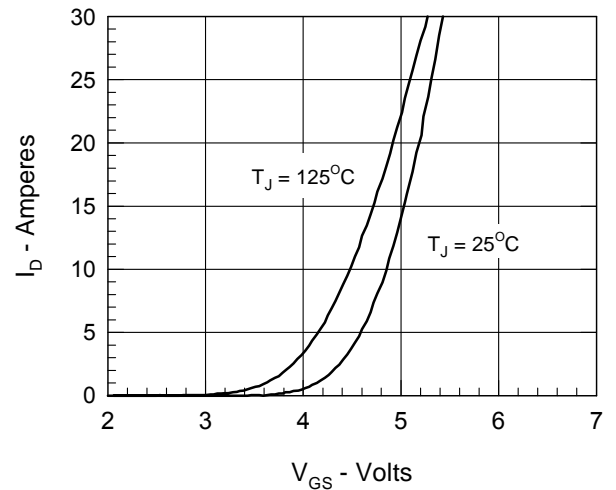

Figure 5.  $R_{DS(on)}$  normalized to 0.5  $I_{D25}$  value vs.  $I_D$

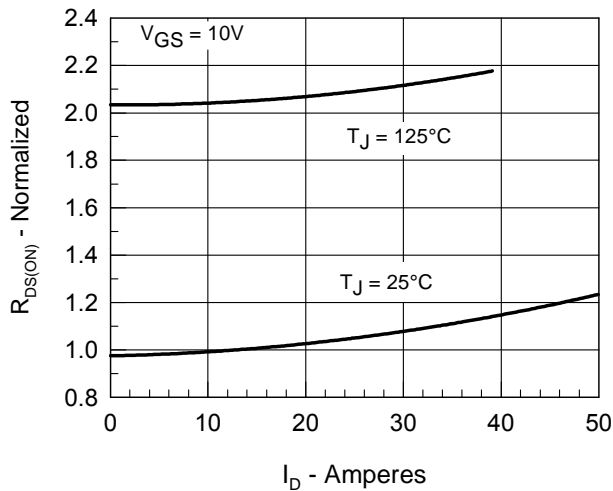

Figure 6.  $R_{DS(on)}$  normalized to 0.5  $I_{D25}$  value vs.  $T_J$

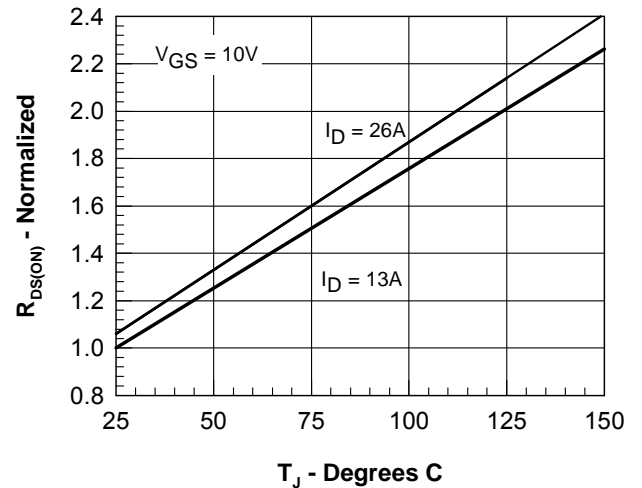

Figure 7. Gate Charge

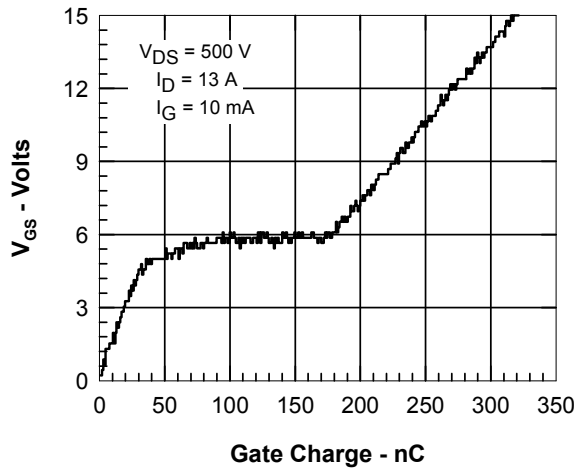

Figure 8. Capacitance Curves

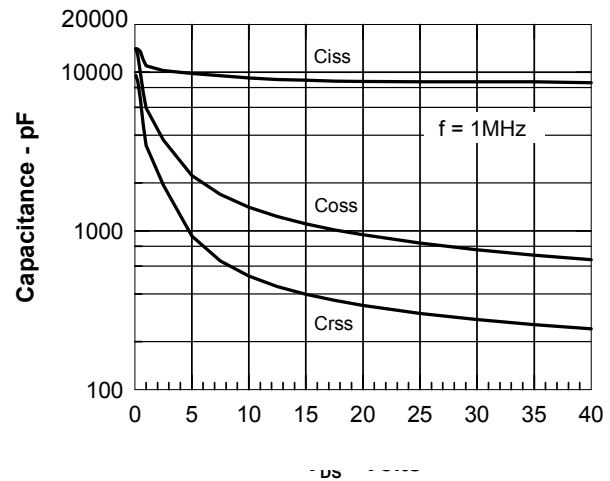

Figure 9. Forward Voltage Drop of the Intrinsic Diode

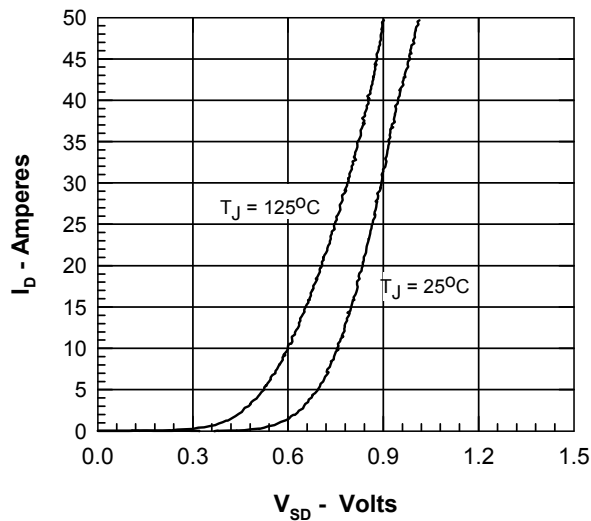

Figure 10. Drain Current vs. Case Temperature

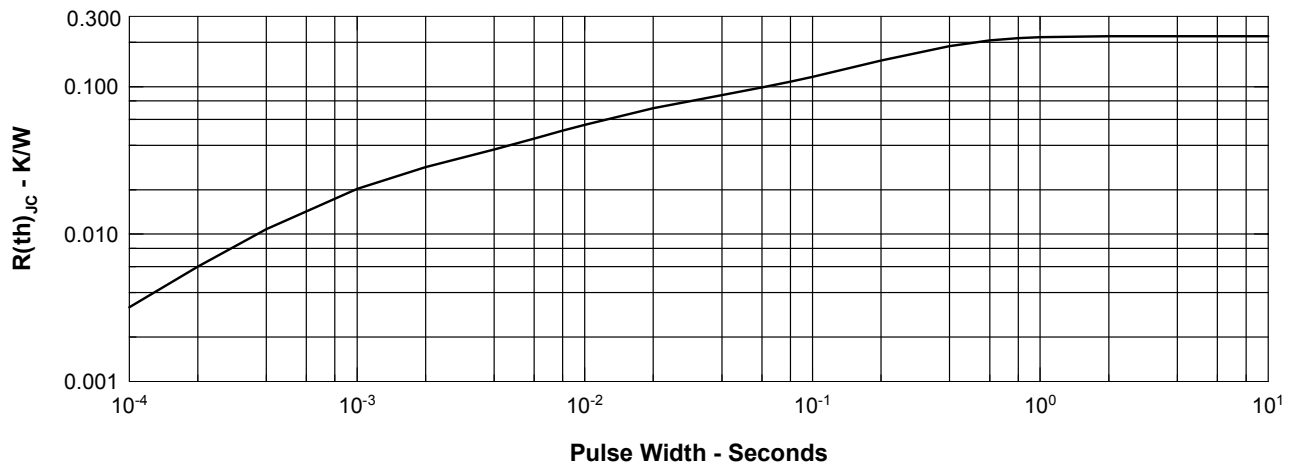
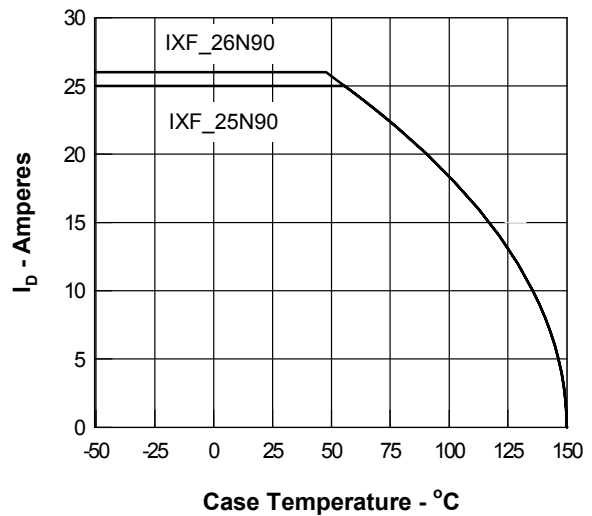

Figure 11. Transient Thermal Resistance

IXYS reserves the right to change limits, test conditions, and dimensions.

IXYS MOSFETs and IGBTs are covered by one or more of the following U.S. patents:

4,835,592	4,881,106	5,017,508	5,049,961	5,187,117	5,486,715
4,850,072	4,931,844	5,034,796	5,063,307	5,237,481	5,381,025