

**GigaMOS™ TrenchT2**  
**HiperFET™**  
**Power MOSFET**

**IXFK320N17T2**  
**IXFX320N17T2**

$V_{DSS} = 170V$   
 $I_{D25} = 320A$   
 $R_{DS(on)} \leq 5.2m\Omega$   
 $t_{rr} \leq 150ns$

N-Channel Enhancement Mode  
 Avalanche Rated  
 Fast Intrinsic Diode

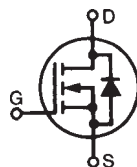

Symbol	Test Conditions	Maximum Ratings	
$V_{DSS}$	$T_J = 25^\circ C$ to $175^\circ C$	170	V
$V_{DGR}$	$T_J = 25^\circ C$ to $175^\circ C$ , $R_{GS} = 1M\Omega$	170	V
$V_{GSS}$	Continuous	$\pm 20$	V
$V_{GSM}$	Transient	$\pm 30$	V
$I_{D25}$	$T_C = 25^\circ C$ (Chip Capability)	320	A
$I_{L(RMS)}$	External Lead Current Limit	160	A
$I_{DM}$	$T_C = 25^\circ C$ , Pulse Width Limited by $T_{JM}$	800	A
$I_A$	$T_C = 25^\circ C$	100	A
$E_{AS}$	$T_C = 25^\circ C$	5	J
$P_D$	$T_C = 25^\circ C$	1670	W
$dV/dt$	$I_S \leq I_{DM}$ , $V_{DD} \leq V_{DSS}$ , $T_J \leq 175^\circ C$	20	V/ns
$T_J$		-55 ... +175	$^\circ C$
$T_{JM}$		175	$^\circ C$
$T_{stg}$		-55 ... +175	$^\circ C$
$T_L$	1.6mm (0.062 in.) from Case for 10s	300	$^\circ C$
$T_{SOLD}$	Plastic Body for 10s	260	$^\circ C$
$M_d$	Mounting Torque (TO-264)	1.13/10	Nm/lb.in.
$F_C$	Mounting Force (PLUS247)	20..120 /4.5..27	N/lb.
<b>Weight</b>	TO-264	10	g
	PLUS247	6	g

Symbol	Test Conditions ( $T_J = 25^\circ C$ Unless Otherwise Specified)	Characteristic Values		
		Min.	Typ.	Max.
$BV_{DSS}$	$V_{GS} = 0V$ , $I_D = 3mA$	170		V
$V_{GS(th)}$	$V_{DS} = V_{GS}$ , $I_D = 8mA$	2.5		5.0 V
$I_{GSS}$	$V_{GS} = \pm 20V$ , $V_{DS} = 0V$			$\pm 200$ nA
$I_{DSS}$	$V_{DS} = V_{DSS}$ , $V_{GS} = 0V$ $T_J = 150^\circ C$			50 $\mu A$ 5 mA
$R_{DS(on)}$	$V_{GS} = 10V$ , $I_D = 60A$ , Note 1			5.2 m $\Omega$

TO-264 (IXFK)

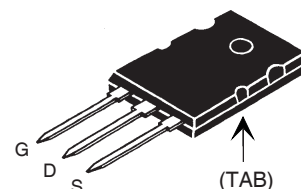

PLUS247 (IXFX)

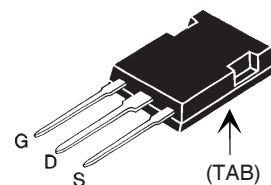

G = Gate      D = Drain  
 S = Source    TAB = Drain

### Features

- International Standard Packages
- High Current Handling Capability
- Fast Intrinsic Diode
- Avalanche Rated
- Low  $R_{DS(on)}$

### Advantages

- Easy to Mount
- Space Savings
- High Power Density

### Applications

- Synchronous Rectification
- DC-DC Converters
- Battery Chargers
- Switch-Mode and Resonant-Mode Power Supplies
- DC Choppers
- AC Motor Drives
- Uninterruptible Power Supplies
- High Speed Power Switching Applications

Symbol	Test Conditions	Characteristic Values		
		Min.	Typ.	Max.
$g_{fs}$	$V_{DS} = 10V, I_D = 60A, \text{Note 1}$	120	190	S
$C_{iss}$	$V_{GS} = 0V, V_{DS} = 25V, f = 1MHz$		45	nF
$C_{oss}$			2890	pF
$C_{rss}$			410	pF
$R_{Gi}$	Gate Input Resistance		1.96	$\Omega$
$t_{d(on)}$	<b>Resistive Switching Times</b> $V_{GS} = 10V, V_{DS} = 0.5 \cdot V_{DSS}, I_D = 100A$ $R_G = 1\Omega$ (External)		46	ns
$t_r$			170	ns
$t_{d(off)}$			115	ns
$t_f$			230	ns
$Q_{g(on)}$	$V_{GS} = 10V, V_{DS} = 0.5 \cdot V_{DSS}, I_D = 0.5 \cdot I_{D25}$		640	nC
$Q_{gs}$			185	nC
$Q_{gd}$			175	nC
$R_{thJC}$			0.09	$^{\circ}C/W$
$R_{thCS}$		0.15		$^{\circ}C/W$

### Source-Drain Diode

Symbol	Test Conditions	Characteristic Values		
		Min.	Typ.	Max.
$I_S$	$V_{GS} = 0V$			320 A
$I_{SM}$	Repetitive, Pulse Width Limited by $T_{JM}$			1280 A
$V_{SD}$	$I_F = 100A, V_{GS} = 0V, \text{Note 1}$			1.25 V
$t_{rr}$	$I_F = 160A, -di/dt = 100A/\mu s$ $V_R = 60V, V_{GS} = 0V$			150 ns
$Q_{RM}$			0.53	$\mu C$
$I_{RM}$			9.00	A

Note 1. Pulse test,  $t \leq 300\mu s$ ; duty cycle,  $d \leq 2\%$ .

### ADVANCE TECHNICAL INFORMATION

The product presented herein is under development. The Technical Specifications offered are derived from a subjective evaluation of the design, based upon prior knowledge and experience, and constitute a "considered reflection" of the anticipated result. IXYS reserves the right to change limits, test conditions, and dimensions without notice.

IXYS Reserves the Right to Change Limits, Test Conditions, and Dimensions.

IXYS MOSFETs and IGBTs are covered 4,835,592 4,931,844 5,049,961 5,237,481 6,162,665 6,404,065 B1 6,683,344 6,727,585 7,005,734 B2 7,157,338B2  
by one or more of the following U.S. patents: 4,850,072 5,017,508 5,063,307 5,381,025 6,259,123 B1 6,534,343 6,710,405 B2 6,759,692 7,063,975 B2  
4,881,106 5,034,796 5,187,117 5,486,715 6,306,728 B1 6,583,505 6,710,463 6,771,478 B2 7,071,537

### TO-264 (IXFK) Outline

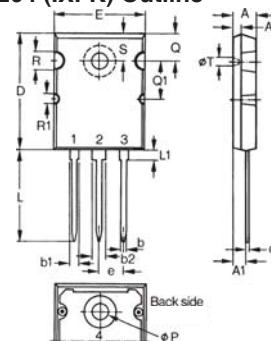

Dim.	Millimeter		Inches	
	Min.	Max.	Min.	Max.
A	4.82	5.13	.190	.202
A1	2.54	2.89	.100	.114
A2	2.00	2.10	.079	.083
b	1.12	1.42	.044	.056
b1	2.39	2.69	.094	.106
b2	2.90	3.09	.114	.122
c	0.53	0.83	.021	.033
D	25.91	26.16	1.020	1.030
E	19.81	19.96	.780	.786
e	5.46 BSC		.215 BSC	
J	0.00	0.25	.000	.010
K	0.00	0.25	.000	.010
L	20.32	20.83	.800	.820
L1	2.29	2.59	.090	.102
P	3.17	3.66	.125	.144
Q	6.07	6.27	.239	.247
Q1	8.38	8.69	.330	.342
R	3.81	4.32	.150	.170
R1	1.78	2.29	.070	.090
S	6.04	6.30	.238	.248
T	1.57	1.83	.062	.072

### PLUS 247™ (IXFX) Outline

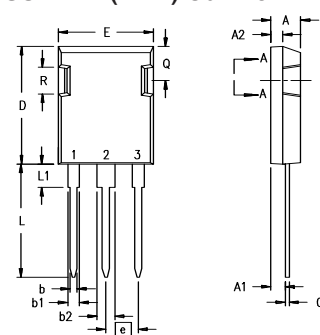

Terminals: 1 - Gate  
2 - Drain (Collector)  
3 - Source (Emitter)  
4 - Drain (Collector)

Dim.	Millimeter		Inches	
	Min.	Max.	Min.	Max.
A	4.83	5.21	.190	.205
A1	2.29	2.54	.090	.100
A2	1.91	2.16	.075	.085
b	1.14	1.40	.045	.055
b1	1.91	2.13	.075	.084
b2	2.92	3.12	.115	.123
C	0.61	0.80	.024	.031
D	20.80	21.34	.819	.840
E	15.75	16.13	.620	.635
e	5.45 BSC		.215 BSC	
L	19.81	20.32	.780	.800
L1	3.81	4.32	.150	.170
Q	5.59	6.20	.220	0.244
R	4.32	4.83	.170	.190

**Fig. 1. Output Characteristics**  
@  $T_J = 25^\circ\text{C}$

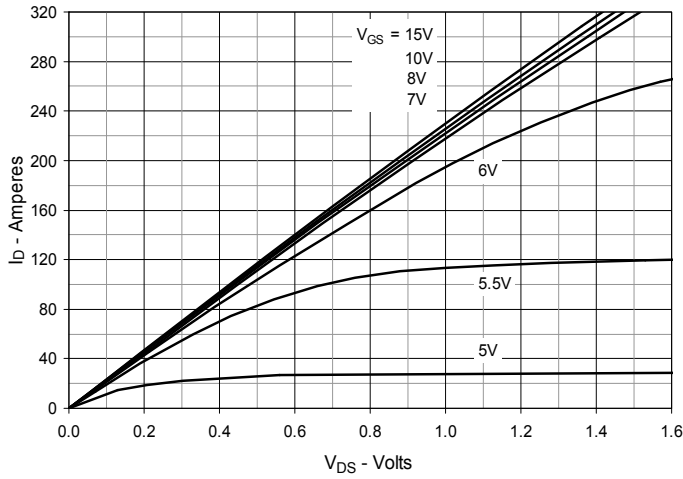

**Fig. 2. Extended Output Characteristics**  
@  $T_J = 25^\circ\text{C}$

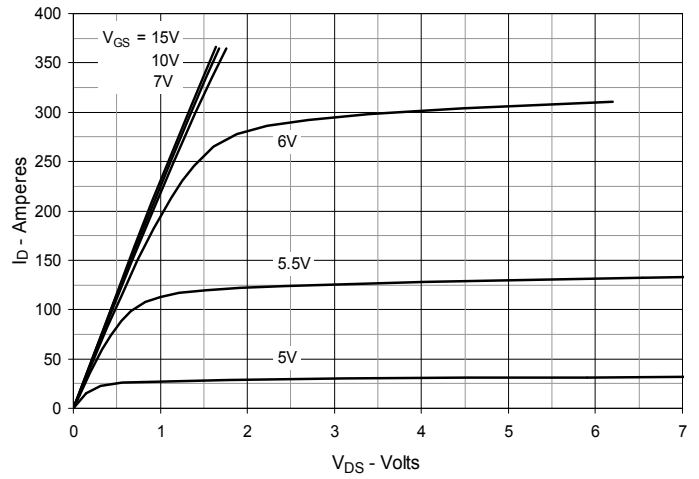

**Fig. 3. Output Characteristics**  
@  $T_J = 150^\circ\text{C}$

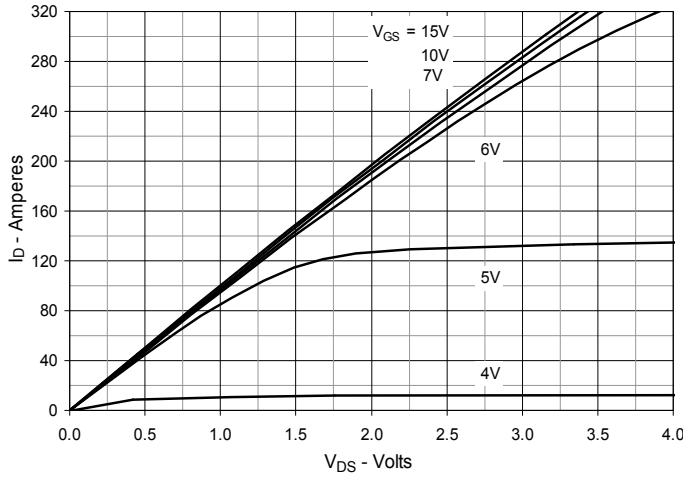

**Fig. 4.  $R_{DS(on)}$  Normalized to  $I_D = 160\text{A}$  Value vs. Junction Temperature**

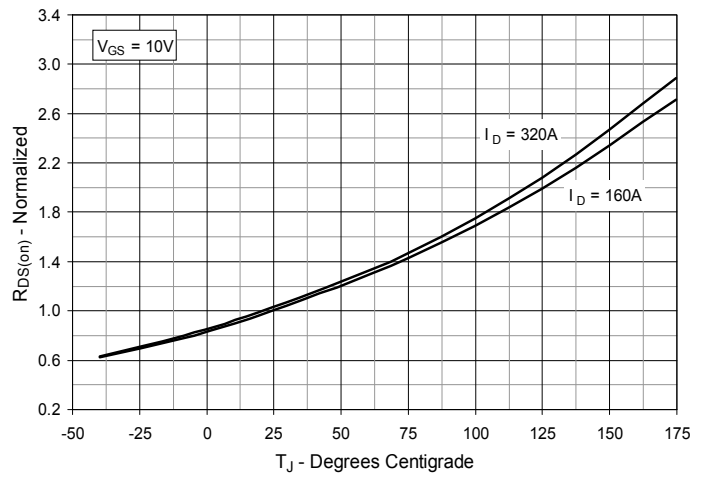

**Fig. 5.  $R_{DS(on)}$  Normalized to  $I_D = 160\text{A}$  Value vs. Drain Current**

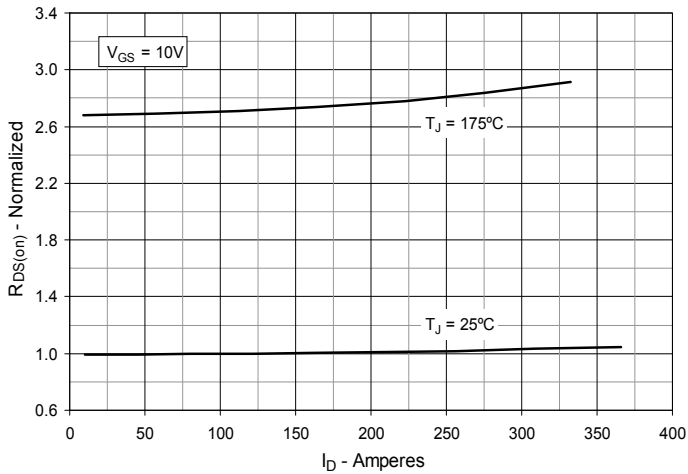

**Fig. 6. Drain Current vs. Case Temperature**

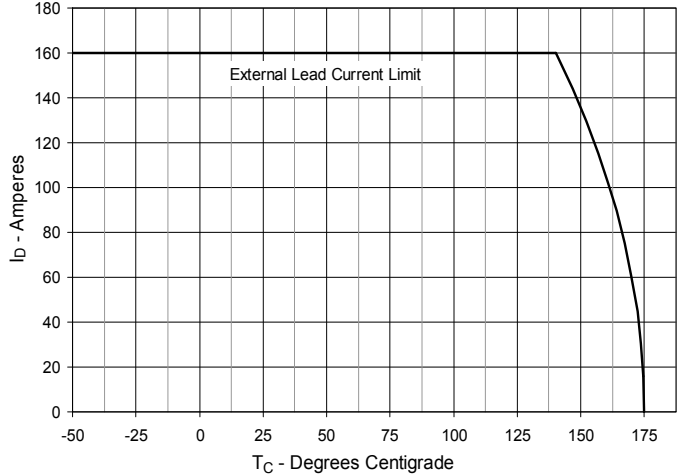

**Fig. 7. Input Admittance**

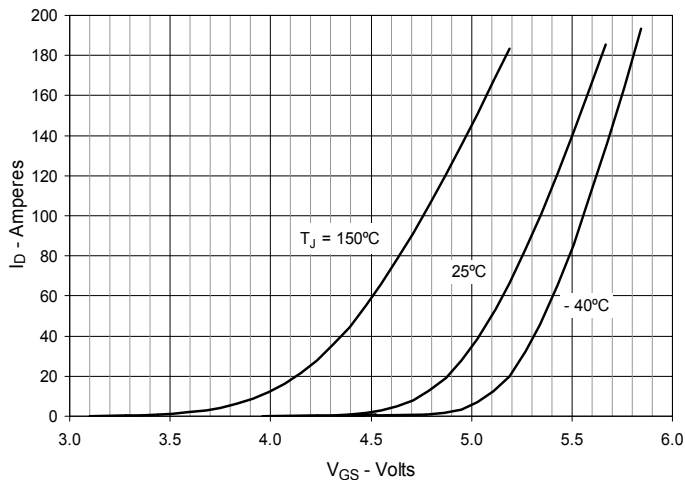

**Fig. 8. Transconductance**

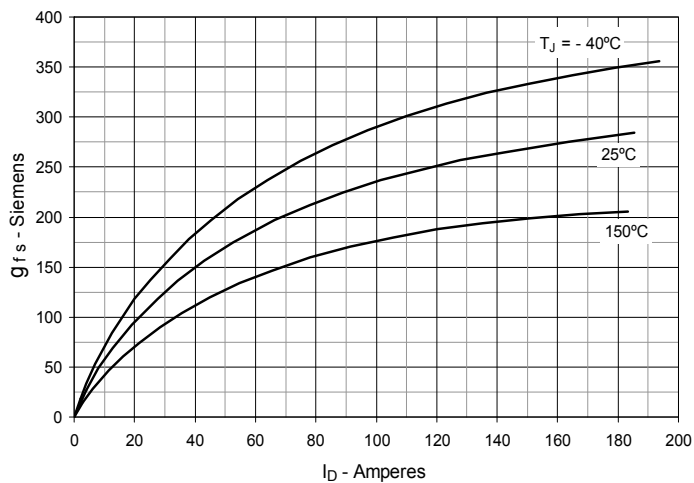

**Fig. 9. Forward Voltage Drop of Intrinsic Diode**

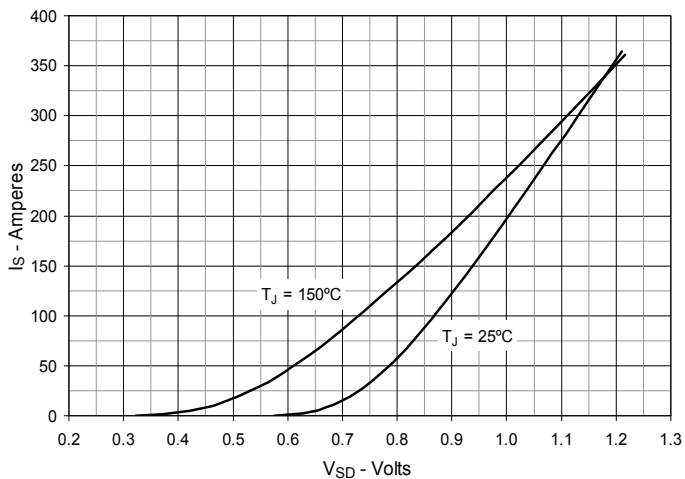

**Fig. 10. Gate Charge**

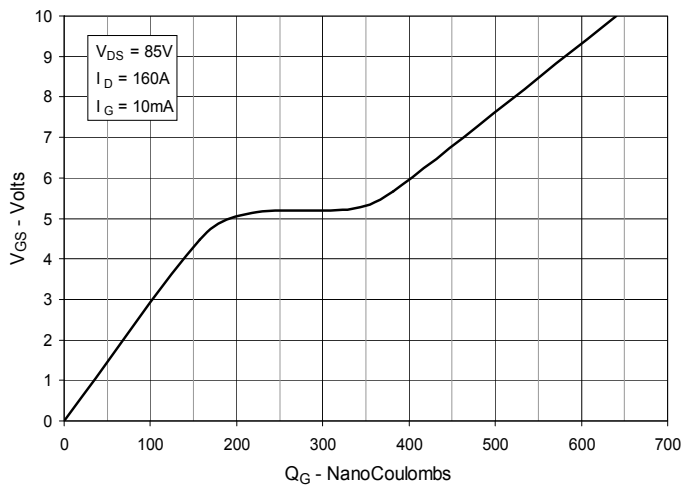

**Fig. 11. Capacitance**

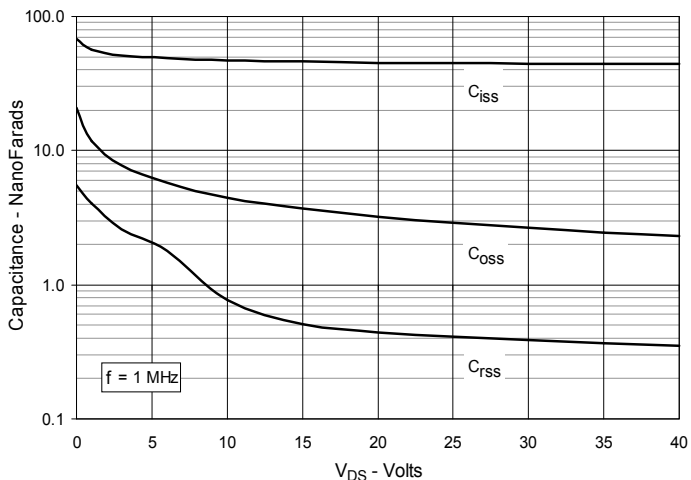

**Fig. 12. Forward-Bias Safe Operating Area**

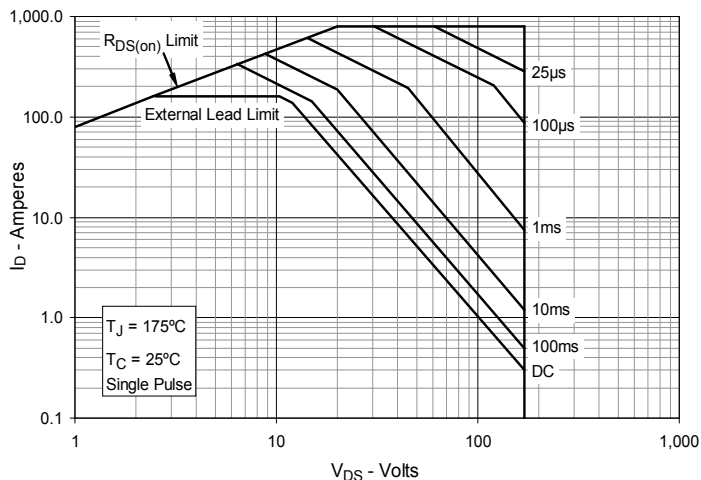

**Fig. 13. Resistive Turn-on Rise Time vs. Junction Temperature**

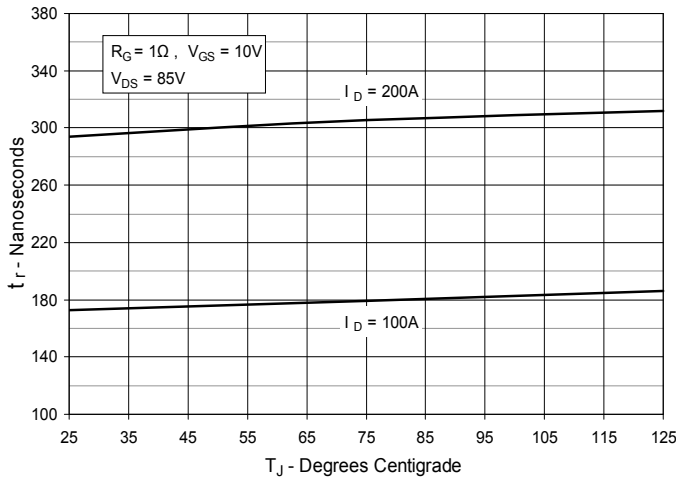

**Fig. 14. Resistive Turn-on Rise Time vs. Drain Current**

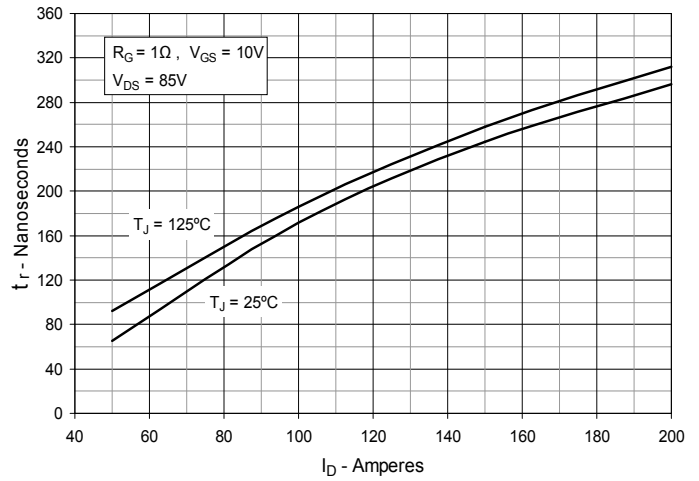

**Fig. 15. Resistive Turn-on Switching Times vs. Gate Resistance**

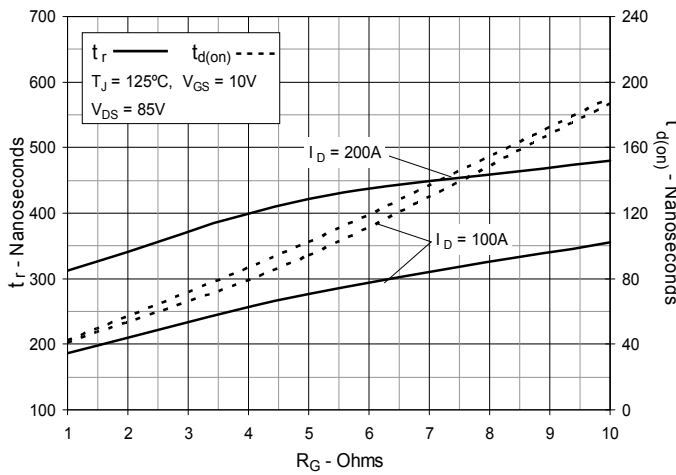

**Fig. 16. Resistive Turn-off Switching Times vs. Junction Temperature**

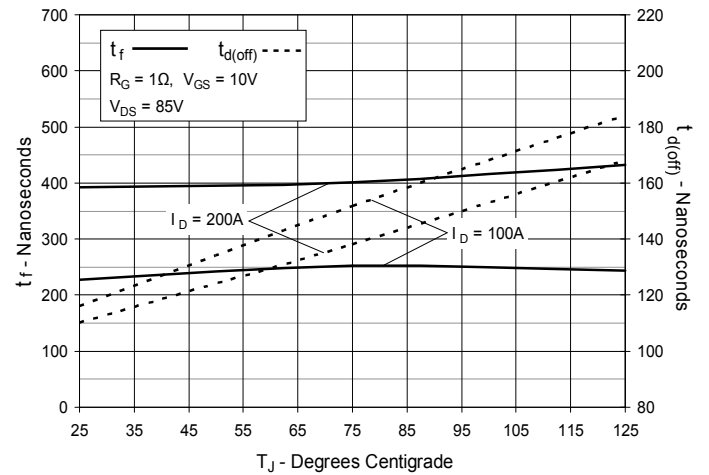

**Fig. 17. Resistive Turn-off Switching Times vs. Drain Current**

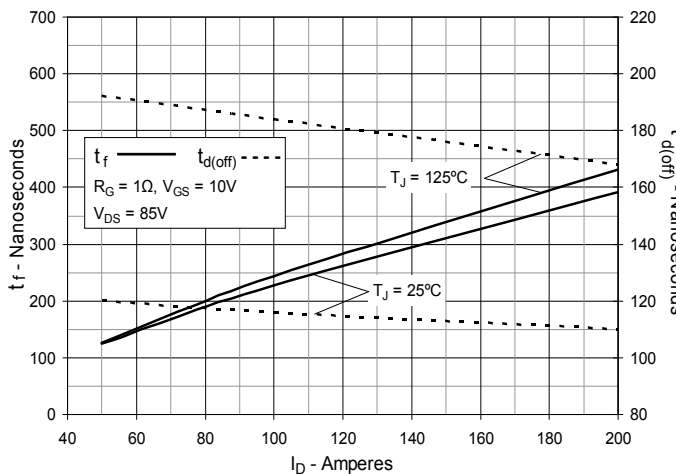

**Fig. 18. Resistive Turn-off Switching Times vs. Gate Resistance**

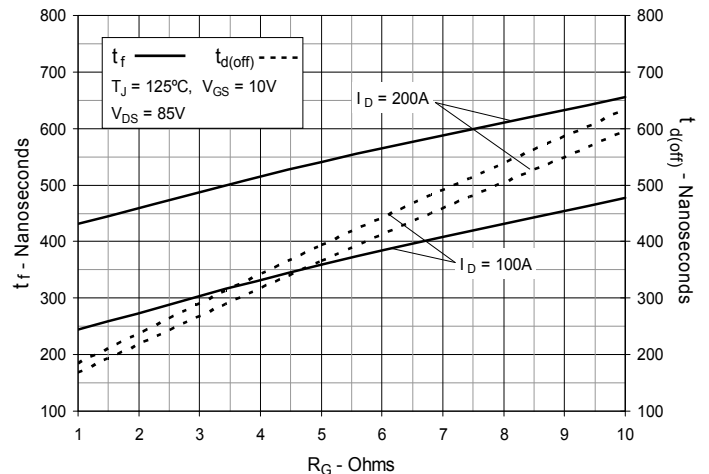

Fig. 19. Maximum Transient Thermal Impedance

