

**GenX3™ 300V IGBT**
**IXGH100N30B3**

Medium speed low  $V_{sat}$  PT  
IGBTs for 10-50 kHz switching



$$V_{CES} = 300V$$

$$I_{C110} = 100A$$

$$V_{CE(sat)} \leq 1.7V$$

$$t_{fi(typ)} = 33ns$$

Symbol	Test Conditions	Maximum Ratings	
$V_{CES}$	$T_J = 25^\circ C$ to $150^\circ C$	300	V
$V_{CGR}$	$T_J = 25^\circ C$ to $150^\circ C$ , $R_{GE} = 1M\Omega$	300	V
$V_{GES}$	Continuous	$\pm 20$	V
$V_{GEM}$	Transient	$\pm 30$	V
$I_{C25}$	$T_C = 25^\circ C$ (limited by leads)	75	A
$I_{C110}$	$T_C = 110^\circ C$	100	A
$I_{CM}$	$T_C = 25^\circ C$ , 1ms	400	A
<b>SSOA</b> <b>(RBSOA)</b>	$V_{GE} = 15V$ , $T_J = 125^\circ C$ , $R_G = 2\Omega$ Clamped inductive load @ $V_{CE} \leq 300V$	$I_{CM} = 200$	A
$P_C$	$T_C = 25^\circ C$	460	W
$T_J$		-55 ... +150	$^\circ C$
$T_{JM}$		150	$^\circ C$
$T_{stg}$		-55 ... +150	$^\circ C$
$M_d$	Mounting torque	1.13 / 10	Nm/lb.in.
$T_L$	Maximum lead temperature for soldering	300	$^\circ C$
$T_{SOLD}$	1.6mm (0.062 in.) from case for 10s	260	$^\circ C$
<b>Weight</b>		6	g

TO-247 (IXGH)

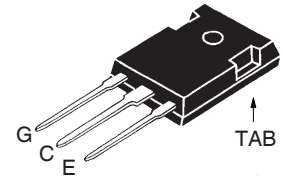

G = Gate      C = Collector  
E = Emitter    TAB = Collector

**Features**

- Optimized for low switching losses
- Square RBSOA
- International standard package

**Advantages**

- High power density
- Low gate drive requirement

**Applications**

- High Frequency Power Inverters
- UPS
- Motor Drives
- SMPS
- PFC Circuits
- Battery Chargers
- Welding Machines
- Lamp Ballasts

Symbol	Test Conditions ( $T_J = 25^\circ C$ , unless otherwise specified)	Characteristic Values		
		Min.	Typ.	Max.
$BV_{CES}$	$I_C = 250\mu A$ , $V_{GE} = 0V$	300		V
$V_{GE(th)}$	$I_C = 250\mu A$ , $V_{CE} = V_{GE}$	3.0		5.0 V
$I_{CES}$	$V_{CE} = V_{CES}$			10 $\mu A$
	$V_{GE} = 0V$ $T_J = 125^\circ C$			500 $\mu A$
$I_{GES}$	$V_{CE} = 0V$ , $V_{GE} = \pm 20V$			$\pm 100$ nA
$V_{CE(sat)}$	$I_C = 100A$ , $V_{GE} = 15V$ , Note 1 $T_J = 125^\circ C$	1.35	1.7	V
		1.40		V

Symbol	Test Conditions ( $T_J = 25^\circ\text{C}$ , unless otherwise specified)	Characteristic Values		
		Min.	Typ.	Max.
$g_{fs}$	$I_C = 50\text{A}, V_{CE} = 10\text{V}$ , Note 1	45	77	S
$C_{ies}$	$V_{CE} = 25\text{V}, V_{GE} = 0\text{V}, f = 1\text{MHz}$		5010	pF
$C_{oes}$			370	pF
$C_{res}$			93	pF
$Q_g$	$I_C = 100\text{A}, V_{GE} = 15\text{V}, V_{CE} = 0.5 \cdot V_{CES}$		166	nC
$Q_{ge}$			30	nC
$Q_{gc}$			65	nC
$t_{d(on)}$	<b>Resistive load, <math>T_J = 25^\circ\text{C}</math></b> $I_C = 50\text{A}, V_{GE} = 15\text{V}$ $V_{CE} = 240\text{V}, R_G = 2\Omega$		27	ns
$t_r$			51	ns
$t_{d(off)}$			110	ns
$t_f$			33	ns
$t_{d(on)}$	<b>Resistive load, <math>T_J = 125^\circ\text{C}</math></b> $I_C = 50\text{A}, V_{GE} = 15\text{V}$ $V_{CE} = 240\text{V}, R_G = 2\Omega$		24	ns
$t_r$			61	ns
$t_{d(off)}$			124	ns
$t_f$			148	ns
$R_{thJC}$				0.27 °C/W
$R_{thCK}$		0.21		°C/W

TO-247 (IXGH) Outline

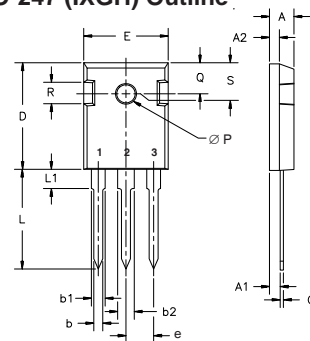

Terminals: 1 - Gate      2 - Drain  
3 - Source      Tab - Drain

Dim.	Millimeter		Inches	
	Min.	Max.	Min.	Max.
A	4.7	5.3	.185	.209
A <sub>1</sub>	2.2	2.54	.087	.102
A <sub>2</sub>	2.2	2.6	.059	.098
b	1.0	1.4	.040	.055
b <sub>1</sub>	1.65	2.13	.065	.084
b <sub>2</sub>	2.87	3.12	.113	.123
C	.4	.8	.016	.031
D	20.80	21.46	.819	.845
E	15.75	16.26	.610	.640
e	5.20	5.72	0.205	0.225
L	19.81	20.32	.780	.800
L1		4.50		.177
ØP	3.55	3.65	.140	.144
Q	5.89	6.40	0.232	0.252
R	4.32	5.49	.170	.216
S	6.15	BSC	242	BSC

Notes: 1. Pulse test,  $t \leq 300\mu\text{s}$ ; duty cycle,  $d \leq 2\%$ .

## PRELIMINARY TECHNICAL INFORMATION

The product presented herein is under development. The Technical Specifications offered are derived from data gathered during objective characterizations of preliminary engineering lots; but also may yet contain some information supplied during a pre-production design evaluation. IXYS reserves the right to change limits, test conditions, and dimensions without notice.

IXYS reserves the right to change limits, test conditions, and dimensions.

IXYS MOSFETs and IGBTs are covered by one or more of the following U.S. patents:

4,835,592	4,931,844	5,049,961	5,237,481	6,162,665	6,404,065 B1	6,683,344	6,727,585	7,005,734 B2	7,157,338B2
4,850,072	5,017,508	5,063,307	5,381,025	6,259,123 B1	6,534,343	6,710,405 B2	6,759,692	7,063,975 B2	
4,881,106	5,034,796	5,187,117	5,486,715	6,306,728 B1	6,583,505	6,710,463	6,771,478 B2	7,071,537	

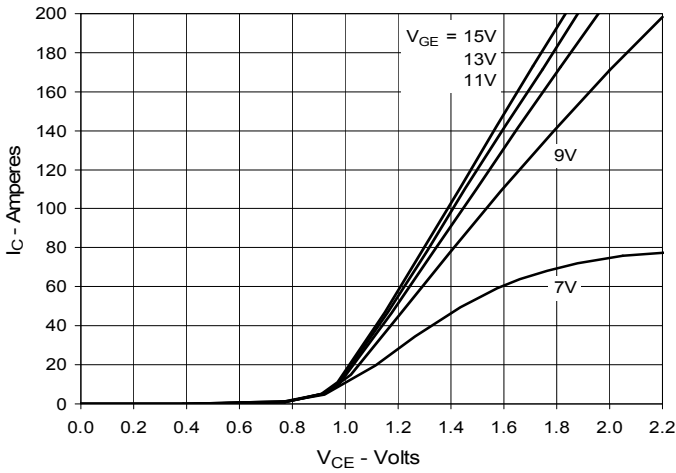
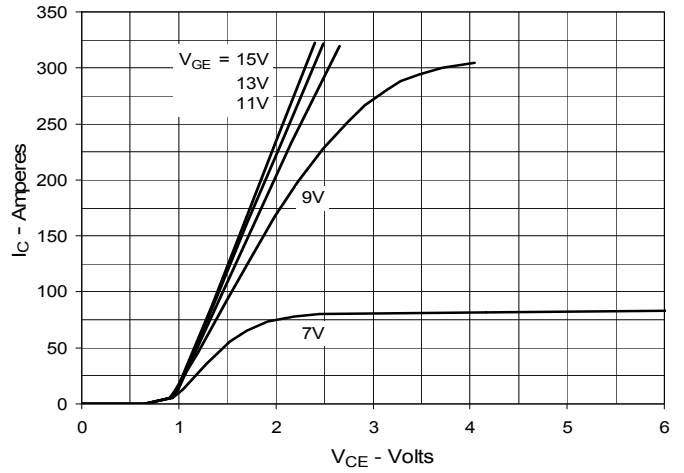
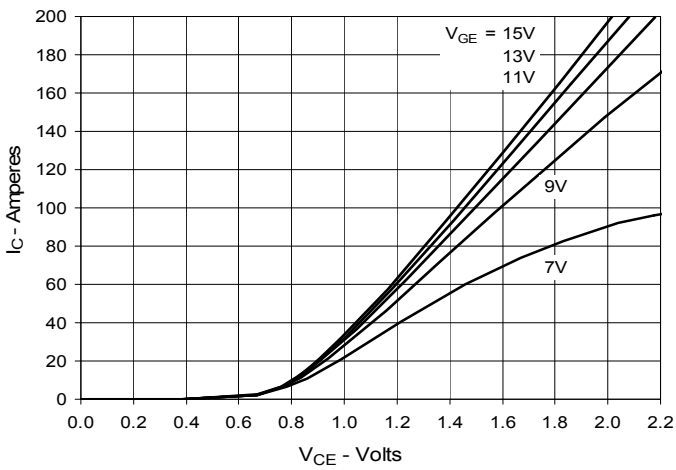
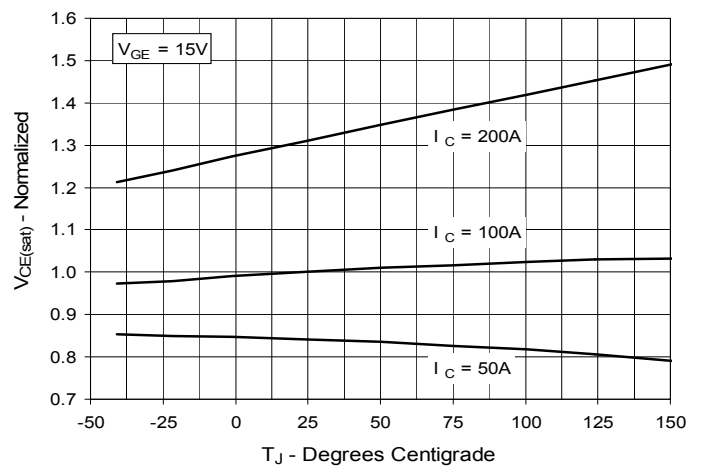
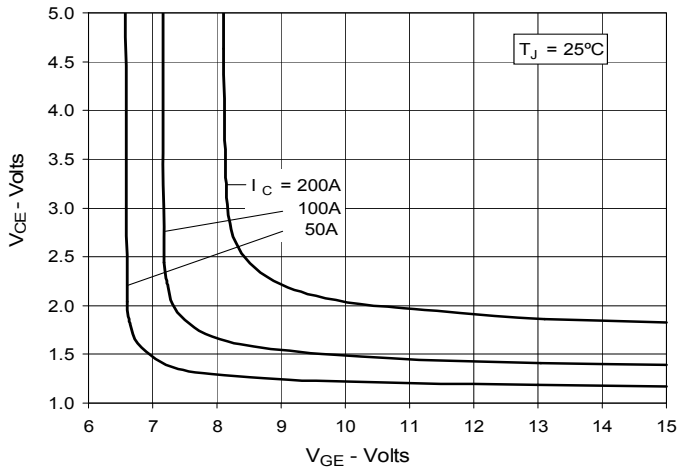
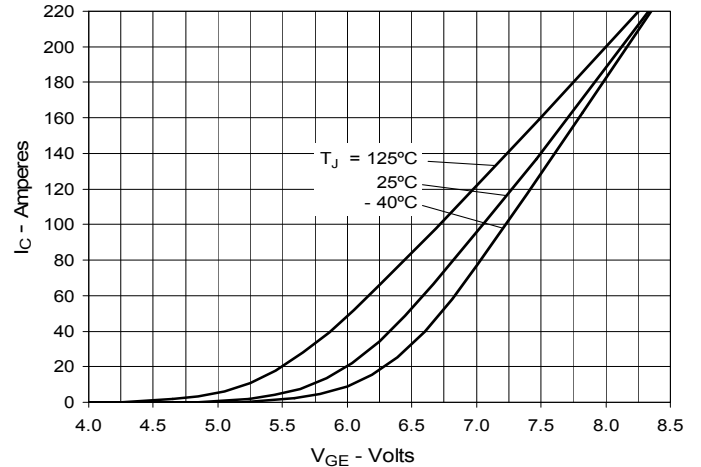
**Fig. 1. Output Characteristics  
@ 25°C**

**Fig. 2. Extended Output Characteristics  
@ 25°C**

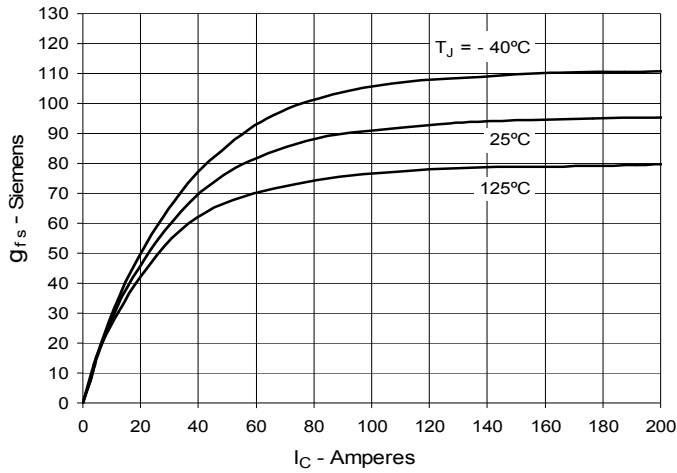
**Fig. 3. Output Characteristics  
@ 125°C**

**Fig. 4. Dependence of  $V_{CE(sat)}$  on  
Junction Temperature**

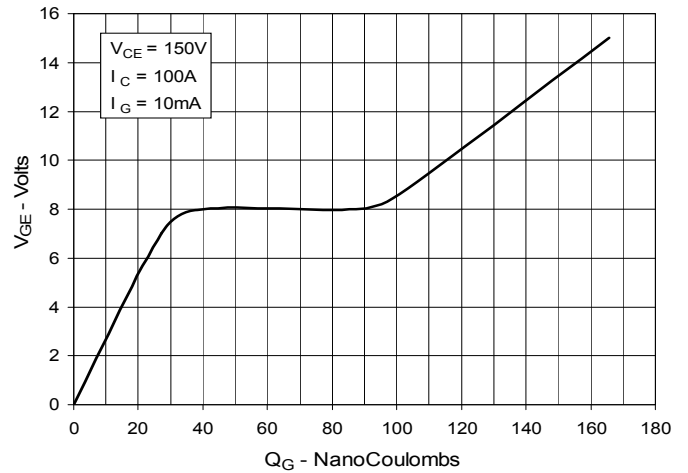
**Fig. 5. Collector-to-Emitter Voltage  
vs. Gate-to-Emitter Voltage**

**Fig. 6. Input Admittance**

**Fig. 7. Transconductance**



**Fig. 8. Gate Charge**



**Fig. 9. Reverse-Bias Safe Operating Area**

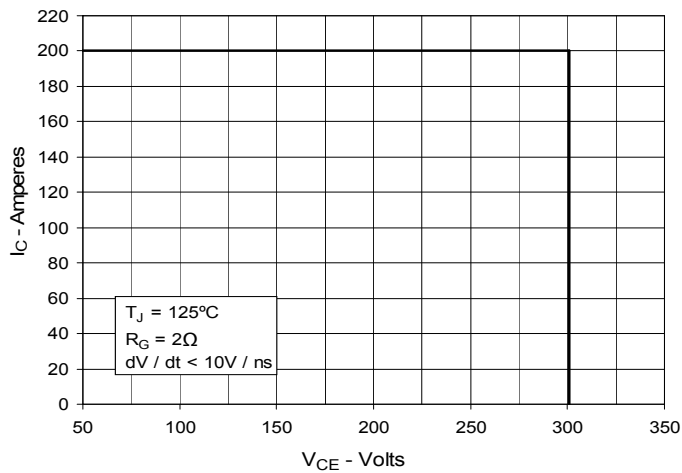

**Fig. 10. Capacitance**

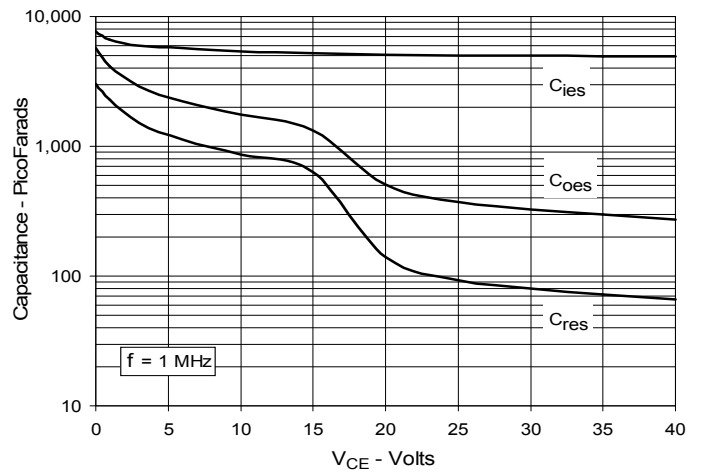

**Fig. 11. Forward-Bias Safe Operating Area**

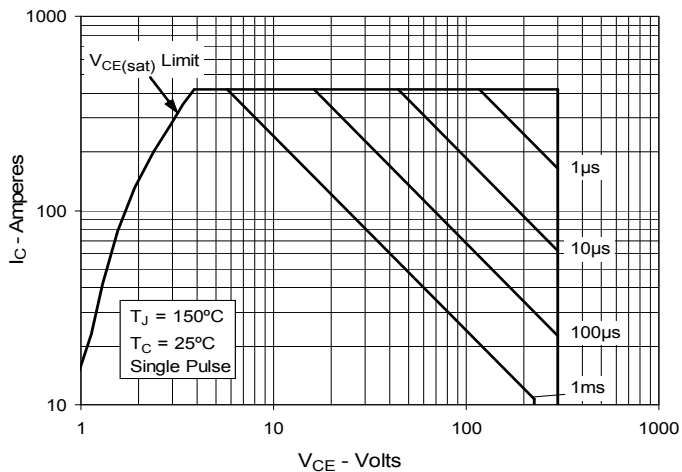

**Fig. 12. Maximum Transient Thermal Impedance**

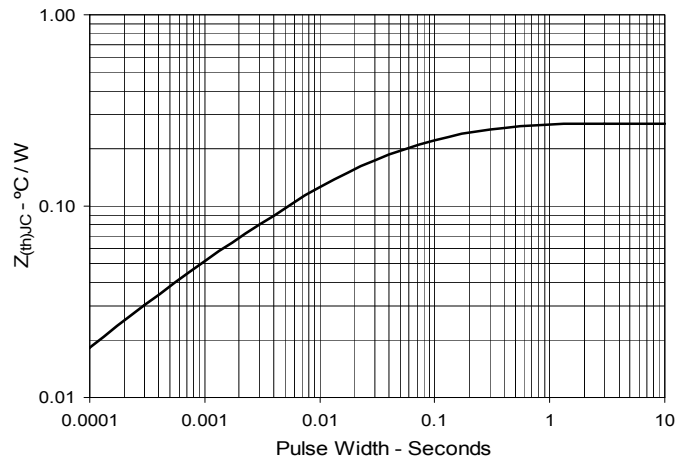

IXYS reserves the right to change limits, test conditions, and dimensions.

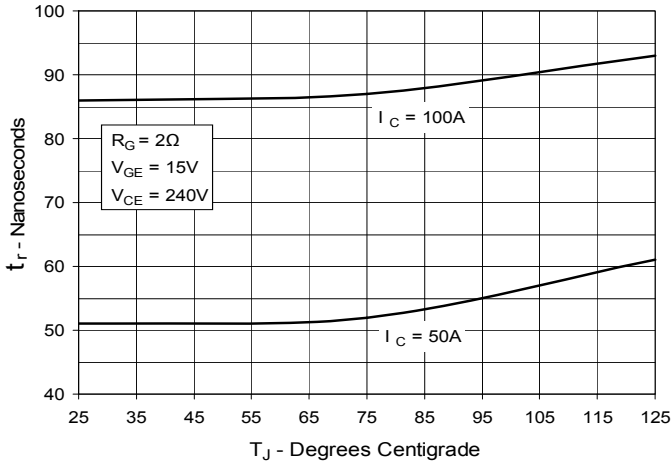
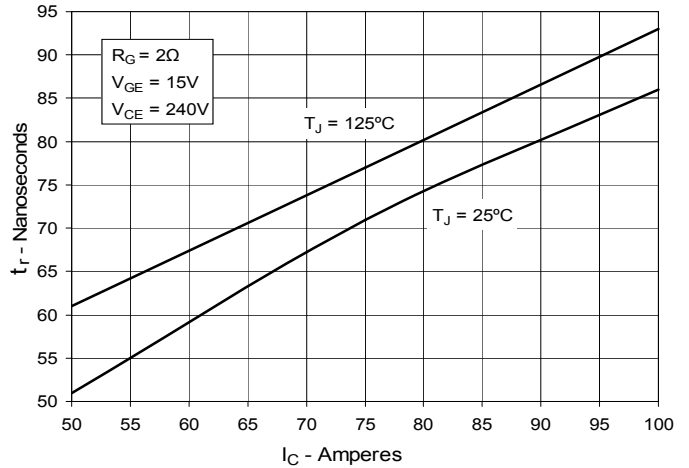
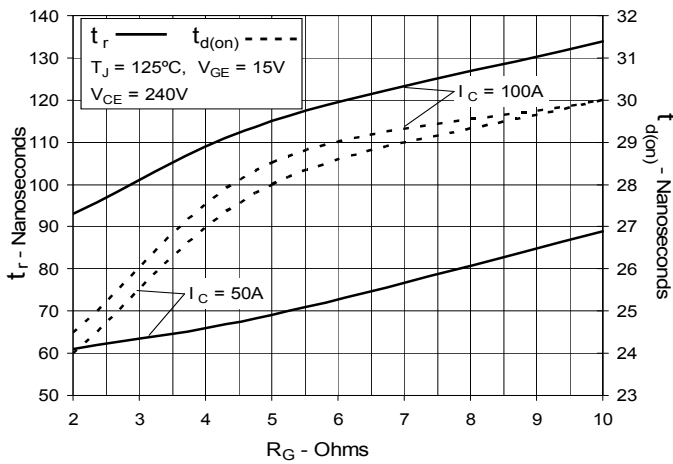
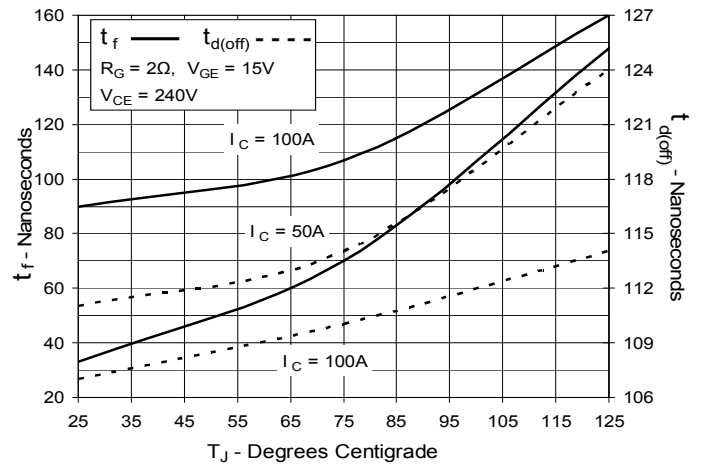
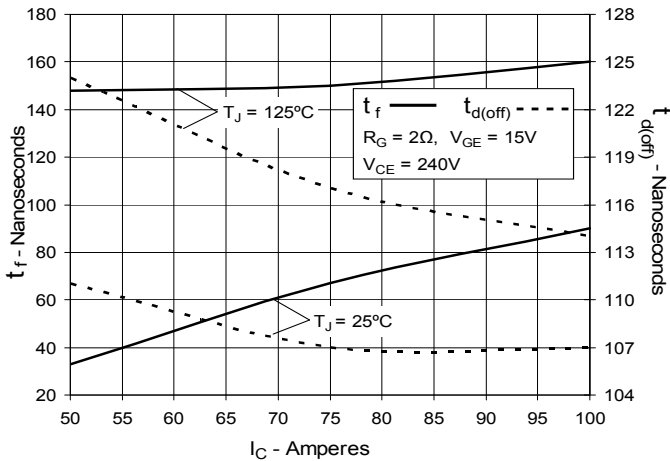
**Fig. 13. Resistive Turn-on Rise Time vs. Junction Temperature**

**Fig. 14. Resistive Turn-on Rise Time vs. Collector Current**

**Fig. 15. Resistive Turn-on Switching Times vs. Gate Resistance**

**Fig. 16. Resistive Turn-off Switching Times vs. Junction Temperature**

**Fig. 17. Resistive Turn-off Switching Times vs. Collector Current**

**Fig. 18. Resistive Turn-off Switching Times vs. Gate Resistance**
