

GenX3™ 1200V IGBTs

IXGA12N120A3
IXGP12N120A3
IXGH12N120A3

$V_{CES} = 1200V$
 $I_{C90} = 12A$
 $V_{CE(sat)} \leq 3.0V$

High Surge Current

Ultra-Low V_{sat} PT IGBTs for up to 3kHz Switching

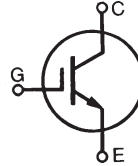

Symbol	Test Conditions	Maximum Ratings	
V_{CES}	$T_J = 25^\circ C$ to $150^\circ C$	1200	V
V_{CGR}	$T_J = 25^\circ C$ to $150^\circ C$, $R_{GE} = 1M\Omega$	1200	V
V_{GES}	Continuous	± 20	V
V_{GEM}	Transient	± 30	V
I_{C25}	$T_C = 25^\circ C$	22	A
I_{C90}	$T_C = 90^\circ C$	12	A
I_{CM}	$T_C = 25^\circ C$, 1ms	60	A
SSOA (RBSOA)	$V_{GE} = 15V$, $T_{VJ} = 125^\circ C$, $R_G = 10\Omega$ Clamped Inductive Load	$I_{CM} = 24$ $V_{CE} \leq 0.8 \cdot V_{CES}$	A
P_C	$T_C = 25^\circ C$	100	W
T_J		-55 ... +150	$^\circ C$
T_{JM}		150	$^\circ C$
T_{stg}		-55 ... +150	$^\circ C$
T_L	Maximum Lead Temperature for Soldering	300	$^\circ C$
T_{SOLD}	1.6 mm (0.062in.) from Case for 10s	260	$^\circ C$
F_C	Mounting Force (TO-263)	10..65 / 2.2..14.6	N/lb.
M_d	Mounting Torque (TO-220 & TO-247)	1.13 / 10	Nm/lb.in.
Weight	TO-263	2.5	g
	TO-220	3.0	g
	TO-247	6.0	g

Symbol	Test Conditions ($T_J = 25^\circ C$, Unless Otherwise Specified)	Characteristic Values		
		Min.	Typ.	Max.
BV_{CES}	$I_C = 250\mu A$, $V_{GE} = 0V$	1200		V
$V_{GE(th)}$	$I_C = 250\mu A$, $V_{CE} = V_{GE}$	2.5		5.0 V
I_{CES}	$V_{CE} = V_{CES}$, $V_{GE} = 0V$ $T_J = 125^\circ C$			10 μA 275 μA
I_{GES}	$V_{CE} = 0V$, $V_{GE} = \pm 20V$			± 100 nA
$V_{CE(sat)}$	$I_C = I_{C90}$, $V_{GE} = 15V$, Note 1 $T_J = 125^\circ C$		2.40 2.75	V V

TO-263 AA (IXGA)

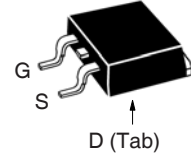

TO-220AB (IXGP)

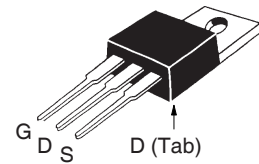

TO-247 (IXGH)

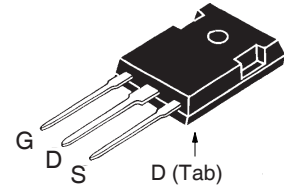

G = Gate D = Drain
S = Source Tab = Drain

Features

- Optimized for Low Conduction Losses
- International Standard Packages

Advantages

- High Power Density
- Low Gate Drive Requirement

Applications

- Power Inverters
- UPS
- Motor Drives
- SMPS
- PFC Circuits
- Battery Chargers
- Welding Machines
- Lamp Ballasts
- Inrush Current Protection Circuits

Symbol	Test Conditions ($T_J = 25^\circ\text{C}$, Unless Otherwise Specified)	Characteristic Values		
		Min.	Typ.	Max.
g_{fs}	$I_C = I_{C90}, V_{CE} = 10\text{V}$, Note 1	5.2	8.8	S
$I_{C(on)}$	$V_{GE} = 10\text{V}, V_{CE} = 10\text{V}$, Note 1		44	A
C_{ies}	$V_{CE} = 25\text{V}, V_{GE} = 0\text{V}, f = 1\text{MHz}$		550	pF
C_{oes}			30	pF
C_{res}			8	pF
Q_g	$I_C = I_{C90}, V_{GE} = 15\text{V}, V_{CE} = 600\text{V}$		20.4	nC
Q_{ge}			3.1	nC
Q_{gc}			8.5	nC
$t_{d(on)}$	Resistive Switching Times, $T_J = 25^\circ\text{C}$ $I_C = I_{C90}, V_{GE} = 15\text{V}$ $V_{CE} = 960\text{V}, R_G = 10\Omega$		35	ns
t_r			140	ns
$t_{d(off)}$			62	ns
t_f			1035	ns
$t_{d(on)}$	Resistive Switching Times, $T_J = 125^\circ\text{C}$ $I_C = I_{C90}, V_{GE} = 15\text{V}$ $V_{CE} = 960\text{V}, R_G = 10\Omega$		35	ns
t_r			167	ns
$t_{d(off)}$			70	ns
t_f			1475	ns
R_{thJC}				1.25 $^\circ\text{C/W}$
R_{thCS}	TO-247		0.21	$^\circ\text{C/W}$
	TO-220		0.50	$^\circ\text{C/W}$

TO-263 Outline

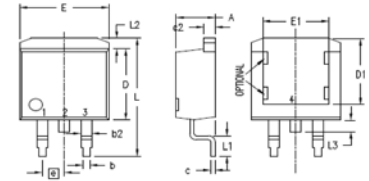

- 1 = Gate
- 2 = Collector
- 3 = Emitter
- 4 = Collector

SYM	INCHES		MILLIMETERS	
	MIN	MAX	MIN	MAX
A	.160	.190	4.06	4.83
A1	.080	.110	2.03	2.79
b	.020	.039	0.51	0.99
b2	.045	.055	1.14	1.40
c	.016	.029	0.40	0.74
c2	.045	.055	1.14	1.40
D	.340	.380	8.64	9.65
D1	.315	.350	8.00	8.89
E	.380	.410	9.65	10.41
E1	.245	.320	6.22	8.13
e	.100 BSC		2.54 BSC	
L	.575	.625	14.61	15.88
L1	.090	.110	2.29	2.79
L2	.040	.055	1.02	1.40
L3	.050	.070	1.27	1.78
L4	0	.005	0	0.13

Note 1. Pulse test, $t \leq 300\mu\text{s}$, duty cycle, $d \leq 2\%$.

TO-247 Outline

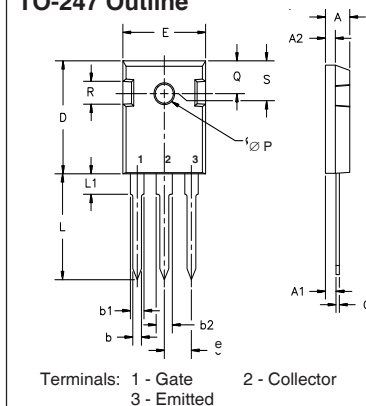

Dim.	Millimeter		Inches	
	Min.	Max.	Min.	Max.
A	4.7	5.3	.185	.209
A ₁	2.2	2.54	.087	.102
A ₂	2.2	2.6	.059	.098
b	1.0	1.4	.040	.055
b ₁	1.65	2.13	.065	.084
b ₂	2.87	3.12	.113	.123
C	.4	.8	.016	.031
D	20.80	21.46	.819	.845
E	15.75	16.26	.610	.640
e	5.20	5.72	0.205	0.225
L	19.81	20.32	.780	.800
L1		4.50		.177
∅P	3.55	3.65	.140	.144
Q	5.89	6.40	0.232	0.252
R	4.32	5.49	.170	.216
S	6.15	BSC	242	BSC

TO-220 Outline

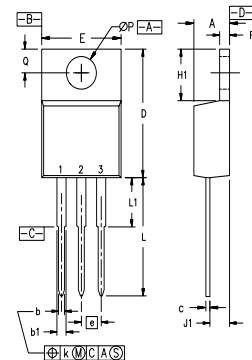

- 1 = Gate
- 2 = Collector
- 3 = Emitter

SYM	INCHES		MILLIMETERS	
	MIN	MAX	MIN	MAX
A	.170	.190	4.32	4.83
b	.025	.040	0.64	1.02
b1	.045	.065	1.15	1.65
c	.014	.022	0.35	0.56
D	.580	.630	14.73	16.00
E	.390	.420	9.91	10.66
e	.100 BSC		2.54 BSC	
F	.045	.055	1.14	1.40
H1	.230	.270	5.85	6.85
J1	.090	.110	2.29	2.79
k	0	.015	0	0.38
L	.500	.550	12.70	13.97
L1	.110	.230	2.79	5.84
∅P	.139	.161	3.53	4.08
Q	.100	.125	2.54	3.18

IXYS Reserves the Right to Change Limits, Test Conditions, and Dimensions.

IXYS MOSFETs and IGBTs are covered by one or more of the following U.S. patents:	4,835,592	4,931,844	5,049,961	5,237,481	6,162,665	6,404,065 B1	6,683,344	6,727,585	7,005,734 B2	7,157,338B2
	4,850,072	5,017,508	5,063,307	5,381,025	6,259,123 B1	6,534,343	6,710,405 B2	6,759,692	7,063,975 B2	
	4,881,106	5,034,796	5,187,117	5,486,715	6,306,728 B1	6,583,505	6,710,463	6,771,478 B2	7,071,537	

Fig. 1. Output Characteristics @ $T_J = 25^\circ\text{C}$

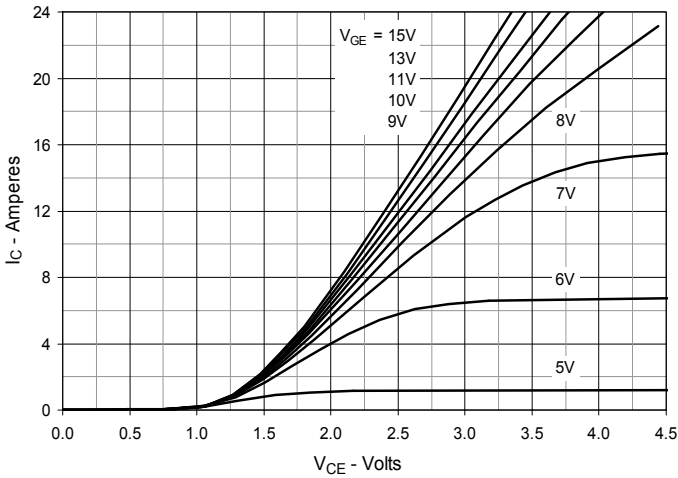

Fig. 2. Extended Output Characteristics @ $T_J = 25^\circ\text{C}$

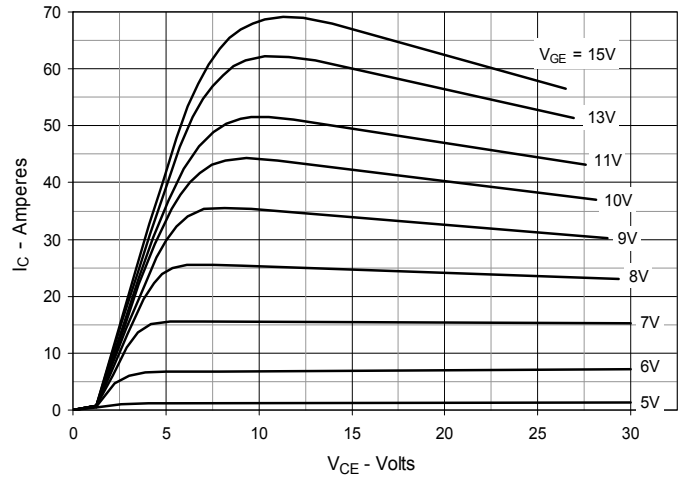

Fig. 3. Output Characteristics @ $T_J = 125^\circ\text{C}$

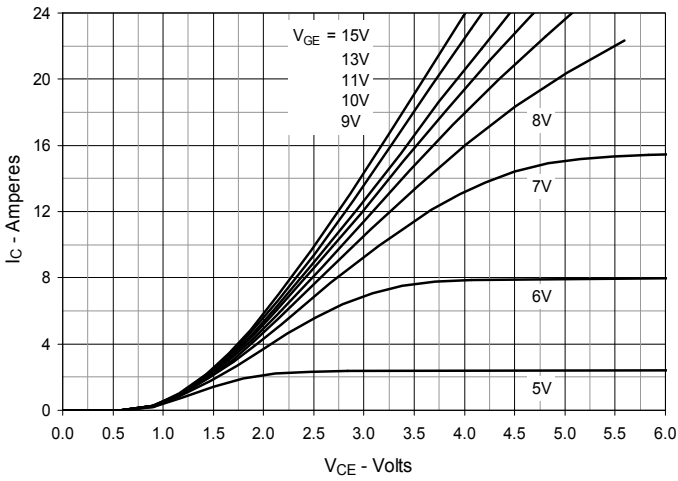

Fig. 4. Dependence of $V_{CE(sat)}$ on Junction Temperature

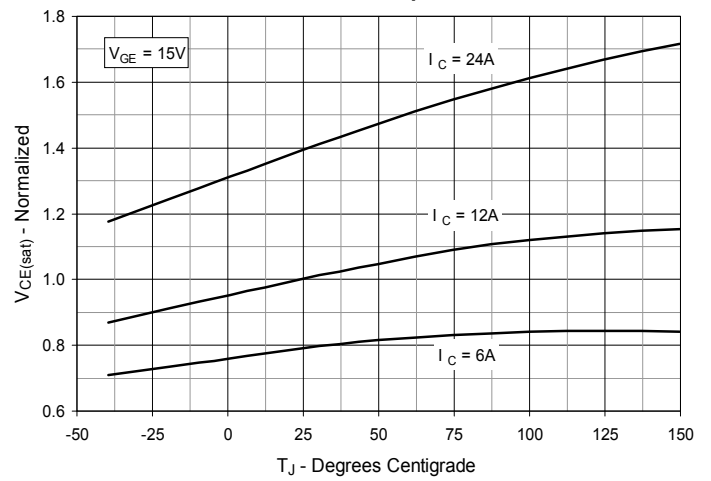

Fig. 5. Collector-to-Emitter Voltage vs. Gate-to-Emitter Voltage

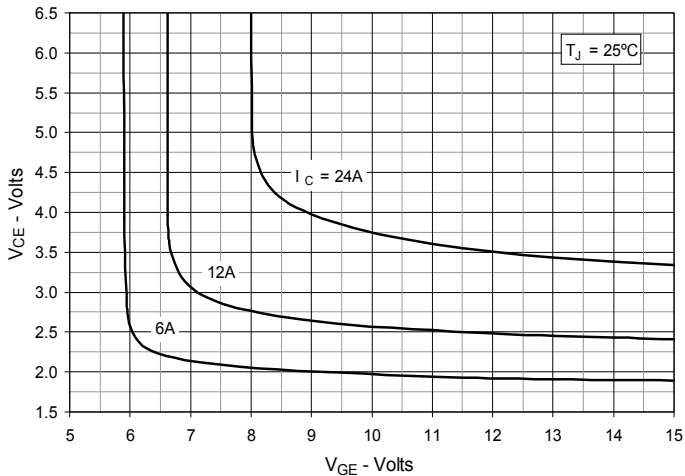

Fig. 6. Input Admittance

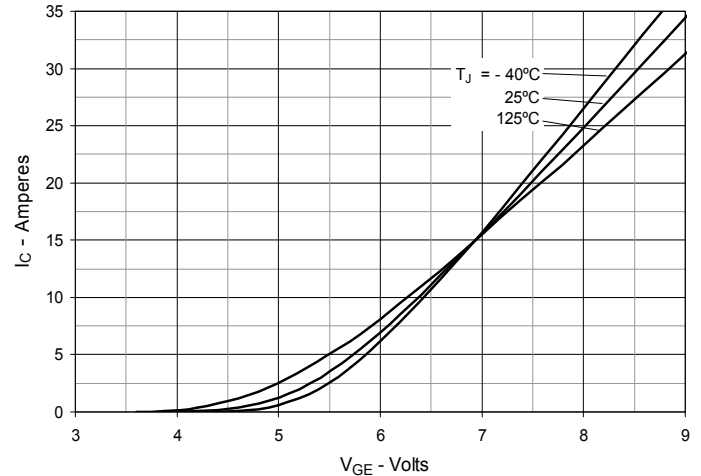

Fig. 7. Transconductance

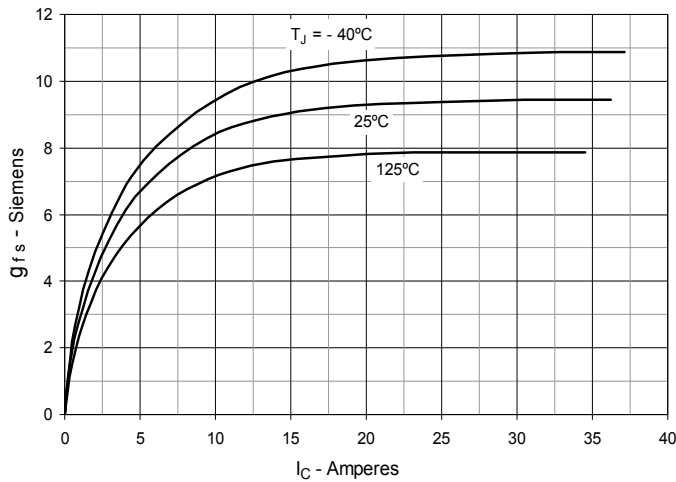

Fig. 8. Gate Charge

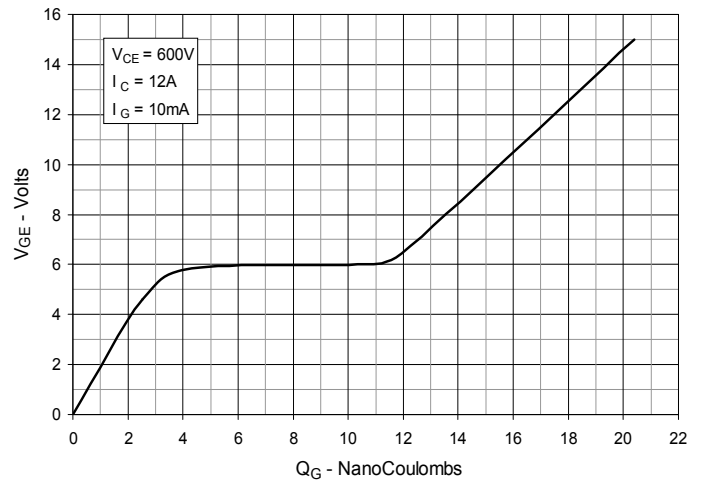

Fig. 9. Reverse-Bias Safe Operating Area

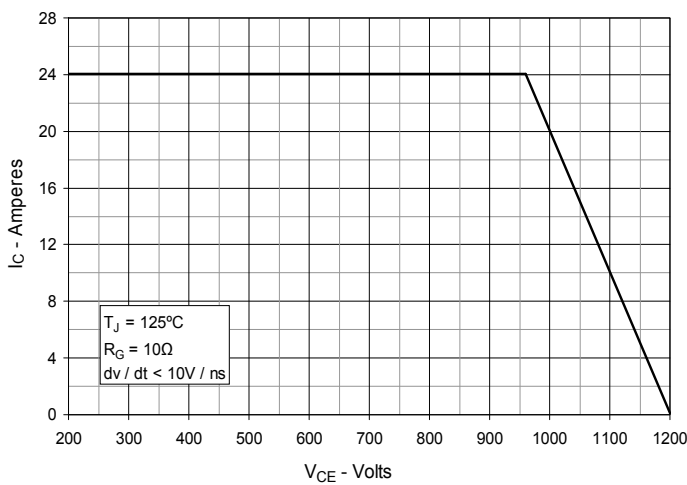

Fig. 10. Capacitance

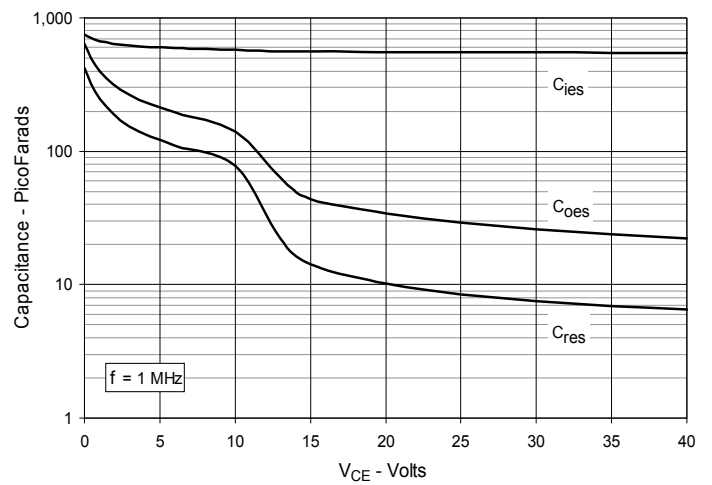

Fig. 11. Maximum Transient Thermal Impedance

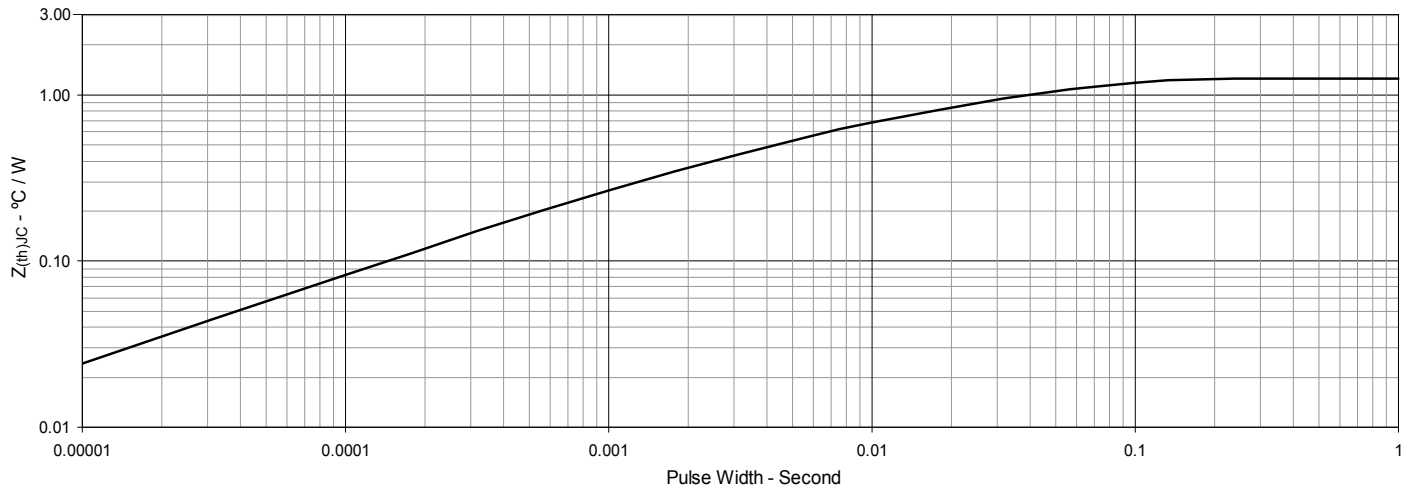

Fig. 12. Resistive Turn-on Rise Time vs. Junction Temperature

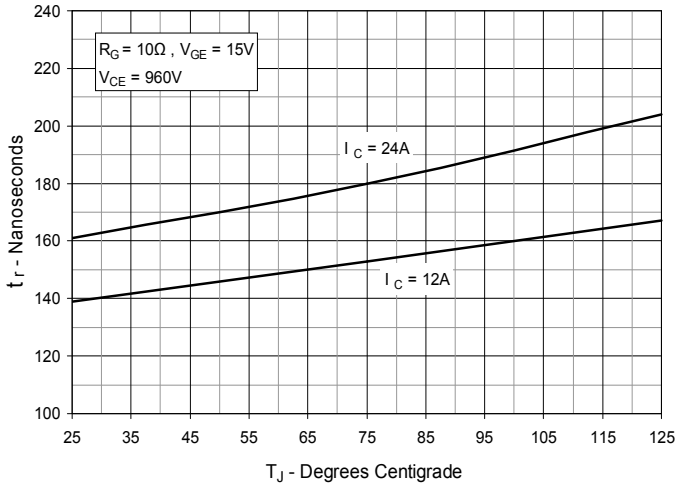

Fig. 13. Resistive Turn-on Rise Time vs. Collector Current

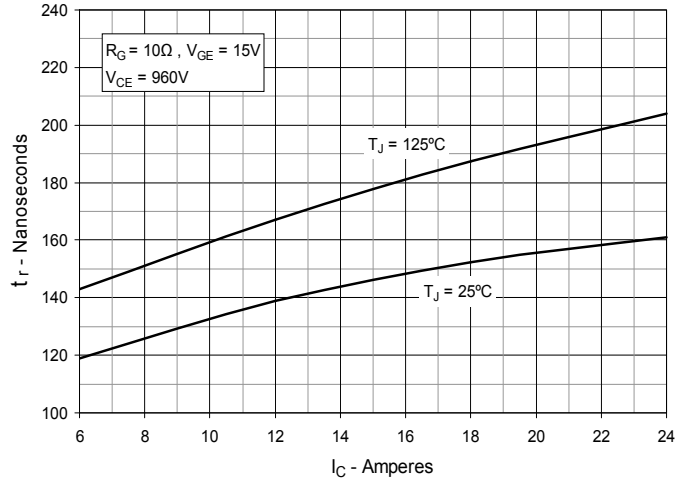

Fig. 14. Resistive Turn-on Switching Times vs. Gate Resistance

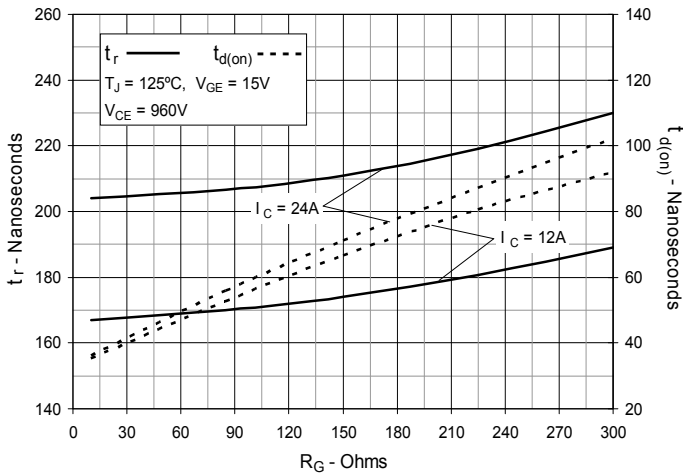

Fig. 15. Resistive Turn-off Switching Times vs. Junction Temperature

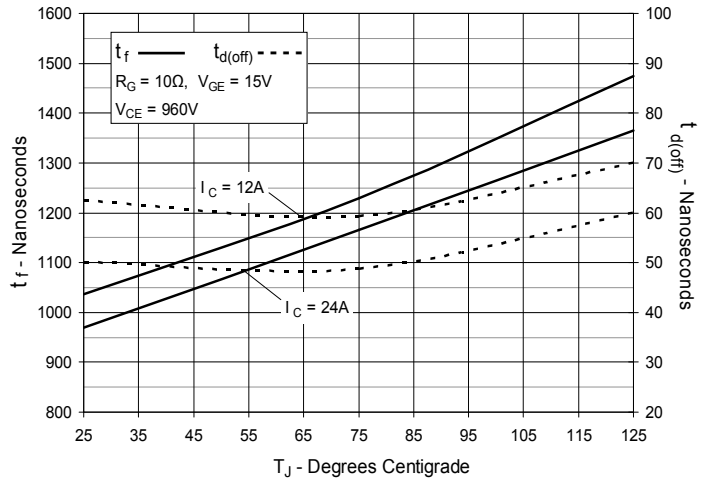

Fig. 16. Resistive Turn-off Switching Times vs. Collector Current

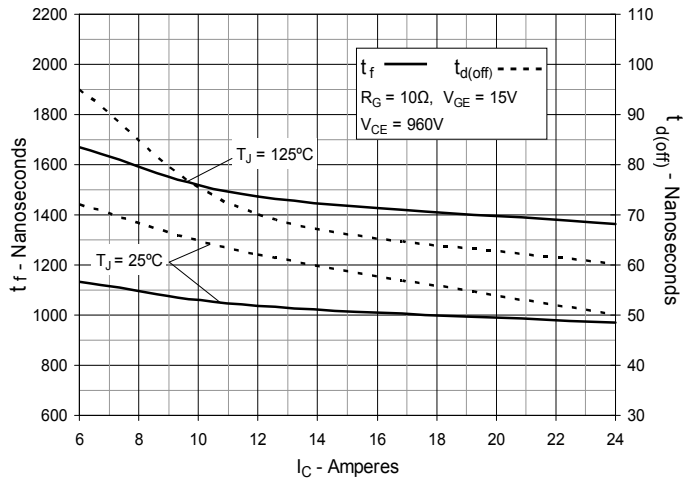

Fig. 17. Resistive Turn-off Switching Times vs. Gate Resistance

