

HiPerFAST™ IGBT

IXGH 20N60B
IXGT 20N60B

$V_{CES} = 600 \text{ V}$
 $I_{C25} = 40 \text{ A}$
 $V_{CE(sat)typ} = 1.7 \text{ V}$
 $t_{fi(typ)} = 100 \text{ ns}$

Preliminary data sheet

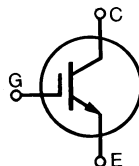

Symbol	Test Conditions	Maximum Ratings	
V_{CES}	$T_J = 25^\circ\text{C to } 150^\circ\text{C}$	600	V
V_{CGR}	$T_J = 25^\circ\text{C to } 150^\circ\text{C}; R_{GE} = 1 \text{ M}\Omega$	600	V
V_{GES}	Continuous	± 20	V
V_{GEM}	Transient	± 30	V
I_{C25}	$T_C = 25^\circ\text{C}$	40	A
I_{C90}	$T_C = 90^\circ\text{C}$	20	A
I_{CM}	$T_C = 25^\circ\text{C}, 1 \text{ ms}$	80	A
SSOA (RBSOA)	$V_{GE} = 15 \text{ V}, T_{VJ} = 125^\circ\text{C}, R_G = 22 \Omega$ Clamped inductive load, $L = 100 \mu\text{H}$	$I_{CM} = 40$ @ $0.8 V_{CES}$	A
P_C	$T_C = 25^\circ\text{C}$	150	W
T_J		-55 ... +150	$^\circ\text{C}$
T_{JM}		150	$^\circ\text{C}$
T_{stg}		-55 ... +150	$^\circ\text{C}$
Maximum Lead and Tab temperature for soldering 1.6 mm (0.062 in.) from case for 10 s		300	$^\circ\text{C}$
M_d	Mounting torque, TO-247 AD	1.13/10	Nm/lb.in.
Weight	TO-247	6	g
	TO-268	4	g

TO-268 (D3) (IXGT)

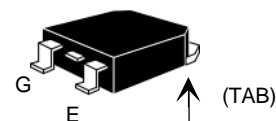

TO-247 AD (IXGH)

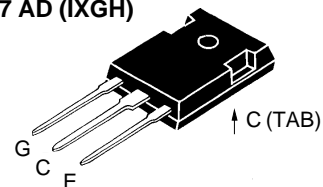

G = Gate, C = Collector,
E = Emitter, TAB = Collector

Features

- International standard packages JEDEC TO-268 surface mountable and JEDEC TO-247 AD
- High current handling capability
- Latest generation HDMOS™ process
- MOS Gate turn-on - drive simplicity

Applications

- AC motor speed control
- DC servo and robot drives
- DC choppers
- Uninterruptible power supplies (UPS)
- Switched-mode and resonant-mode power supplies

Advantages

- Space savings (two devices in one package)
- High power density
- Suitable for surface mounting
- Switching speed for high frequency applications
- Easy to mount with 1 screw, TO-247 (isolated mounting screw hole)

Symbol	Test Conditions	Characteristic Values ($T_J = 25^\circ\text{C}$, unless otherwise specified)		
		min.	typ.	max.
BV_{CES}	$I_C = 250 \mu\text{A}, V_{GE} = 0 \text{ V}$	600		V
$V_{GE(th)}$	$I_C = 250 \mu\text{A}, V_{CE} = V_{GE}$	2.5		V
I_{CES}	$V_{CE} = 0.8 \cdot V_{CES}$ $V_{GE} = 0 \text{ V}$			$T_J = 25^\circ\text{C}$ $T_J = 125^\circ\text{C}$ 200 μA 1 mA
I_{GES}	$V_{CE} = 0 \text{ V}, V_{GE} = \pm 20 \text{ V}$			$\pm 100 \text{ nA}$
$V_{CE(sat)}$	$I_C = I_{C90}, V_{GE} = 15 \text{ V}$	1.7	2.0	V

Symbol	Test Conditions	Characteristic Values ($T_J = 25^\circ\text{C}$, unless otherwise specified)		
		min.	typ.	max.
g_{fs}	$I_C = I_{C90}$, $V_{CE} = 10\text{ V}$, Pulse test, $t \leq 300\ \mu\text{s}$, duty cycle $\leq 2\%$	9	17	S
C_{ies} C_{oes} C_{res}	$V_{CE} = 25\text{ V}$, $V_{GE} = 0\text{ V}$, $f = 1\text{ MHz}$		1500	pF
			175	pF
			40	pF
Q_g Q_{ge} Q_{gc}	$I_C = I_{C90}$, $V_{GE} = 15\text{ V}$, $V_{CE} = 0.5 V_{CES}$		90	nC
			11	nC
			30	nC
$t_{d(on)}$ t_{ri} E_{on} $t_{d(off)}$ t_{fi} E_{off}	Inductive load, $T_J = 25^\circ\text{C}$ $I_C = I_{C90}$, $V_{GE} = 15\text{ V}$, $L = 100\ \mu\text{H}$, $V_{CE} = 0.8 V_{CES}$, $R_G = R_{off} = 10\ \Omega$ Note 1	15 35 0.15 150 100 0.7	200 150 1.0	ns ns mJ ns ns mJ
$t_{d(on)}$ t_{ri} E_{on} $t_{d(off)}$ t_{fi} E_{off}	Inductive load, $T_J = 125^\circ\text{C}$ $I_C = I_{C90}$, $V_{GE} = 15\text{ V}$, $L = 100\ \mu\text{H}$, $V_{CE} = 0.8 V_{CES}$, $R_G = R_{off} = 10\ \Omega$ Note 1	15 35 0.15 220 140 1.2		ns ns mJ ns ns mJ
R_{thJC} R_{thCK}		0.25		0.83 K/W K/W

Note 1: Switching times may increase for V_{CE} (Clamp) $> 0.8 \cdot V_{CES}$, higher T_J or increased R_G

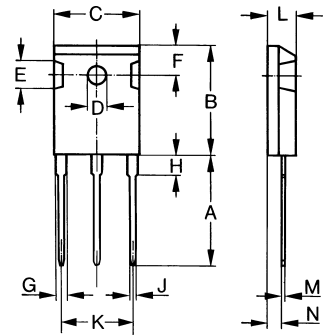
TO-247 AD (IXGH) Outline

Dim.	Millimeter		Inches	
	Min.	Max.	Min.	Max.
A	19.81	20.32	0.780	0.800
B	20.80	21.46	0.819	0.845
C	15.75	16.26	0.610	0.640
D	3.55	3.65	0.140	0.144
E	4.32	5.49	0.170	0.216
F	5.4	6.2	0.212	0.244
G	1.65	2.13	0.065	0.084
H	-	4.5	-	0.177
J	1.0	1.4	0.040	0.055
K	10.8	11.0	0.426	0.433
L	4.7	5.3	0.185	0.209
M	0.4	0.8	0.016	0.031
N	1.5	2.49	0.087	0.102

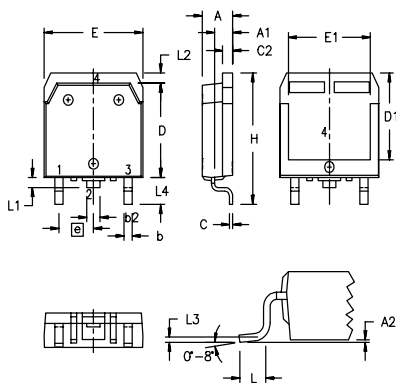
TO-268AA (D³ PAK)

Dim.	Millimeter		Inches	
	Min.	Max.	Min.	Max.
A	4.9	5.1	.193	.201
A ₁	2.7	2.9	.106	.114
A ₂	.02	.25	.001	.010
b	1.15	1.45	.045	.057
b ₂	1.9	2.1	.75	.83
C	.4	.65	.016	.026
D	13.80	14.00	.543	.551
E	15.85	16.05	.624	.632
E ₁	13.3	13.6	.524	.535
e	5.45 BSC		.215 BSC	
H	18.70	19.10	.736	.752
L	2.40	2.70	.094	.106
L1	1.20	1.40	.047	.055
L2	1.00	1.15	.039	.045
L3	0.25 BSC		.010 BSC	
L4	3.80	4.10	.150	.161

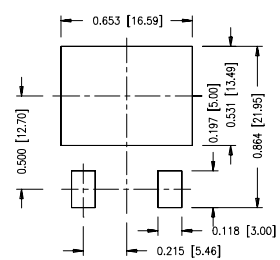
Min. Recommended Footprint

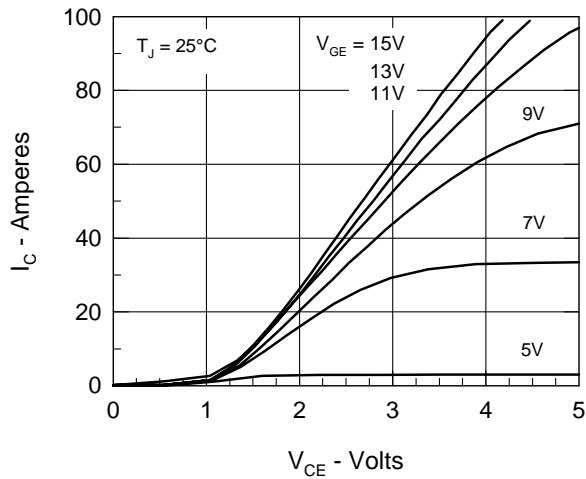

Fig. 1. Output Characteristics

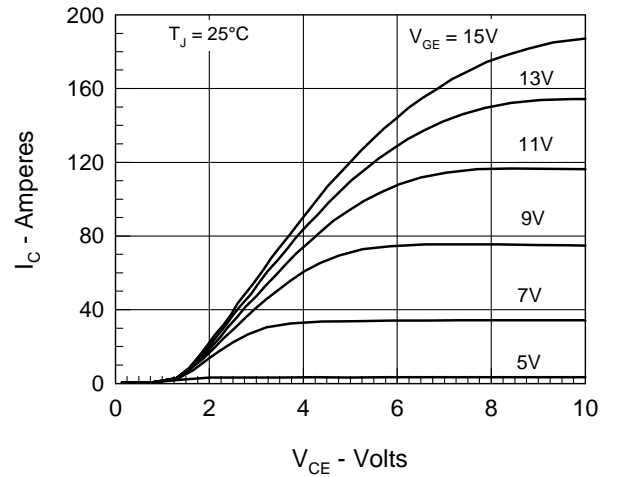

Fig. 2. Extended Output Characteristics

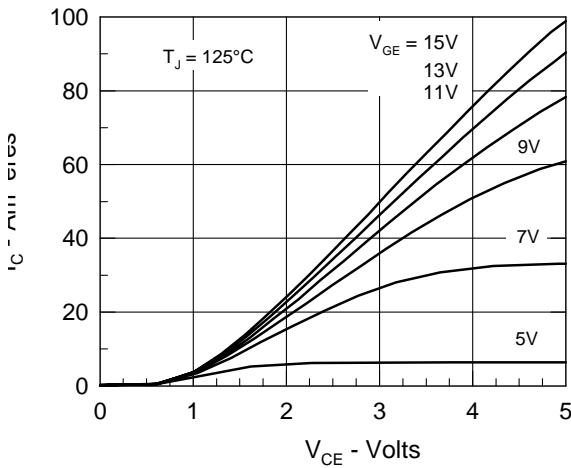

Fig. 3. High Temperature Output Characteristics

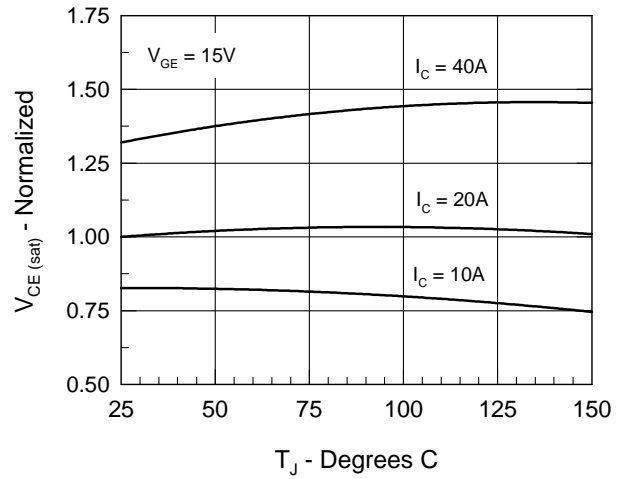

Fig. 4. Temperature Dependence of $V_{CE(sat)}$

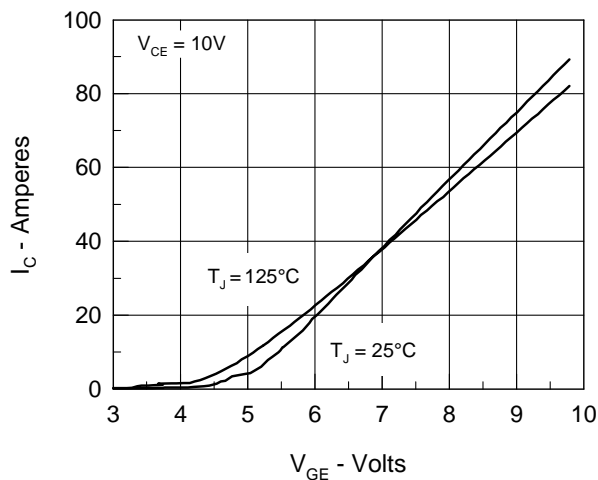

Fig. 5. Admittance Curves

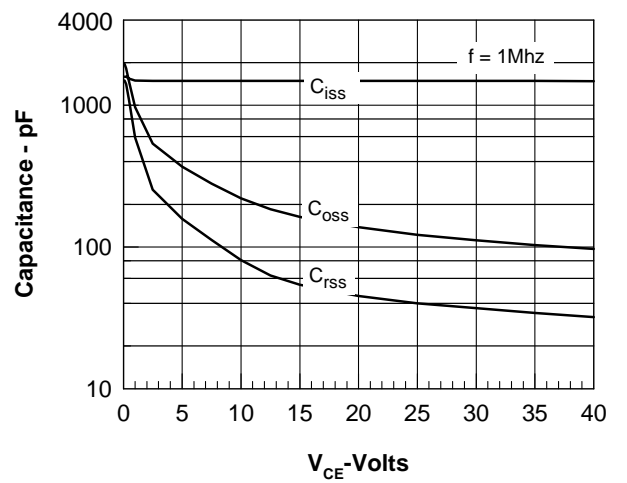

Fig. 6. Capacitance Curves

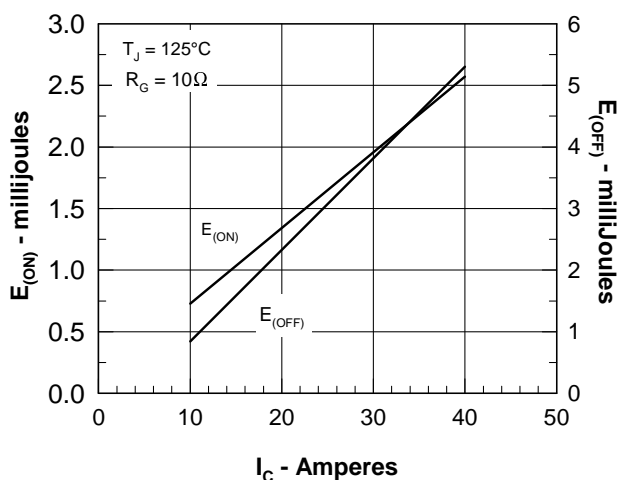

Fig. 7. Dependence of E_{ON} and E_{OFF} on I_C .

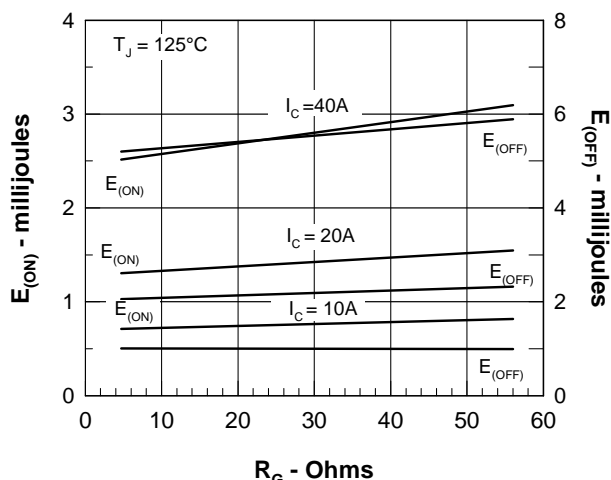

Fig. 8. Dependence of E_{ON} and E_{OFF} on R_G .

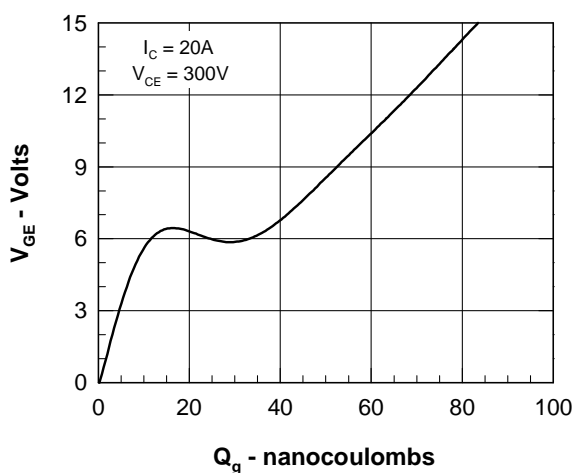

Fig. 9. Gate Charge

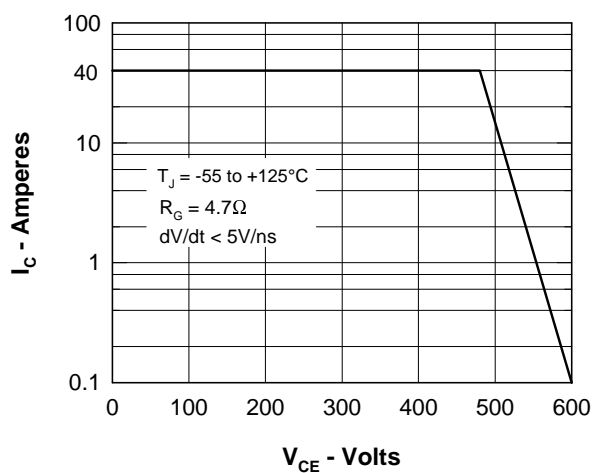

Fig. 10. Turn-off Safe Operating Area

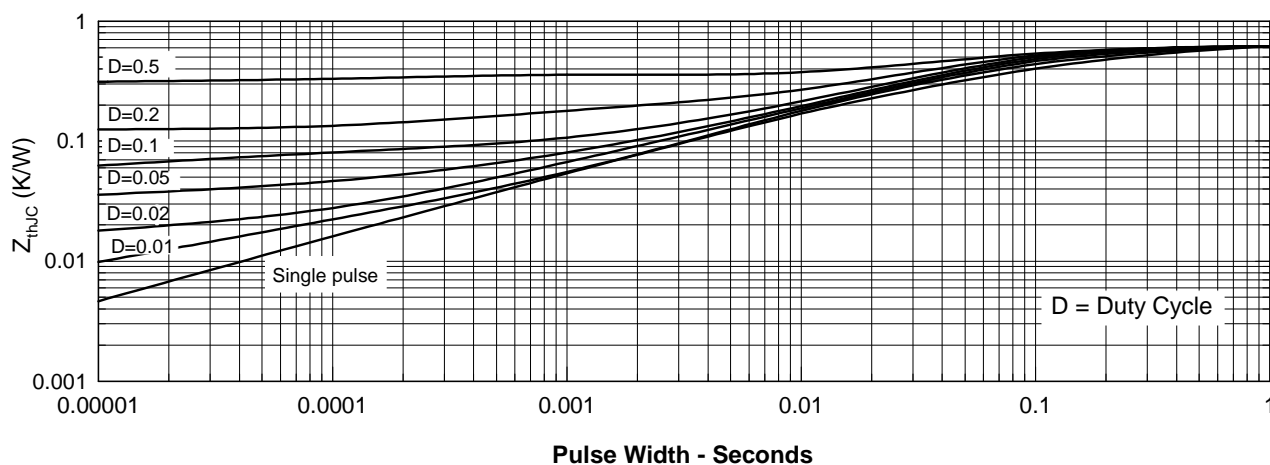

Fig. 11. IGBT Transient Thermal Resistance Junction-to-Case