

# High Voltage IGBT For Capacitor Discharge Applications

**IXGH25N250**  
**IXGT25N250**  
**IXGV25N250S**

$$V_{CES} = 2500 \text{ V}$$

$$I_{C25} = 60 \text{ A}$$

$$V_{CE(sat)} \leq 2.9 \text{ V}$$

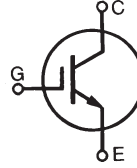

Symbol	Test Conditions	Maximum Ratings	
$V_{CES}$	$T_J = 25^\circ\text{C to } 150^\circ\text{C}$	2500	V
$V_{CGR}$	$T_J = 25^\circ\text{C to } 150^\circ\text{C}; R_{GE} = 1 \text{ M}\Omega$	2500	V
$V_{GES}$	Continuous	$\pm 20$	V
$V_{GEM}$	Transient	$\pm 30$	V
$I_{C25}$	$T_C = 25^\circ\text{C}$	60	A
$I_{C110}$	$T_C = 110^\circ\text{C}$	25	A
$I_{CM}$	$T_C = 25^\circ\text{C}, V_{GE} = 20 \text{ V}, 1 \text{ ms}$	200	A
<b>SSOA</b> <b>(RBSOA)</b>	$V_{GE} = 20 \text{ V}, T_J = 125^\circ\text{C}, R_G = 20 \Omega$ Clamped inductive load @ 1250V	$I_{CM} = 240$	A
$P_C$	$T_C = 25^\circ\text{C}$	250	W
$T_J$		-55 ... +150	$^\circ\text{C}$
$T_{JM}$		150	$^\circ\text{C}$
$T_{stg}$		-55 ... +150	$^\circ\text{C}$
$T_L$	1.6 mm (0.062 in.) from case for 10 s	300	$^\circ\text{C}$
$T_{SOLD}$	Plastic body for 10 s	260	$^\circ\text{C}$
$M_d$	Mounting torque (TO-247)	1.13/10	Nm/lb-in
<b>Weight</b>		TO-247	6 g
		TO-268	4 g

Symbol	Test Conditions	Characteristic Values ( $T_J = 25^\circ\text{C}$ unless otherwise specified)		
		Min.	Typ.	Max.
$BV_{CES}$	$I_C = 250 \mu\text{A}, V_{GE} = 0 \text{ V}$	2500		V
$V_{GE(th)}$	$I_C = 250 \mu\text{A}, V_{CE} = V_{GE}$	3.0		5.0 V
$I_{CES}$	$V_{CE} = 0.8 \cdot V_{CES}$ $V_{GE} = 0 \text{ V}$ $T_J = 125^\circ\text{C}$			50 $\mu\text{A}$ 1 mA
$I_{GES}$	$V_{CE} = 0 \text{ V}, V_{GE} = \pm 20 \text{ V}$			$\pm 100 \text{ nA}$
$V_{CE(sat)}$	$I_C = 25 \text{ A}, V_{GE} = 15 \text{ V}$			2.9 V
	$I_C = 75 \text{ A}$			5.2 V

TO-247 (IXGH)

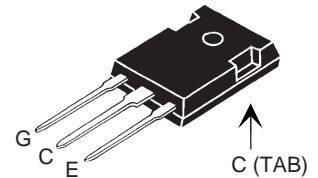

TO-268 (IXGT)

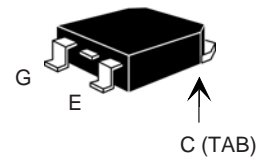

PLUS220SMD (IXGV...S)

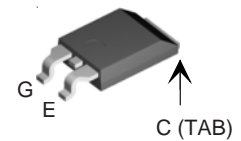

G = Gate, C = Collector,  
E = Emitter, TAB = Collector

## Features

- High peak current capability
- Low saturation voltage
- MOS Gate turn-on -drive simplicity
- Rugged NPT structure
- Molding epoxies meet UL 94 V-0 flammability classification

## Applications

- Capacitor discharge
- Pulser circuits

## Advantages

- High power density
- Suitable for surface mounting
- Easy to mount with 1 screw, (isolated mounting screw hole)

Symbol	Test Conditions	Characteristic Values ( $T_J = 25^\circ\text{C}$ unless otherwise specified)		
		Min.	Typ.	Max.
$g_{fs}$	$I_C = 50\text{ A}$ ; $V_{CE} = 10\text{ V}$ , Note 1	16	26	S
$I_{C(ON)}$	$V_{GE} = 15\text{ V}$ , $V_{CE} = 20\text{ V}$ , Note 1		240	A
$C_{ies}$	$V_{CE} = 25\text{ V}$ , $V_{GE} = 0\text{ V}$ , $f = 1\text{ MHz}$		2310	pF
$C_{oes}$			75	pF
$C_{res}$			23	pF
$Q_g$	$I_C = 50\text{ A}$ , $V_{GE} = 15\text{ V}$ , $V_{CE} = 0.5 V_{CES}$		75	nC
$Q_{ge}$			15	nC
$Q_{gc}$			30	nC
$t_{d(on)}$	<b>Resistive load</b>		68	ns
$t_{ri}$	$I_C = 50\text{ A}$ , $V_{GE} = 15\text{ V}$ , Note 1		233	ns
$t_{d(off)}$	$V_{CE} = 1250\text{ V}$ , $R_G = 5\ \Omega$		209	ns
$t_{fi}$			200	ns
$R_{thJC}$			0.5	$^\circ\text{C/W}$
$R_{thCS}$	(TO-247)	0.25		$^\circ\text{C/W}$

- Notes: 1. Pulse test,  $t \leq 300\ \mu\text{s}$ , duty cycle,  $d \leq 2\%$   
 2. Additional provisions for lead-to-lead voltage isolation are required at  $V_{CE} > 1200\text{ V}$

### TO-247 (IXGH) Outline

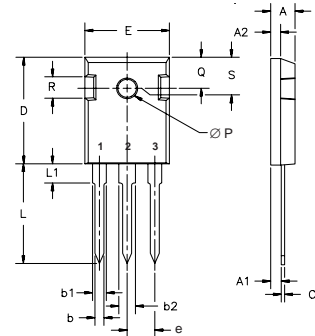

Terminals: 1 - Gate 2 - Drain (Collector)  
 3 - Source (Emitter) Tab - Drain (Collector)

Dim.	Millimeter		Inches	
	Min.	Max.	Min.	Max.
A	4.7	5.3	.185	.209
A <sub>1</sub>	2.2	2.54	.087	.102
A <sub>2</sub>	2.2	2.6	.059	.098
b	1.0	1.4	.040	.055
b <sub>1</sub>	1.65	2.13	.065	.084
b <sub>2</sub>	2.87	3.12	.113	.123
C	.4	.8	.016	.031
D	20.80	21.46	.819	.845
E	15.75	16.26	.610	.640
e	5.20	5.72	0.205	0.225
L	19.81	20.32	.780	.800
L <sub>1</sub>		4.50		.177
∅P	3.55	3.65	.140	.144
Q	5.89	6.40	0.232	0.252
R	4.32	5.49	.170	.216
S	6.15	BSC	242	BSC

### PLUS220SMD (IXGV\_S) Outline

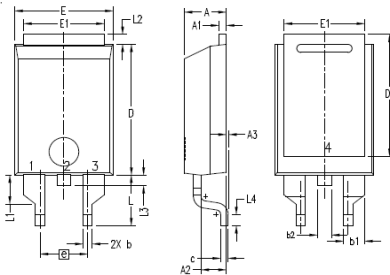

1. GATE  
 2. DRAIN (COLLECTOR)  
 3. SOURCE (EMITTER)  
 4. DRAIN (COLLECTOR)

SYM	INCHES		MILLIMETER	
	MIN	MAX	MIN	MAX
A	.169	.185	4.30	4.70
A <sub>1</sub>	.028	.035	0.70	0.90
A <sub>2</sub>	.098	.118	2.50	3.00
A <sub>3</sub>	.000	.010	0.00	0.25
b	.035	.047	0.90	1.20
b <sub>1</sub>	.080	.095	2.03	2.41
b <sub>2</sub>	.054	.064	1.37	1.63
c	.028	.035	0.70	0.90
D	.551	.591	14.00	15.00
D <sub>1</sub>	.512	.539	13.00	13.70
E	.394	.433	10.00	11.00
E <sub>1</sub>	.331	.346	8.40	8.80
e	.200 BSC		5.08 BSC	
L	.209	.228	5.30	5.80
L <sub>1</sub>	.118	.138	3.00	3.50
L <sub>2</sub>	.035	.051	0.90	1.30
L <sub>3</sub>	.047	.059	1.20	1.50
L <sub>4</sub>	.039	.059	1.00	1.50

### TO-268 (IXGT) Outline (D3-Pak)

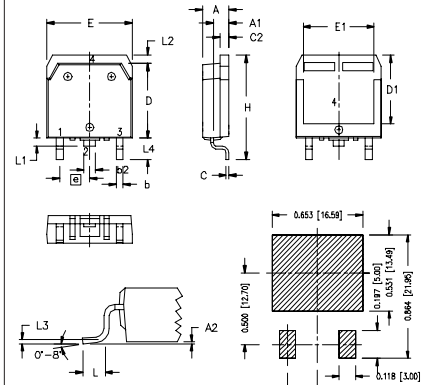

- 1 - GATE  
 2 - DRAIN (COLLECTOR)  
 3 - SOURCE (EMITTER)  
 4 - DRAIN (COLLECTOR)

SYM	INCHES		MILLIMETERS	
	MIN	MAX	MIN	MAX
A	.193	.201	4.90	5.10
A <sub>1</sub>	.106	.114	2.70	2.90
A <sub>2</sub>	.001	.010	0.02	0.25
b	.045	.057	1.15	1.45
b <sub>2</sub>	.075	.083	1.90	2.10
C	.016	.026	0.40	0.65
C <sub>2</sub>	.057	.063	1.45	1.60
D	.543	.551	13.80	14.00
D <sub>1</sub>	.488	.500	12.40	12.70
E	.624	.632	15.85	16.05
E <sub>1</sub>	.524	.535	13.30	13.60
e	.215 BSC		5.45 BSC	
H	.736	.752	18.70	19.10
L	.094	.106	2.40	2.70
L <sub>1</sub>	.047	.055	1.20	1.40
L <sub>2</sub>	.039	.045	1.00	1.15
L <sub>3</sub>	.010 BSC		0.25 BSC	
L <sub>4</sub>	.150	.161	3.80	4.10

Ref: IXYS CO 0052 RA

### PRELIMINARY TECHNICAL INFORMATION

The product presented herein is under development. The Technical Specifications offered are derived from data gathered during objective characterizations of preliminary engineering lots; but also may yet contain some information supplied during a pre-production design evaluation. IXYS reserves the right to change limits, test conditions, and dimensions without notice.

IXYS reserves the right to change limits, test conditions, and dimensions.

IXYS MOSFETs and IGBTs are covered 4,835,592 4,931,844 5,049,961 5,237,481 6,162,665 6,404,065 B1 6,683,344 6,727,585 7,005,734 B2 7,157,338 B2  
 by one or more of the following U.S. patents: 4,850,072 5,017,508 5,063,307 5,381,025 6,259,123 B1 6,534,343 6,710,405 B2 6,759,692 7,063,975 B2  
 4,881,106 5,034,796 5,187,117 5,486,715 6,306,728 B1 6,583,505 6,710,463 6,771,478 B2 7,071,537

**Fig. 1. Output Characteristics @ 25°C**

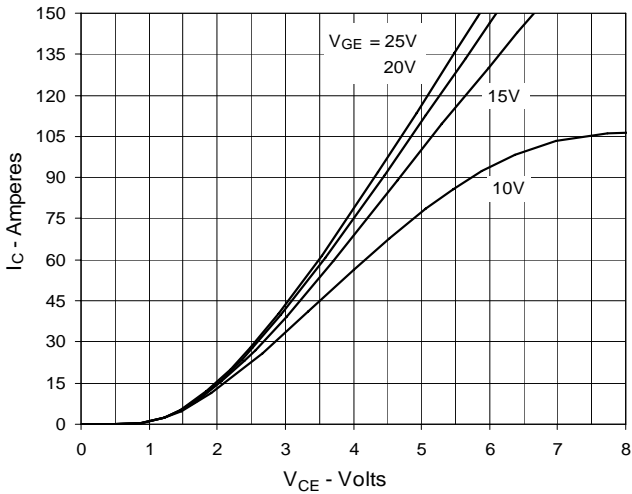

**Fig. 2. Extended Output Characteristics @ 25°C**

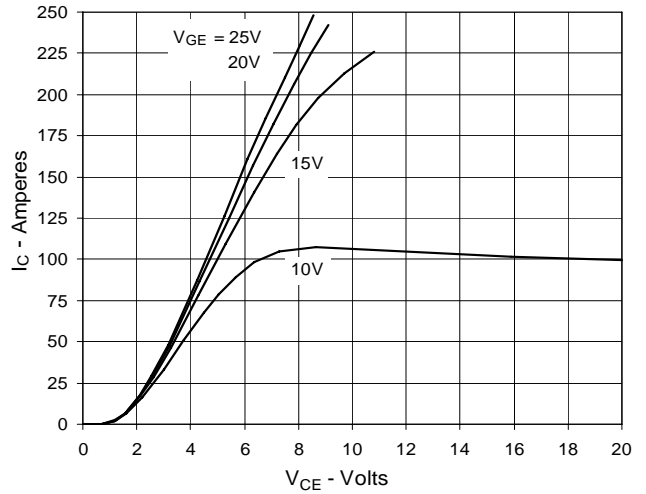

**Fig. 3. Output Characteristics @ 125°C**

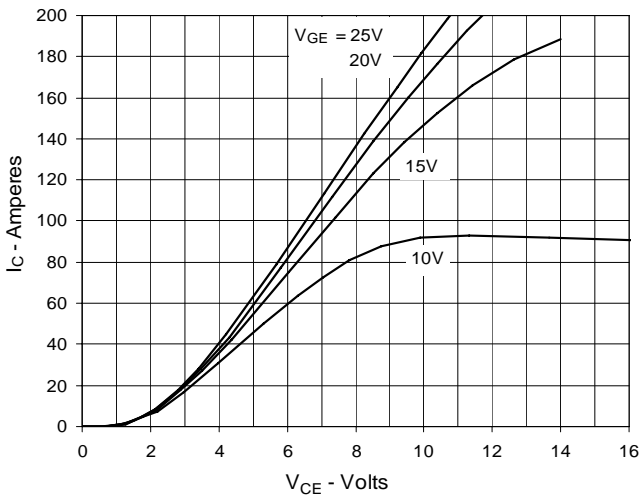

**Fig. 4. Dependence of VCE(sat) on Junction Temperature**

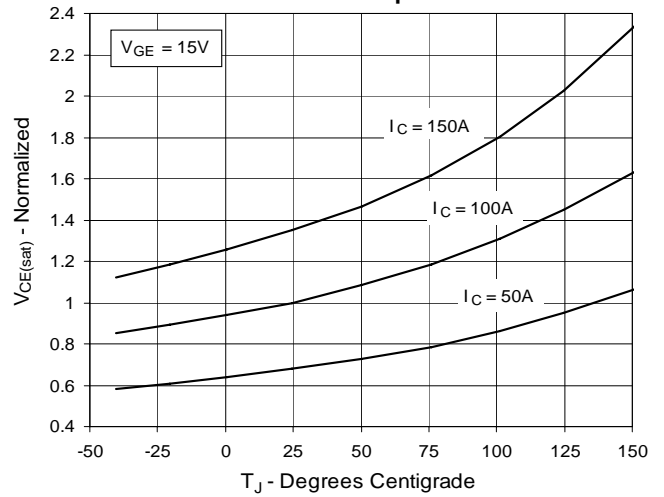

**Fig. 5. Collector-to-Emitter Voltage vs. Gate-to-Emitter Voltage**

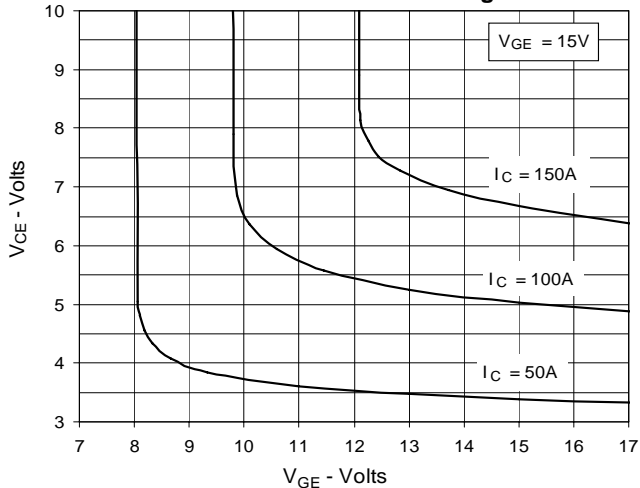

**Fig. 6. Input Admittance**

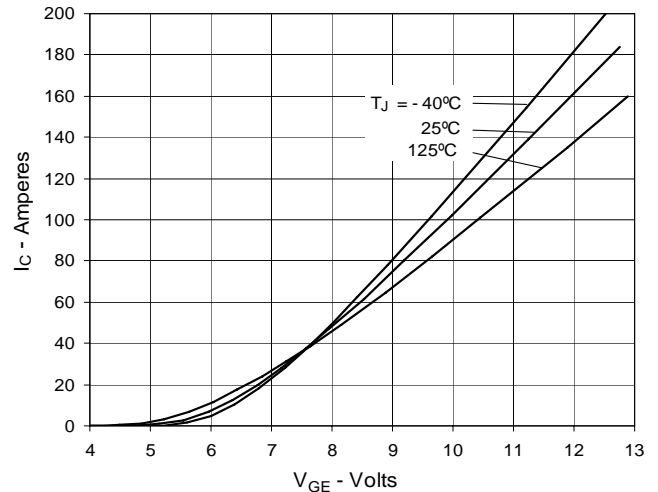

Fig. 7. Transconductance

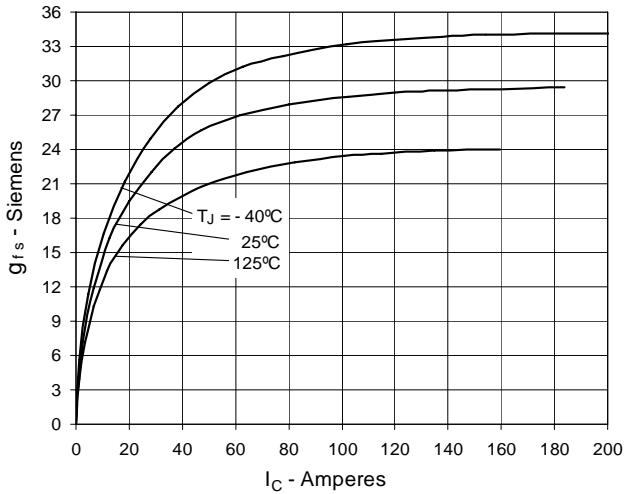

Fig. 8. Resistive Turn-on Rise Time vs. Junction Temperature

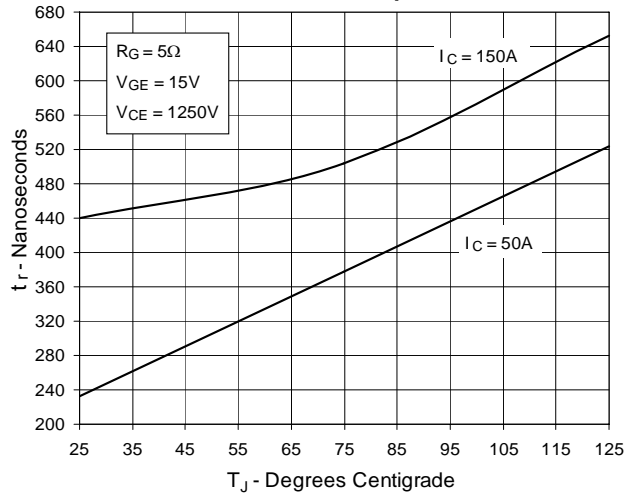

Fig. 9. Resistive Turn-on Rise Time vs. Collector Current

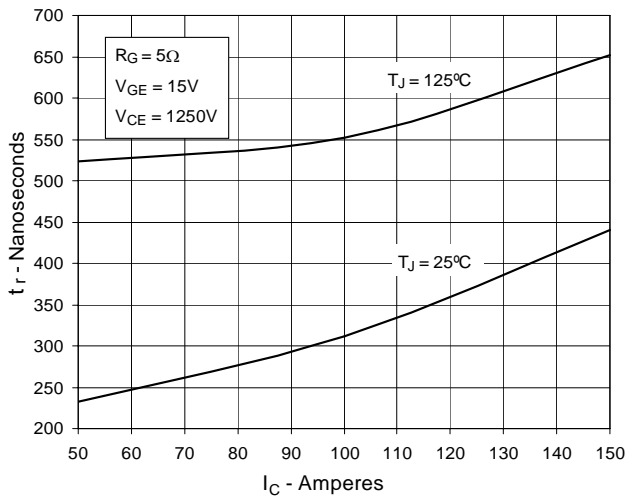

Fig. 10. Resistive Turn-on Switching Times vs. Gate Resistance

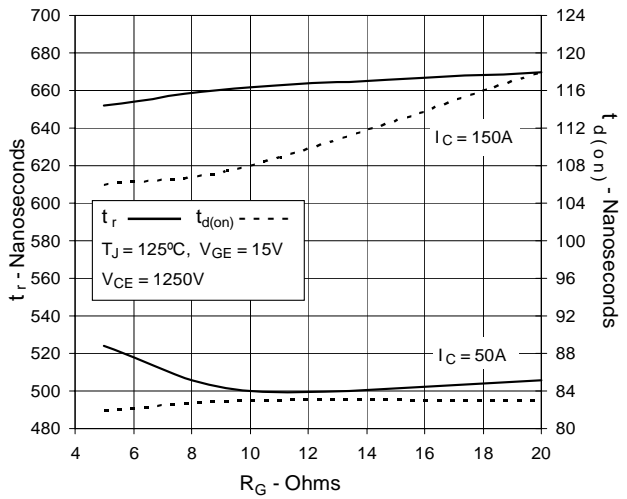

Fig. 11. Resistive Turn-off Switching Times vs. Junction Temperature

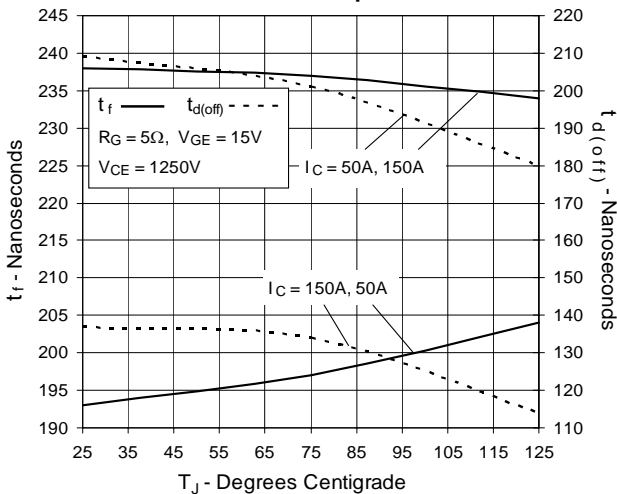
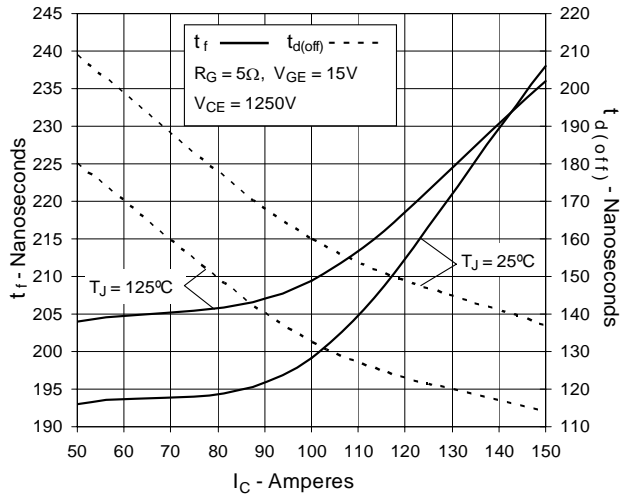
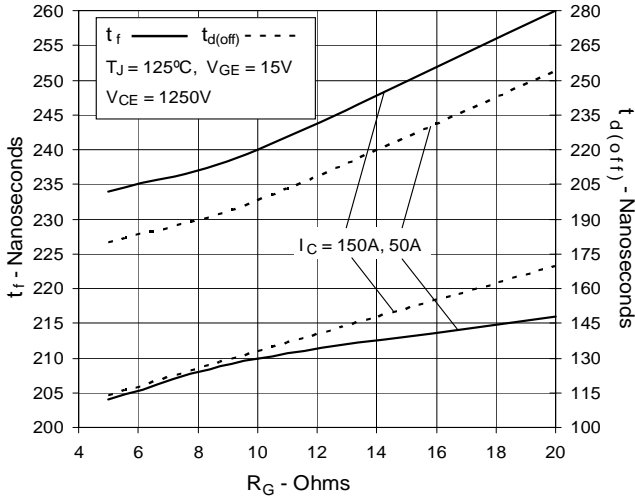

Fig. 12. Resistive Turn-off Switching Times vs. Collector Current



**Fig. 13. Resistive Turn-off Switching Times vs. Gate Resistance**



**Fig. 14. Gate Charge**

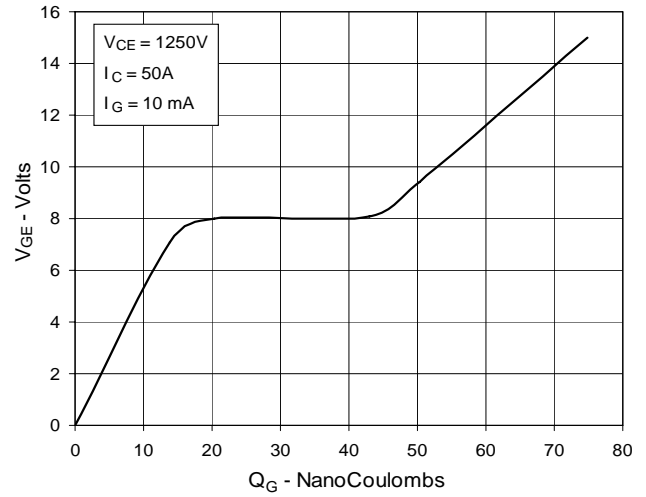

**Fig. 15. Reverse-Bias Safe Operating Area**

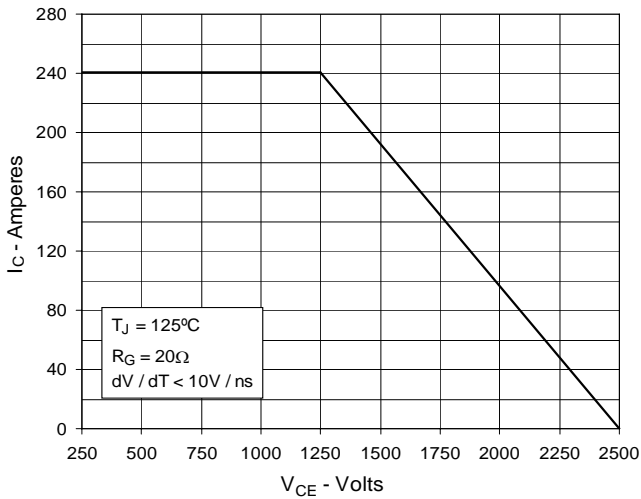

**Fig. 16. Capacitance**

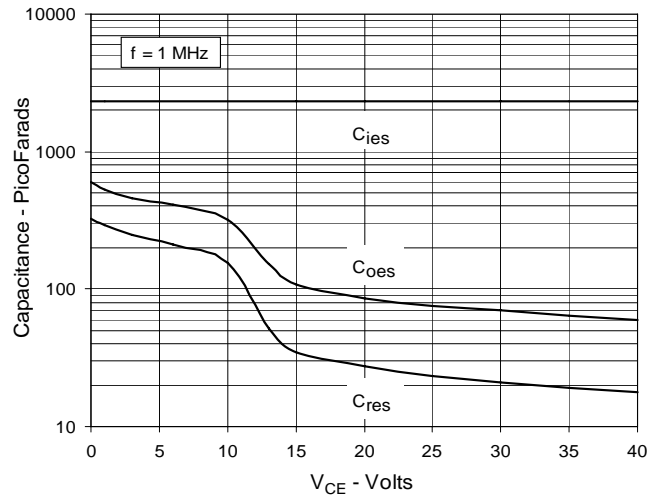

**Fig. 17. Maximum Transient Thermal Impedance**

