

# HiPerFAST™ IGBT with Diode

**IXGH 30N60BD1**  
**IXGT 30N60BD1**

$V_{CES} = 600 \text{ V}$   
 $I_{C25} = 60 \text{ A}$   
 $V_{CE(sat)} = 1.8 \text{ V}$   
 $t_{fi(typ)} = 100 \text{ ns}$

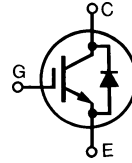

Symbol	Test Conditions	Maximum Ratings	
$V_{CES}$	$T_J = 25^\circ\text{C}$ to $150^\circ\text{C}$	600	V
$V_{CGR}$	$T_J = 25^\circ\text{C}$ to $150^\circ\text{C}$ ; $R_{GE} = 1 \text{ M}\Omega$	600	V
$V_{GES}$	Continuous	$\pm 20$	V
$V_{GEM}$	Transient	$\pm 30$	V
$I_{C25}$	$T_C = 25^\circ\text{C}$	60	A
$I_{C90}$	$T_C = 90^\circ\text{C}$	30	A
$I_{CM}$	$T_C = 25^\circ\text{C}$ , 1 ms	120	A
<b>SSOA</b> <b>(RBSOA)</b>	$V_{GE} = 15 \text{ V}$ , $T_{VJ} = 125^\circ\text{C}$ , $R_G = 10 \Omega$ Clamped inductive load, $L = 100 \mu\text{H}$	$I_{CM} = 60$ @ $0.8 V_{CES}$	A
$P_C$	$T_C = 25^\circ\text{C}$	200	W
$T_J$		-55 ... +150	$^\circ\text{C}$
$T_{JM}$		150	$^\circ\text{C}$
$T_{stg}$		-55 ... +150	$^\circ\text{C}$
Maximum Lead and Tab temperature for soldering 1.6 mm (0.062 in.) from case for 10 s		300	$^\circ\text{C}$
$M_d$	Mounting torque, TO-247 AD	1.13/10	Nm/lb.in.
<b>Weight</b>	TO-247 AD	6	g
	TO-268	4	g

**TO-268**  
**(IXGT)**

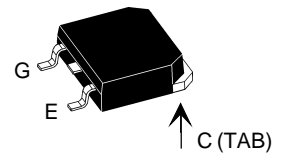

**TO-247 AD**  
**(IXGH)**

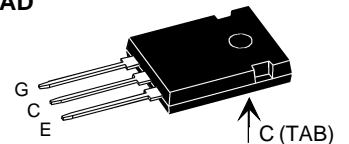

G = Gate, C = Collector,  
E = Emitter, TAB = Collector

### Features

- International standard package
- Moderate frequency IGBT and antiparallel FRED in one package
- High current handling capability
- Newest generation HDMOS™ process
- MOS Gate turn-on - drive simplicity

### Applications

- AC motor speed control
- DC servo and robot drives
- DC choppers
- Uninterruptible power supplies (UPS)
- Switch-mode and resonant-mode power supplies

### Advantages

- Space savings (two devices in one package)
- High power density
- Optimized  $V_{CE(sat)}$  and switching speeds for medium frequency application

Symbol	Test Conditions	Characteristic Values ( $T_J = 25^\circ\text{C}$ , unless otherwise specified)		
		min.	typ.	max.
$BV_{CES}$	$I_C = 250 \mu\text{A}$ , $V_{GE} = 0 \text{ V}$	600		V
$V_{GE(th)}$	$I_C = 250 \mu\text{A}$ , $V_{CE} = V_{GE}$	2.5		5.0 V
$I_{CES}$	$V_{CE} = 0.8 \cdot V_{CES}$ $V_{GE} = 0 \text{ V}$	$T_J = 25^\circ\text{C}$		200 $\mu\text{A}$
		$T_J = 150^\circ\text{C}$		3 mA
$I_{GES}$	$V_{CE} = 0 \text{ V}$ , $V_{GE} = \pm 20 \text{ V}$			$\pm 100 \text{ nA}$
$V_{CE(sat)}$	$I_C = I_{C90}$ , $V_{GE} = 15 \text{ V}$			1.8 V

Symbol	Test Conditions	Characteristic Values ( $T_J = 25^\circ\text{C}$ , unless otherwise specified)			
		min.	typ.	max.	
$g_{fs}$	$I_C = I_{C90}$ ; $V_{CE} = 10\text{ V}$ , Pulse test, $t \leq 300\ \mu\text{s}$ , duty cycle $\leq 2\%$		25	S	
$C_{ies}$	$V_{CE} = 25\text{ V}$ , $V_{GE} = 0\text{ V}$ , $f = 1\text{ MHz}$		2700	pF	
$C_{oes}$			240	pF	
$C_{res}$			50	pF	
$Q_g$	$I_C = I_{C90}$ ; $V_{GE} = 15\text{ V}$ , $V_{CE} = 0.5 V_{CES}$		110	nC	
$Q_{ge}$			22	nC	
$Q_{gc}$			40	nC	
$t_{d(on)}$	<b>Inductive load, <math>T_J = 25^\circ\text{C}</math></b> $I_C = I_{C90}$ , $V_{GE} = 15\text{ V}$ , $L = 100\ \mu\text{H}$ , $V_{CE} = 0.8 V_{CES}$ , $R_G = R_{off} = 4.7\ \Omega$ Remarks: Switching times may increase for $V_{CE}$ (Clamp) $> 0.8 \cdot V_{CES}$ , higher $T_J$ or increased $R_G$		25	ns	
$t_{ri}$			30	ns	
$t_{d(off)}$			130	220	ns
$t_{fi}$			100	190	ns
$E_{off}$			1.0	2.0	mJ
$t_{d(on)}$	<b>Inductive load, <math>T_J = 150^\circ\text{C}</math></b> $I_C = I_{C90}$ , $V_{GE} = 15\text{ V}$ , $L = 100\ \mu\text{H}$ , $V_{CE} = 0.8 V_{CES}$ , $R_G = R_{off} = 4.7\ \Omega$ Remarks: Switching times may increase for $V_{CE}$ (Clamp) $> 0.8 \cdot V_{CES}$ , higher $T_J$ or increased $R_G$		25	ns	
$t_{ri}$			35	ns	
$E_{on}$			1.0	mJ	
$t_{d(off)}$			200	ns	
$t_{fi}$			230	ns	
$E_{off}$		2.5	mJ		
$R_{thJC}$				0.62 K/W	
$R_{thCK}$	(TO-247 AD)		0.25	K/W	

### TO-247 AD (IXGH) Outline

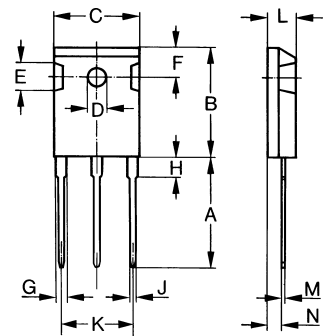

Dim.	Millimeter		Inches	
	Min.	Max.	Min.	Max.
A	19.81	20.32	0.780	0.800
B	20.80	21.46	0.819	0.845
C	15.75	16.26	0.610	0.640
D	3.55	3.65	0.140	0.144
E	4.32	5.49	0.170	0.216
F	5.4	6.2	0.212	0.244
G	1.65	2.13	0.065	0.084
H	-	4.5	-	0.177
J	1.0	1.4	0.040	0.055
K	10.8	11.0	0.426	0.433
L	4.7	5.3	0.185	0.209
M	0.4	0.8	0.016	0.031
N	1.5	2.49	0.087	0.102

### Reverse Diode (FRED)

Symbol	Test Conditions	Characteristic Values ( $T_J = 25^\circ\text{C}$ , unless otherwise specified)		
		min.	typ.	max.
$V_F$	$I_F = I_{C90}$ , $V_{GE} = 0\text{ V}$ , Pulse test $t \leq 300\ \mu\text{s}$ , duty cycle $d \leq 2\%$			1.6 V 2.5 V
$I_{RM}$	$I_F = I_{C90}$ , $V_{GE} = 0\text{ V}$ , $-di_F/dt = 100\text{ A}/\mu\text{s}$ $V_R = 100\text{ V}$ $I_F = 1\text{ A}$ ; $-di/dt = 100\text{ A}/\mu\text{s}$ ; $V_R = 30\text{ V}$		6	A
$t_{rr}$			100	ns
			25	ns
$R_{thJC}$				0.9 K/W

### TO-268AA (D<sup>3</sup> PAK)

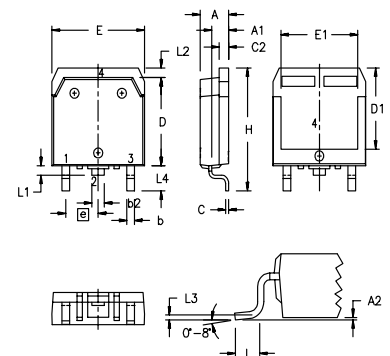

Dim.	Millimeter		Inches	
	Min.	Max.	Min.	Max.
A	4.9	5.1	.193	.201
A <sub>1</sub>	2.7	2.9	.106	.114
A <sub>2</sub>	.02	.25	.001	.010
b	1.15	1.45	.045	.057
b <sub>2</sub>	1.9	2.1	.75	.83
C	.4	.65	.016	.026
D	13.80	14.00	.543	.551
E	15.85	16.05	.624	.632
E <sub>1</sub>	13.3	13.6	.524	.535
e	5.45 BSC		.215 BSC	
H	18.70	19.10	.736	.752
L	2.40	2.70	.094	.106
L <sub>1</sub>	1.20	1.40	.047	.055
L <sub>2</sub>	1.00	1.15	.039	.045
L <sub>3</sub>	0.25 BSC		.010 BSC	
L <sub>4</sub>	3.80	4.10	.150	.161

### Min. Recommended Footprint

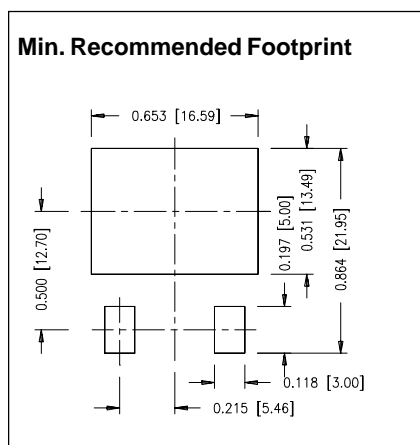

Fig. 1. Saturation Voltage Characteristics

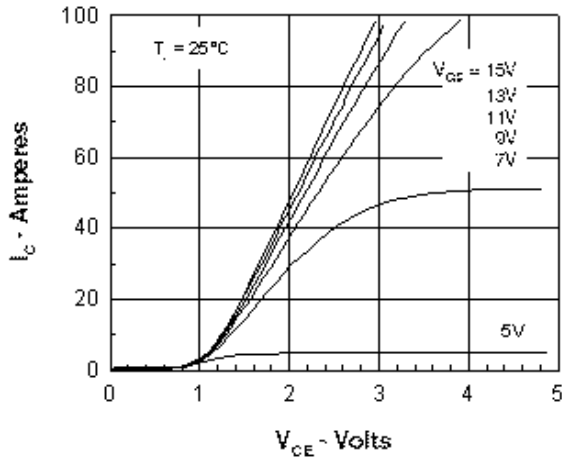

Fig. 3. Saturation Voltage Characteristics

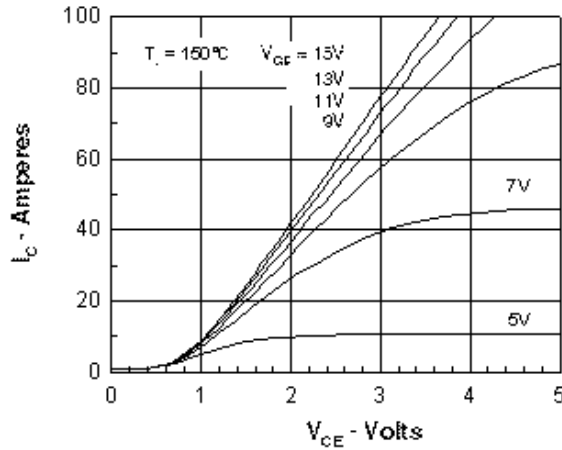

Fig. 5. Admittance Curves

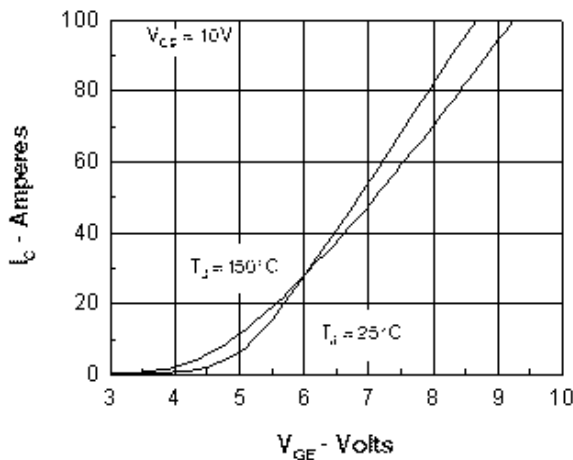

Fig. 2. Extended Output Characteristics

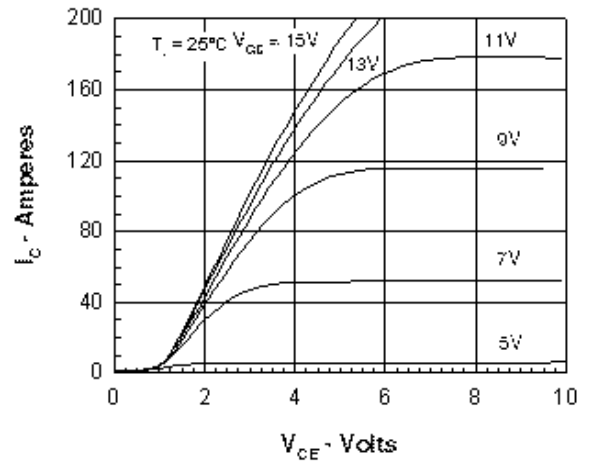
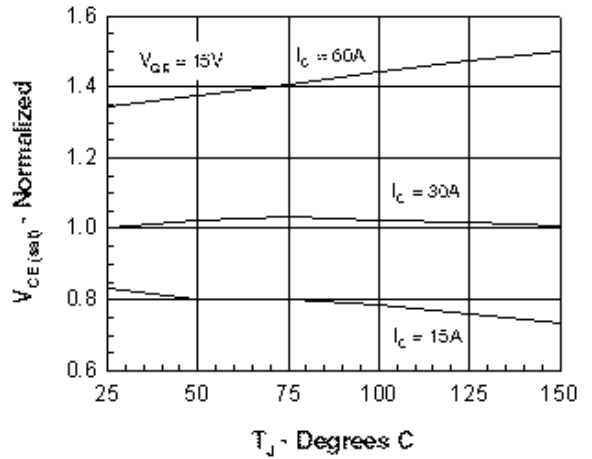
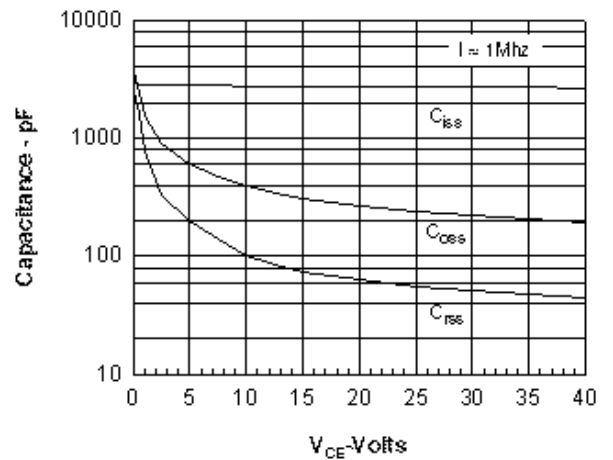

 Fig. 4. Temperature Dependence of  $V_{CE(sat)}$ 

 Fig. 6. Temperature Dependence of  $BV_{DSS}$  &  $V_{GE(th)}$ 

Fig. 7. Dependence of  $E_{OFF}$  and  $E_{ON}$  on  $I_C$ .

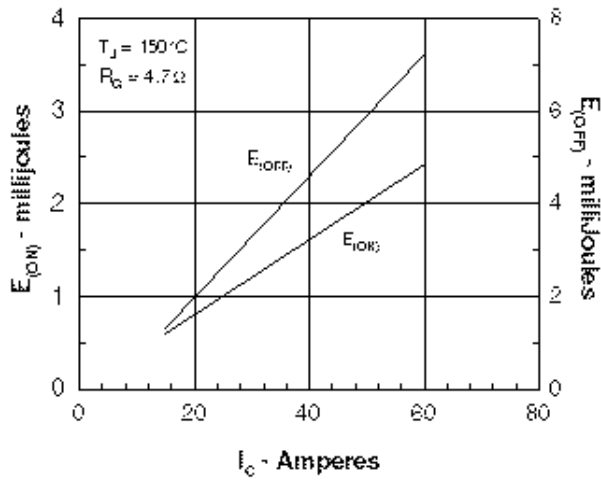

Fig. 8. Dependence of  $E_{OFF}$  on  $R_G$ .

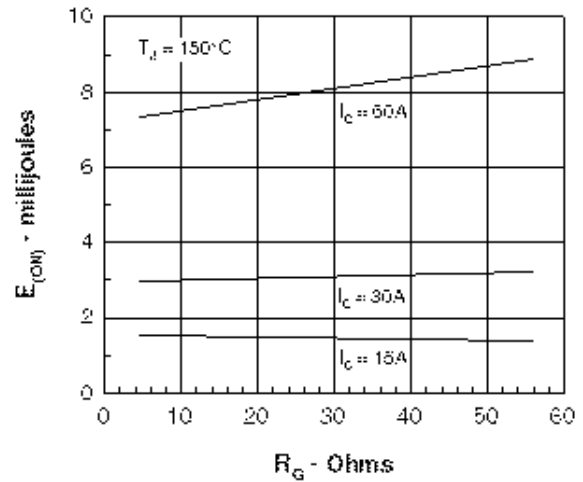

Fig. 9. Gate Charge

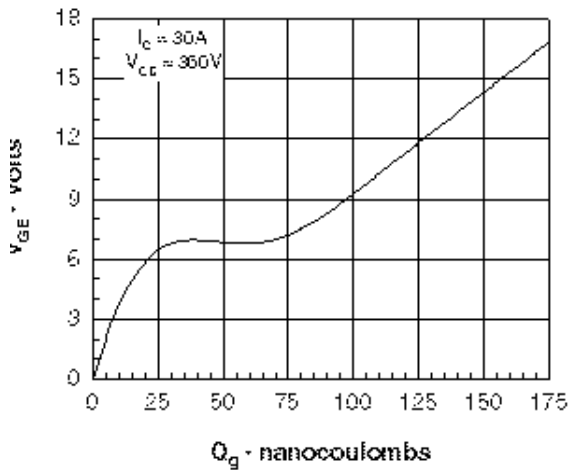

Fig. 10. Turn-off Safe Operating Area

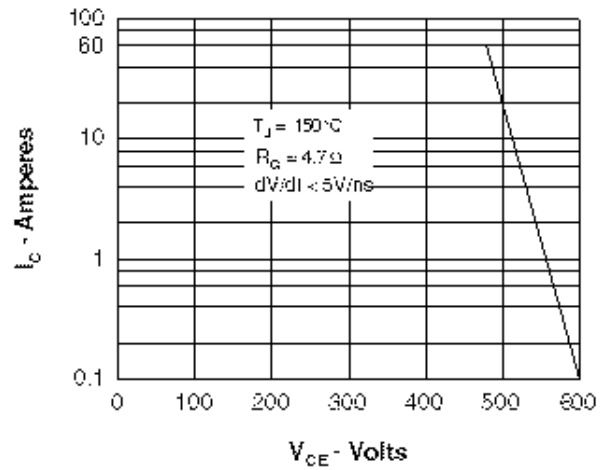
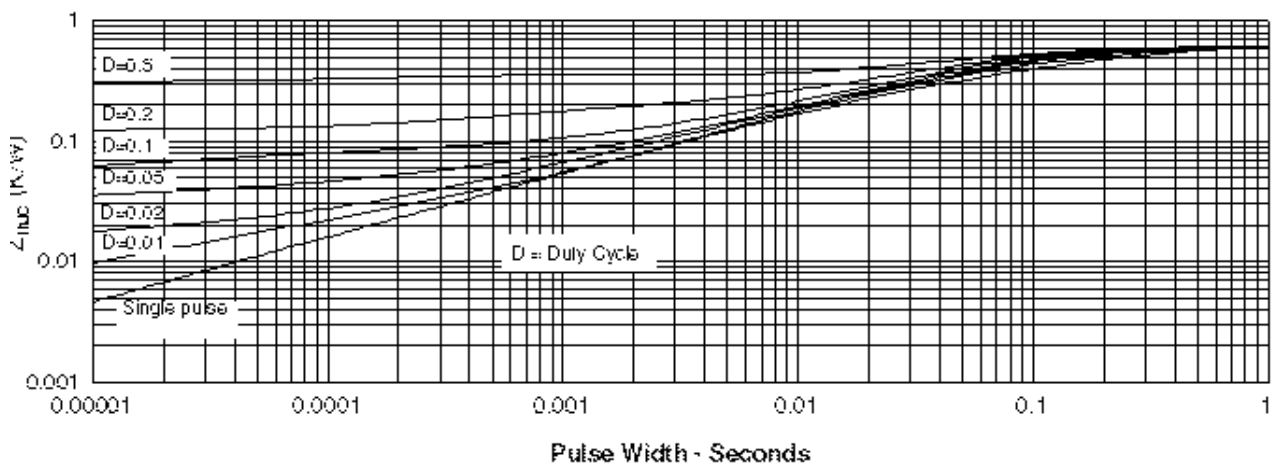

Fig. 11. IGBT Transient Thermal Resistance



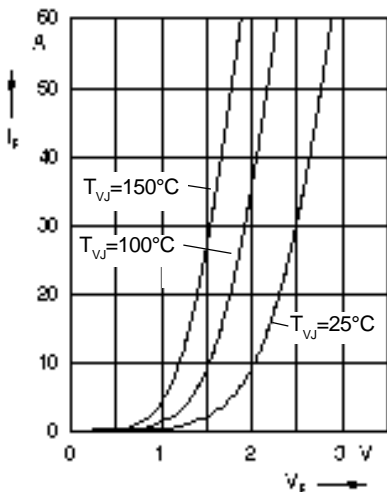

Fig. 12 Forward current  $I_F$  versus  $V_F$

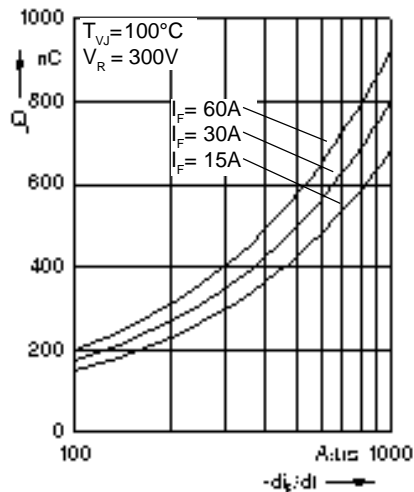

Fig. 13 Reverse recovery charge  $Q_r$  versus  $-di_F/dt$

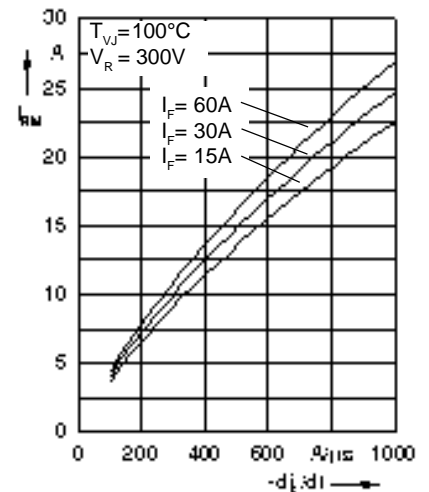

Fig. 14 Peak reverse current  $I_{RM}$  versus  $-di_F/dt$

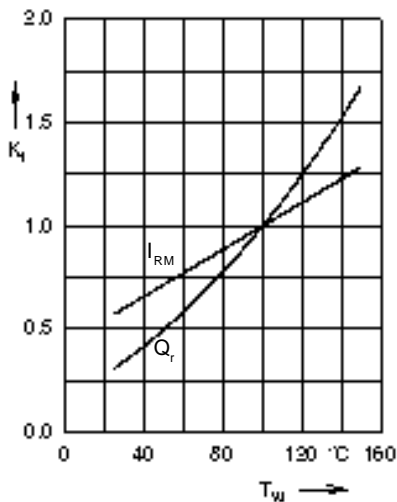

Fig. 15 Dynamic parameters  $Q_r$ ,  $I_{RM}$  versus  $T_{VJ}$

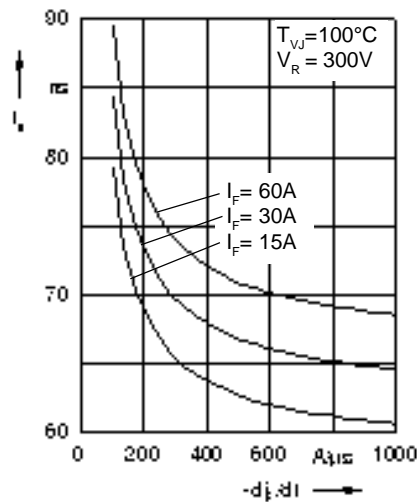

Fig. 16 Recovery time  $t_{tr}$  versus  $-di_F/dt$

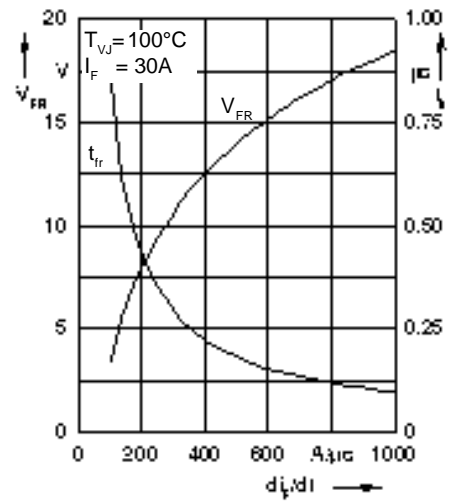

Fig. 17 Peak forward voltage  $V_{FR}$  and  $t_{tr}$  versus  $di_F/dt$

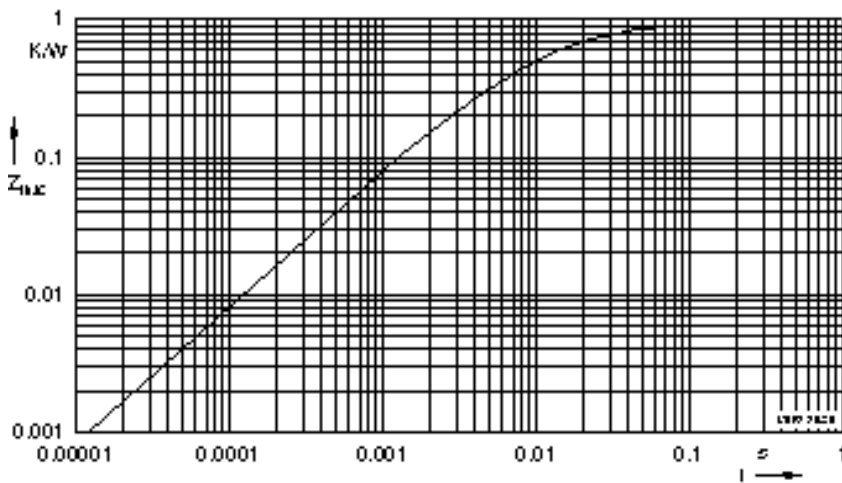

Fig. 18 Transient thermal resistance junction to case

Constants for  $Z_{thJC}$  calculation:

i	$R_{thi}$ (K/W)	$t_i$ (s)
1	0.502	0.0052
2	0.193	0.0003
3	0.205	0.0162