

# HiPerFAST™ IGBT with Diode

**IXGH 32N60CD1**  
**IXGT 32N60CD1**

$V_{CES} = 600 \text{ V}$   
 $I_{C25} = 60 \text{ A}$   
 $V_{CE(SAT)typ} = 2.1 \text{ V}$   
 $t_{fi(typ)} = 55 \text{ ns}$

## Light Speed Series

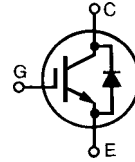

Symbol	Test Conditions	Maximum Ratings	
$V_{CES}$	$T_J = 25^\circ\text{C to } 150^\circ\text{C}$	600	V
$V_{CGR}$	$T_J = 25^\circ\text{C to } 150^\circ\text{C}; R_{GE} = 1 \text{ M}\Omega$	600	V
$V_{GES}$	Continuous	$\pm 20$	V
$V_{GEM}$	Transient	$\pm 30$	V
$I_{C25}$	$T_C = 25^\circ\text{C}$	60	A
$I_{C90}$	$T_C = 90^\circ\text{C}$	32	A
$I_{CM}$	$T_C = 25^\circ\text{C}, 1 \text{ ms}$	120	A
<b>SSOA</b> <b>(RBSOA)</b>	$V_{GE} = 15 \text{ V}, T_{VJ} = 125^\circ\text{C}, R_G = 10 \Omega$ Clamped inductive load @ $0.8 V_{CES}$	$I_{CM} = 64$	A
$P_C$	$T_C = 25^\circ\text{C}$	200	W
$T_J$		-55 ... +150	$^\circ\text{C}$
$T_{JM}$		150	$^\circ\text{C}$
$T_{stg}$		-55 ... +150	$^\circ\text{C}$
Maximum Lead and Tab temperature for soldering 1.6 mm (0.062 in.) from case for 10 s		300	$^\circ\text{C}$
$M_d$	Mounting torque, TO-247 AD	1.13/10	Nm/lb.in.
<b>Weight</b>	TO-247 AD	6	g
	TO-268	5	g

TO-247 AD (IXGH)

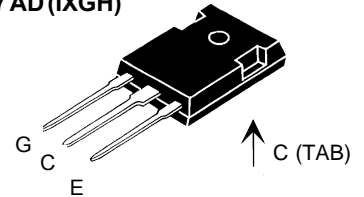

TO-268 (D3) (IXGT)

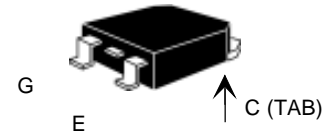

G = Gate      C = Collector  
E = Emitter

### Features

- International standard TO-247AD package
- High current handling capability
- Latest generation HDMOS™ process
- MOS Gate turn-on - drive simplicity

### Applications

- Uninterruptible power supplies (UPS)
- Switched-mode and resonant-mode power supplies
- AC motor speed control
- DC servo and robot drives
- DC choppers

### Advantages

- High power density
- Very fast switching speeds for high frequency applications
- High power surface mountable package

Symbol	Test Conditions	Characteristic Values ( $T_J = 25^\circ\text{C}$ , unless otherwise specified)		
		min.	typ.	max.
$BV_{CES}$	$I_C = 250 \mu\text{A}, V_{GE} = 0 \text{ V}$	600		V
$V_{GE(th)}$	$I_C = 250 \mu\text{A}, V_{CE} = V_{GE}$	2.5		5.0 V
$I_{CES}$	$V_{CE} = 0.8 \cdot V_{CES}$ $V_{GE} = 0 \text{ V}$	$T_J = 25^\circ\text{C}$		200 $\mu\text{A}$
		$T_J = 125^\circ\text{C}$		3 mA
$I_{GES}$	$V_{CE} = 0 \text{ V}, V_{GE} = \pm 20 \text{ V}$			$\pm 100 \text{ nA}$
$V_{CE(sat)}$	$I_C = I_{C90}, V_{GE} = 15 \text{ V}$	2.1	2.5	V

Symbol	Test Conditions	Characteristic Values		
		(T <sub>J</sub> = 25°C, unless otherwise specified)		
		min.	typ.	max.
<b>g<sub>fs</sub></b>	I <sub>C</sub> = I <sub>C90</sub> ; V <sub>CE</sub> = 10 V, Pulse test, t ≤ 300 μs, duty cycle ≤ 2 %		25	S
<b>C<sub>ies</sub></b>	V <sub>CE</sub> = 25 V, V <sub>GE</sub> = 0 V, f = 1 MHz		2700	pF
<b>C<sub>oes</sub></b>			240	pF
<b>C<sub>res</sub></b>			50	pF
<b>Q<sub>g</sub></b>	I <sub>C</sub> = I <sub>C90</sub> ; V <sub>GE</sub> = 15 V, V <sub>CE</sub> = 0.5 V <sub>CES</sub>		110	nC
<b>Q<sub>ge</sub></b>			22	nC
<b>Q<sub>gc</sub></b>			40	nC
<b>t<sub>d(on)</sub></b>	<b>Inductive load, T<sub>J</sub> = 25°C</b> I <sub>C</sub> = I <sub>C90</sub> ; V <sub>GE</sub> = 15 V V <sub>CE</sub> = 0.8 V <sub>CES</sub> ; R <sub>G</sub> = R <sub>off</sub> = 4.7 Ω Remarks: Switching times may increase for V <sub>CE</sub> (Clamp) > 0.8 • V <sub>CES</sub> , higher T <sub>J</sub> or increased R <sub>G</sub>		25	ns
<b>t<sub>ri</sub></b>			20	ns
<b>t<sub>d(off)</sub></b>			85	ns
<b>t<sub>fi</sub></b>			55	ns
<b>E<sub>off</sub></b>			0.32	mJ
<b>t<sub>d(on)</sub></b>	<b>Inductive load, T<sub>J</sub> = 125°C</b> I <sub>C</sub> = I <sub>C90</sub> ; V <sub>GE</sub> = 15 V V <sub>CE</sub> = 0.8 V <sub>CES</sub> ; R <sub>G</sub> = R <sub>off</sub> = 4.7 Ω Remarks: Switching times may increase for V <sub>CE</sub> (Clamp) > 0.8 • V <sub>CES</sub> , higher T <sub>J</sub> or increased R <sub>G</sub>		25	ns
<b>t<sub>ri</sub></b>			25	ns
<b>E<sub>on</sub></b>			1	mJ
<b>t<sub>d(off)</sub></b>			110	170 ns
<b>t<sub>fi</sub></b>			100	160 ns
<b>E<sub>off</sub></b>		0.85	1.25 mJ	
<b>R<sub>thJC</sub></b>				0.62 K/W
<b>R<sub>thCK</sub></b>		0.25		K/W

Symbol	Test Conditions	Characteristic Values		
		(T <sub>J</sub> = 25°C, unless otherwise specified)		
		min.	typ.	max.
<b>V<sub>F</sub></b>	I <sub>F</sub> = I <sub>C90</sub> ; V <sub>GE</sub> = 0 V, Pulse test t ≤ 300 μs, duty cycle d ≤ 2 %	T <sub>J</sub> = 150°C		1.6 V
		T <sub>J</sub> = 25°C		2.5 V
<b>I<sub>RM</sub></b>	I <sub>F</sub> = I <sub>C90</sub> ; V <sub>GE</sub> = 0 V, -di <sub>F</sub> /dt = 100 A/μs V <sub>R</sub> = 100 V I <sub>F</sub> = 1 A; -di <sub>F</sub> /dt = 100 A/μs; V <sub>R</sub> = 30 V	T <sub>J</sub> = 100°C	6	A
<b>t<sub>rr</sub></b>		T <sub>J</sub> = 25°C	100	ns
			25	ns
<b>R<sub>thJC</sub></b>				0.9 K/W

### TO-247 AD Outline

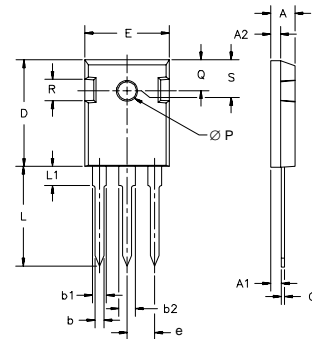

Dim.	Millimeter		Inches	
	Min.	Max.	Min.	Max.
A	4.7	5.3	.185	.209
A <sub>1</sub>	2.2	2.54	.087	.102
A <sub>2</sub>	2.2	2.6	.059	.098
b	1.0	1.4	.040	.055
b <sub>1</sub>	1.65	2.13	.065	.084
b <sub>2</sub>	2.87	3.12	.113	.123
C	.4	.8	.016	.031
D	20.80	21.46	.819	.845
E	15.75	16.26	.610	.640
e	5.20	5.72	0.205	0.225
L	19.81	20.32	.780	.800
L <sub>1</sub>		4.50		.177
ØP	3.55	3.65	.140	.144
Q	5.89	6.40	0.232	0.252
R	4.32	5.49	.170	.216
S	6.15	BSC	.242	BSC

### TO-268 Outline

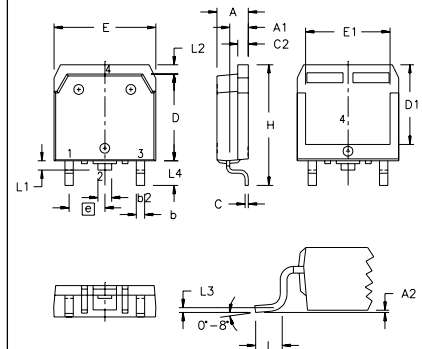

Terminals: 1 - Gate 2 - Collector  
3 - Emitter

SYM	INCHES		MILLIMETERS	
	MIN	MAX	MIN	MAX
A	.193	.201	4.90	5.10
A <sub>1</sub>	.106	.114	2.70	2.90
A <sub>2</sub>	.001	.010	0.02	0.25
b	.045	.057	1.15	1.45
b <sub>2</sub>	.075	.083	1.90	2.10
C	.016	.026	0.40	0.65
C <sub>2</sub>	.057	.063	1.45	1.60
D	5.43	5.51	13.80	14.00
D <sub>1</sub>	4.88	5.00	12.40	12.70
E	.624	.632	15.85	16.05
E <sub>1</sub>	.524	.535	13.30	13.60
e	.215 BSC		5.45 BSC	
H	.736	.752	18.70	19.10
L	.094	.106	2.40	2.70
L <sub>1</sub>	.047	.055	1.20	1.40
L <sub>2</sub>	.039	.045	1.00	1.15
L <sub>3</sub>	.010 BSC		0.25 BSC	
L <sub>4</sub>	.150	.161	3.80	4.10

IXYS reserves the right to change limits, test conditions, and dimensions.

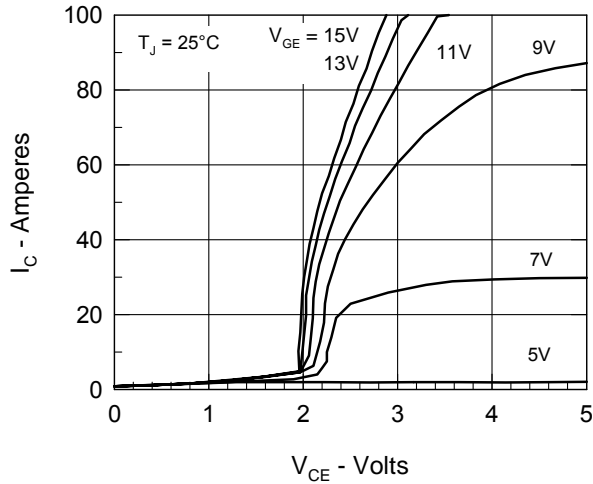

Fig. 1. Output Characteristics

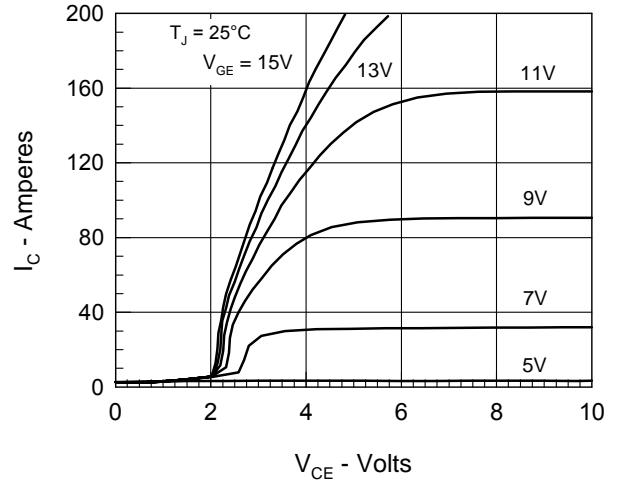

Fig. 2. Extended Output Characteristics

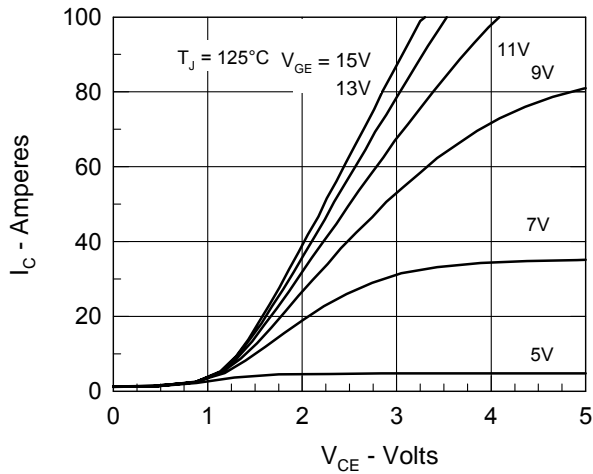

Fig. 3. High Temperature Output Characteristics

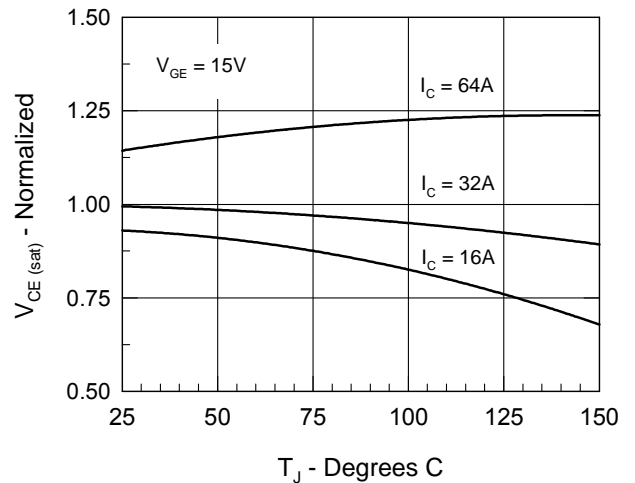

Fig. 4. Temperature Dependence of  $V_{CE(sat)}$

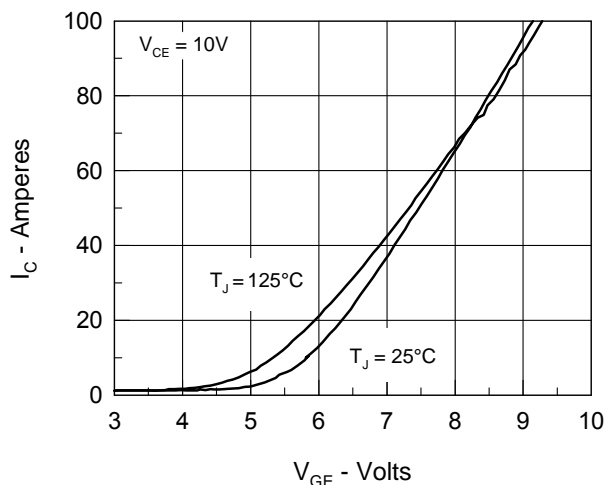

Fig. 5. Admittance Curves

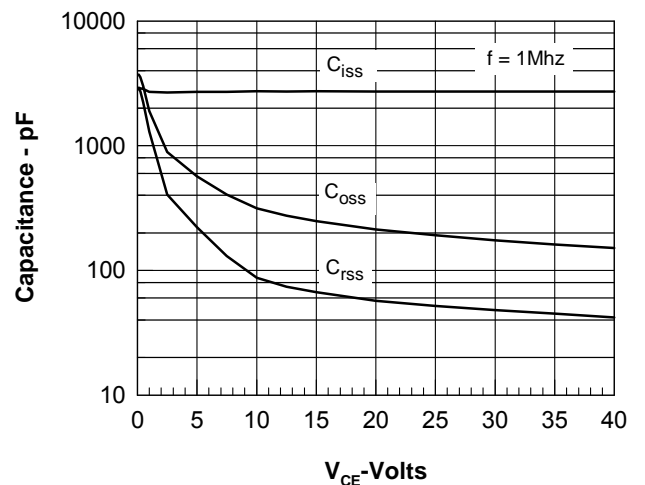

Fig. 6. Capacitance Curves

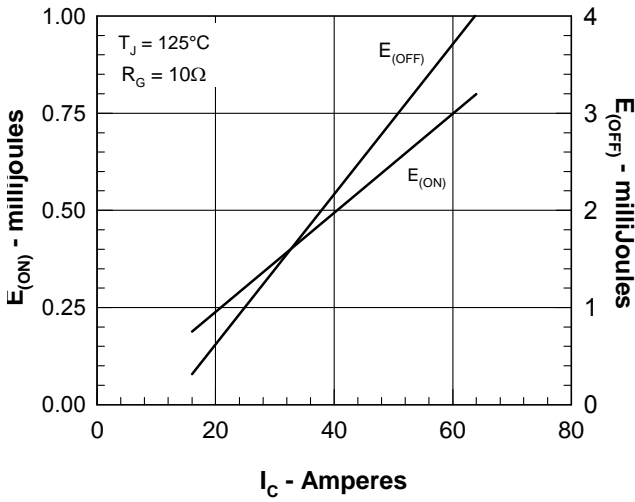

Fig. 7. Dependence of  $E_{ON}$  and  $E_{OFF}$  on  $I_C$ .

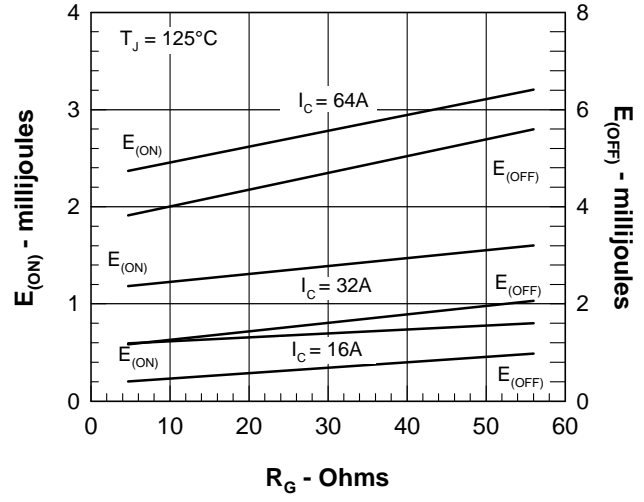

Fig. 8. Dependence of  $E_{ON}$  and  $E_{OFF}$  on  $R_G$ .

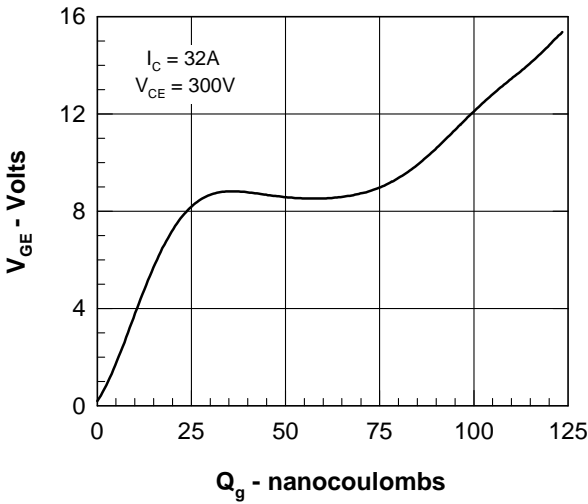

Fig. 9. Gate Charge

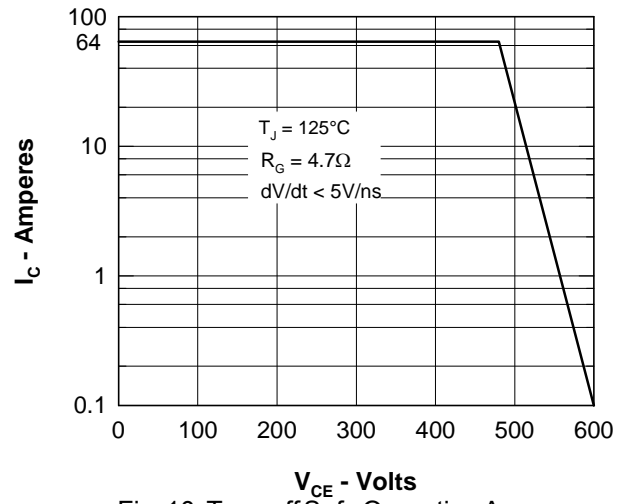

Fig. 10. Turn-off Safe Operating Area

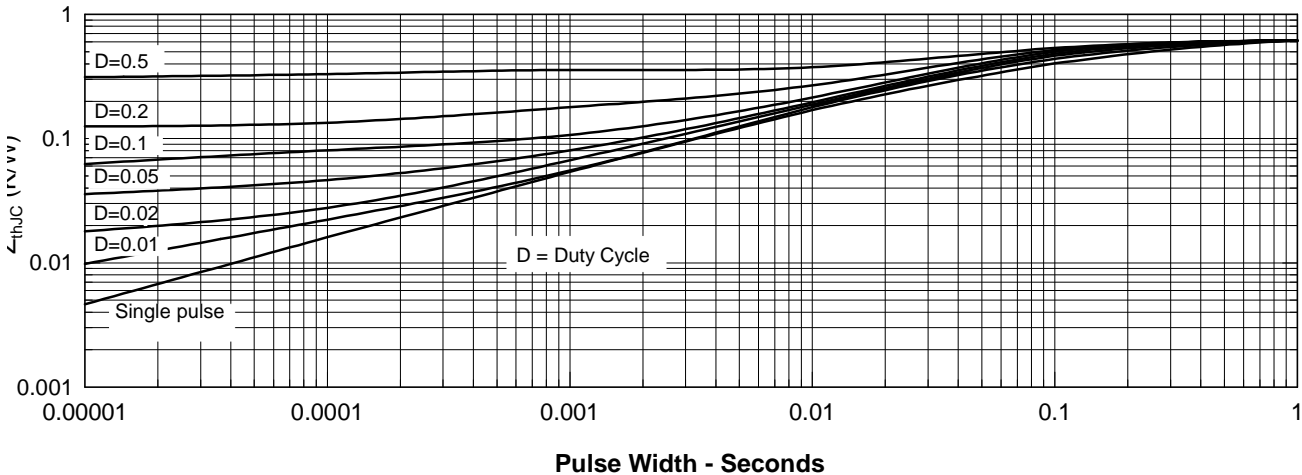

Fig. 11. Transient Thermal Resistance

IXYS reserves the right to change limits, test conditions, and dimensions.

IXYS MOSFETs and IGBTs are covered by one or more of the following U.S. patents:

4,835,592	4,881,106	5,017,508	5,049,961	5,187,117	5,486,715	6,306,728B1
4,850,072	4,931,844	5,034,796	5,063,307	5,237,481	5,381,025	

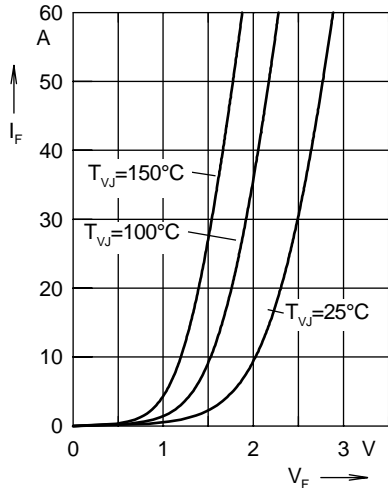

Fig. 12 Forward current  $I_F$  versus  $V_F$

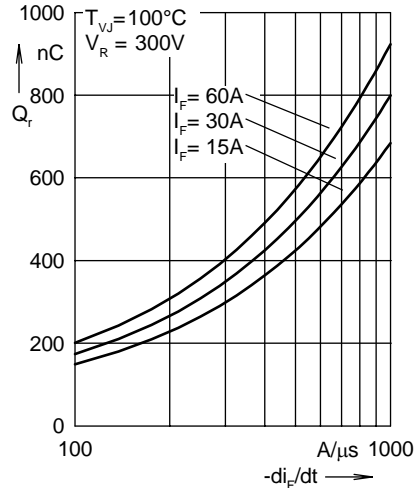

Fig. 13 Reverse recovery charge  $Q_r$  versus  $-di_F/dt$

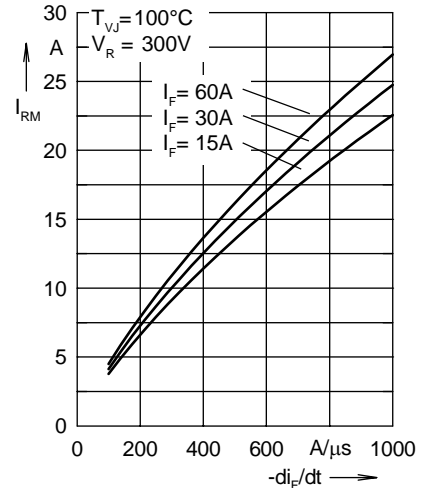

Fig. 14 Peak reverse current  $I_{RM}$  versus  $-di_F/dt$

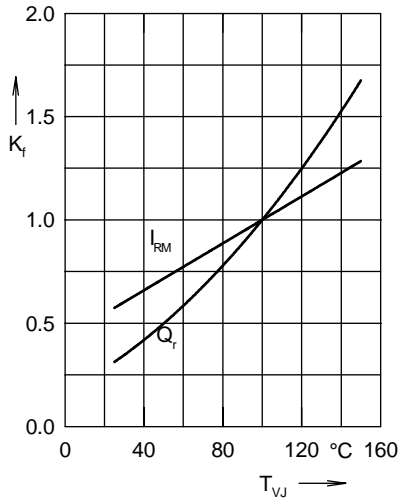

Fig. 15 Dynamic parameters  $Q_r$ ,  $I_{RM}$  versus  $T_{VJ}$

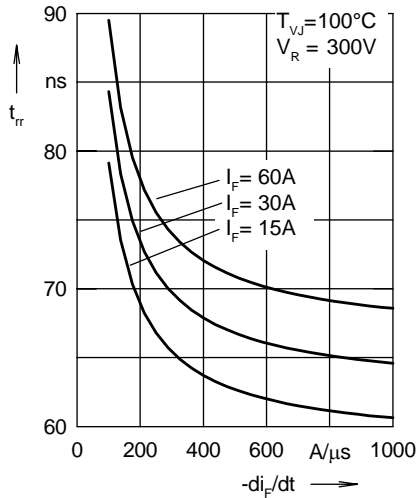

Fig. 16 Recovery time  $t_{rr}$  versus  $-di_F/dt$

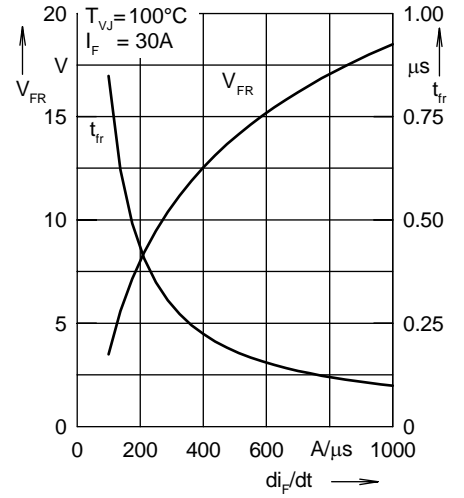

Fig. 17 Peak forward voltage  $V_{FR}$  and  $t_{rr}$  versus  $di_F/dt$

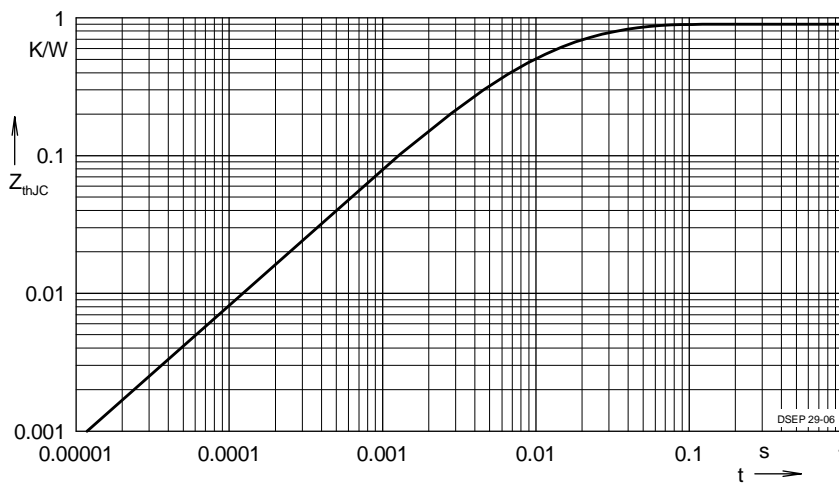

Fig. 18 Transient thermal resistance junction to case

Constants for  $Z_{thJC}$  calculation:

i	$R_{thi}$ (K/W)	$t_i$ (s)
1	0.502	0.0052
2	0.193	0.0003
3	0.205	0.0162