

# HiPerFAST™ IGBT with Fast Diode

IXGH 32N90B2D1  
IXGT 32N90B2D1

## B2-Class High Speed IGBTs with Ultrafast Diode

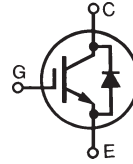

$$\begin{aligned} V_{CES} &= 900 \text{ V} \\ I_{C25} &= 64 \text{ A} \\ V_{CE(sat)} &= 2.7 \text{ V} \\ t_{fi typ} &= 150 \text{ ns} \end{aligned}$$

Symbol	Test Conditions	Maximum Ratings	
$V_{CES}$	$T_J = 25^\circ\text{C}$ to $150^\circ\text{C}$	900	V
$V_{CGR}$	$T_J = 25^\circ\text{C}$ to $150^\circ\text{C}$ ; $R_{GE} = 1 \text{ MW}$	900	V
$V_{GES}$	Continuous	$\pm 20$	V
$V_{GEM}$	Transient	$\pm 30$	V
$I_{C25}$	$T_C = 25^\circ\text{C}$	64	A
$I_{C110}$	$T_C = 110^\circ\text{C}$	32	A
$I_{CM}$	$T_C = 25^\circ\text{C}$ , 1 ms	200	A
<b>SSOA</b> <b>(RBSOA)</b>	$V_{GE} = 15 \text{ V}$ , $T_{VJ} = 125^\circ\text{C}$ , $R_G = 10 \Omega$ Clamped inductive load: $V_{CL} < 600\text{V}$	$I_{CM} = 64$	A
$P_C$	$T_C = 25^\circ\text{C}$	300	W
$T_J$		-55 ... +150	$^\circ\text{C}$
$T_{JM}$		150	$^\circ\text{C}$
$T_{stg}$		-55 ... +150	$^\circ\text{C}$
Maximum lead temperature for soldering 1.6 mm (0.062 in.) from case for 10 s		300	$^\circ\text{C}$
$M_d$	Mounting torque (TO-247)	1.13/10Nm/lb.in.	
<b>Weight</b>		TO-247	6 g
		TO-268	4 g

TO-247 (IXGH)

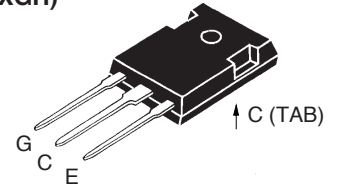

TO-268 (IXGT)

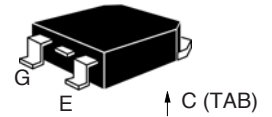

G = Gate      C = Collector  
E = Emitter    TAB = Collector

### Features

- High frequency IGBT
- High current handling capability
- MOS Gate turn-on  
- drive simplicity

### Applications

- PFC circuits
- Uninterruptible power supplies (UPS)
- Switched-mode and resonant-mode power supplies
- AC motor speed control
- DC servo and robot drives
- DC choppers

### Advantages

- High power density
- Very fast switching speeds for high frequency applications

Symbol	Test Conditions	Characteristic Values ( $T_J = 25^\circ\text{C}$ unless otherwise specified)		
		min.	typ.	max.
$V_{GE(th)}$	$I_C = 250 \text{ mA}$ , $V_{CE} = V_{GE}$	3.0		5.0 V
$I_{CES}$	$V_{CE} = V_{CES}$ $V_{GE} = 0 \text{ V}$ $T_J = 150^\circ\text{C}$			300 $\mu\text{A}$ 1.5 mA
$I_{GES}$	$V_{CE} = 0 \text{ V}$ , $V_{GE} = \pm 20 \text{ V}$			$\pm 100 \text{ nA}$
$V_{CE(sat)}$	$I_C = I_{C110}$ , $V_{GE} = 15 \text{ V}$ $T_J = 125^\circ\text{C}$	2.2	2.7	V
		2.1		V

Symbol	Test Conditions	Characteristic Values ( $T_J = 25^\circ\text{C}$ unless otherwise specified)			
		Min.	Typ.	Max.	
$g_{fs}$	$I_C = I_{C110}, V_{CE} = 10\text{ V}$ Pulse test, $t < 300\ \mu\text{s}$ , duty cycle $< 2\%$	18	28	S	
$C_{ies}$	$V_{CE} = 25\text{ V}, V_{GE} = 0\text{ V}, f = 1\text{ MHz}$		1790	pF	
$C_{oes}$			146	pF	
$C_{res}$			49	pF	
$Q_g$	$I_C = I_{C110}, V_{GE} = 15\text{ V}, V_{CE} = 0.5 V_{CES}$		89	nC	
$Q_{ge}$			15	nC	
$Q_{gc}$			34	nC	
$t_{d(on)}$	<b>Inductive load, <math>T_J = 25^\circ\text{C}</math></b> $I_C = I_{C110}, V_{GE} = 15\text{ V}$ $V_{CE} = 720\text{ V}, R_G = R_{off} = 5\ \Omega$		20	ns	
$t_{ri}$			22	ns	
$t_{d(off)}$			260	400	ns
$t_{fi}$			150		ns
$E_{off}$			2.2	4.5	mJ
$t_{d(on)}$	<b>Inductive load, <math>T_J = 125^\circ\text{C}</math></b> $I_C = I_{C110}\text{ A}, V_{GE} = 15\text{ V}$ $V_{CE} = 720\text{ V}, R_G = R_{off} = 5\ \Omega$		20	ns	
$t_{ri}$			22	ns	
$E_{on}$			3.8		mJ
$t_{d(off)}$			360		ns
$t_{fi}$			330		ns
$E_{off}$		5.75		mJ	
$R_{thJC}$				0.42	KW
$R_{thCS}$	(TO-247)		0.25		KW

### Ultrafast Diode

Symbol	Conditions	Maximum Ratings	
$I_{F110}$	$T_C = 110^\circ\text{C}$	27	A

Symbol	Conditions	Characteristic Values ( $T_J = 25^\circ\text{C}$ unless otherwise specified)			
		Min.	Typ.	Max.	
$V_F$	$I_F = 30\text{ A};$ $T_{VJ} = 125^\circ\text{C}$		1.9	2.75	V
$I_{RM}$	$I_F = 50\text{ A}; di_F/dt = -100\text{ A}/\mu\text{s}; T_{VJ} = 100^\circ\text{C}$ $V_R = 100\text{ V}; V_{GE} = 0\text{ V}$		5.5	11.4	A
$t_{rr}$			190		ns
$R_{thJC}$				0.9	K/W
$R_{thCS}$			0.25		K/W

### TO-247 AD Outline

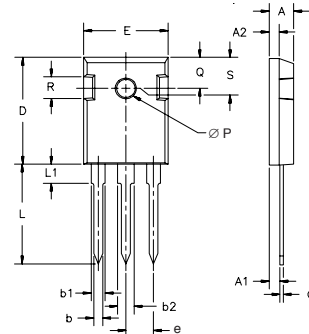

Dim.	Millimeter		Inches	
	Min.	Max.	Min.	Max.
A	4.7	5.3	.185	.209
A <sub>1</sub>	2.2	2.54	.087	.102
A <sub>2</sub>	2.2	2.6	.059	.098
b	1.0	1.4	.040	.055
b <sub>1</sub>	1.65	2.13	.065	.084
b <sub>2</sub>	2.87	3.12	.113	.123
C	.4	.8	.016	.031
D	20.80	21.46	.819	.845
E	15.75	16.26	.610	.640
e	5.20	5.72	0.205	0.225
L	19.81	20.32	.780	.800
L1		4.50		.177
∅P	3.55	3.65	.140	.144
Q	5.89	6.40	0.232	0.252
R	4.32	5.49	.170	.216
S	6.15	BSC	.242	BSC

### TO-268 Outline

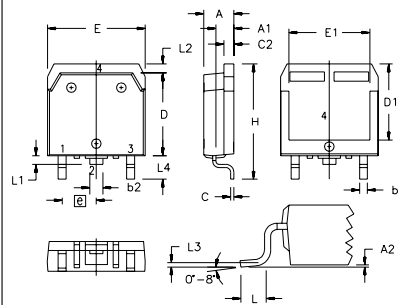

SYM	INCHES		MILLIMETERS	
	MIN	MAX	MIN	MAX
A	.193	.201	4.90	5.10
A1	.106	.114	2.70	2.90
A2	.001	.010	0.02	0.25
b	.045	.057	1.15	1.45
b2	.075	.083	1.90	2.10
C	.016	.026	0.40	0.65
C2	.057	.063	1.45	1.60
D	.543	.551	13.80	14.00
D1	.488	.500	12.40	12.70
E	.624	.632	15.85	16.05
E1	.524	.535	13.30	13.60
e		.215 BSC		5.45 BSC
H	.736	.752	18.70	19.10
L	.094	.106	2.40	2.70
L1	.047	.055	1.20	1.40
L2	.039	.045	1.00	1.15
L3	.010	BSC		0.25 BSC
L4	.150	.161	3.80	4.10

IXYS reserves the right to change limits, test conditions, and dimensions.

IXYS MOSFETs and IGBTs are covered by one or more of the following U.S. patents:	4,835,592	4,931,844	5,049,961	5,237,481	6,162,665	6,404,065 B1	6,683,344	6,727,585
	4,850,072	5,017,508	5,063,307	5,381,025	6,259,123 B1	6,534,343	6,710,405 B2	6,759,692
	4,881,106	5,034,796	5,187,117	5,486,715	6,306,728 B1	6,583,505	6,710,463	6,771,478 B2

**Fig. 1. Output Characteristics**  
@ 25 °C

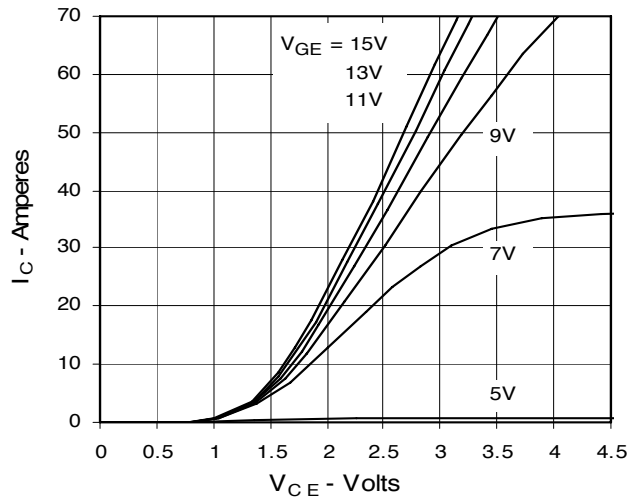

**Fig. 2. Extended Output Characteristics**  
@ 25 °C

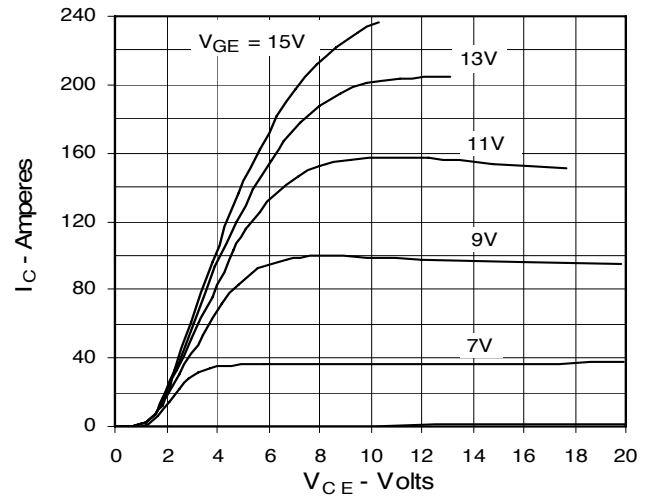

**Fig. 3. Output Characteristics**  
@ 125 °C

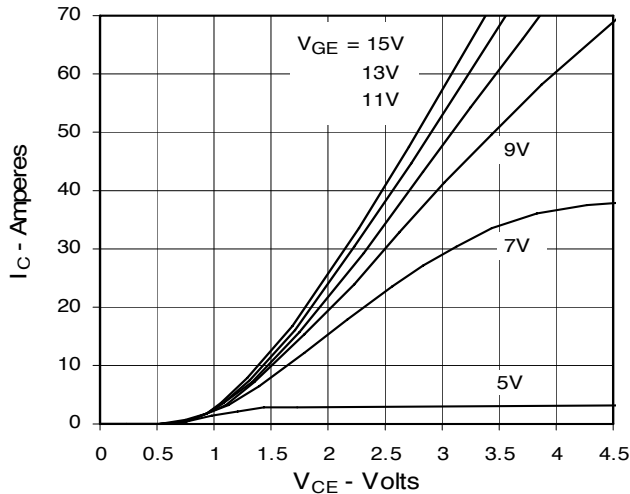

**Fig. 4. Dependence of  $V_{CE(sat)}$  on Temperature**

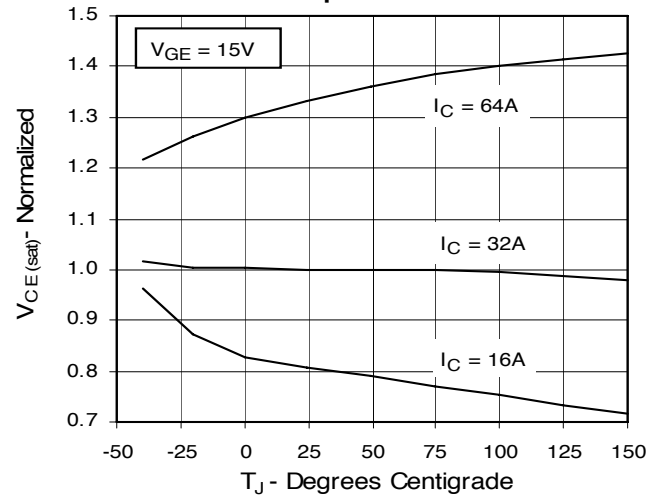

**Fig. 5. Collector-to-Emitter Voltage vs. Gate-to-Emitter voltage**

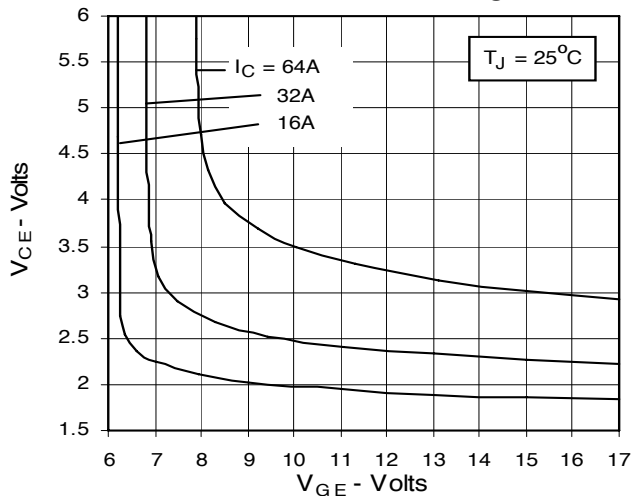

**Fig. 6. Input Admittance**

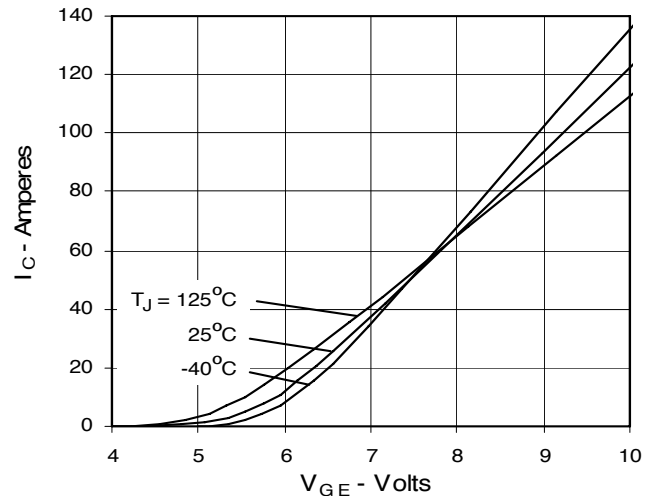

Fig. 7. Transconductance

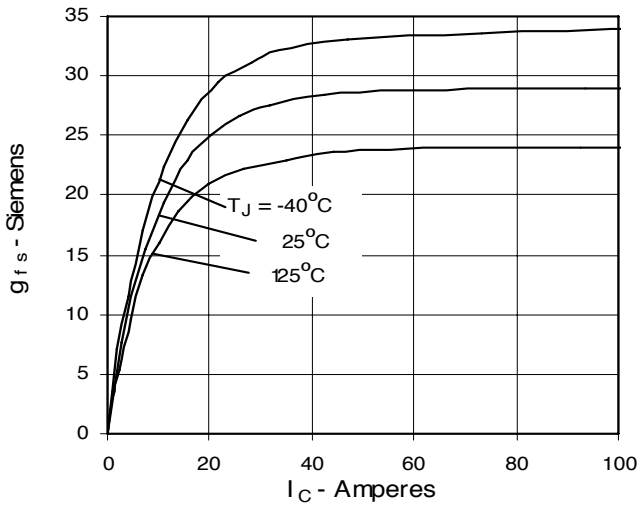

Fig. 8. Gate Charge

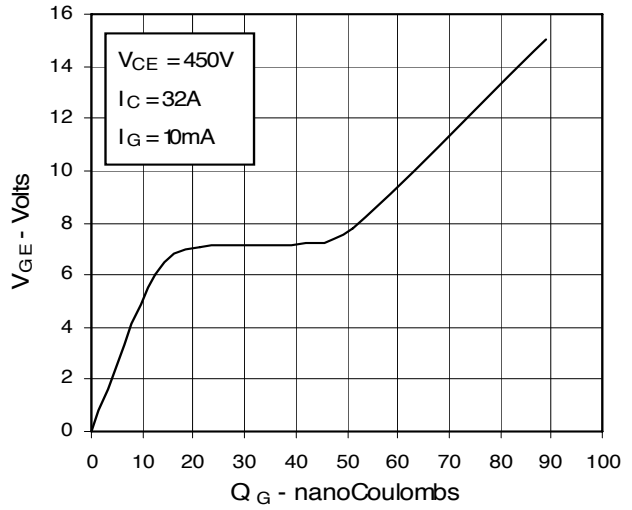

Fig. 9. Capacitance

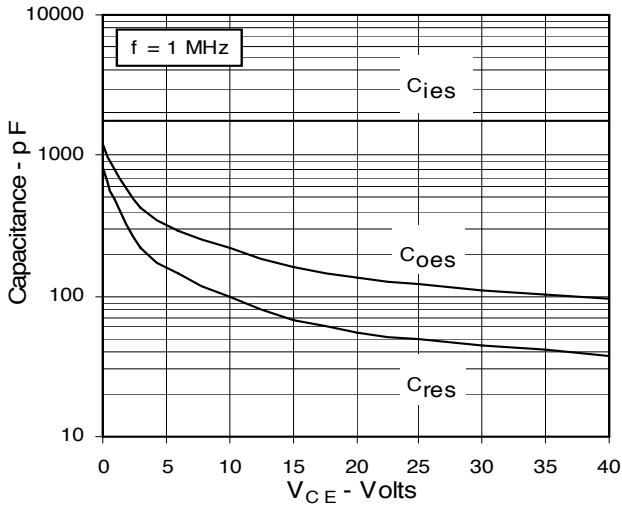

Fig. 10. Reverse-Bias Safe Operating Area

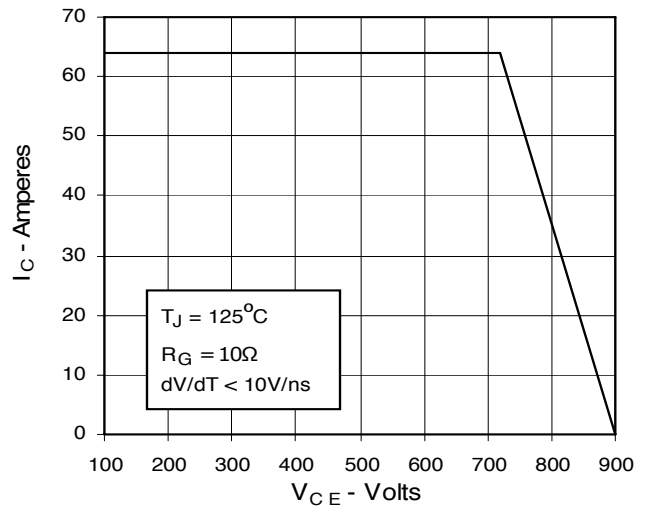
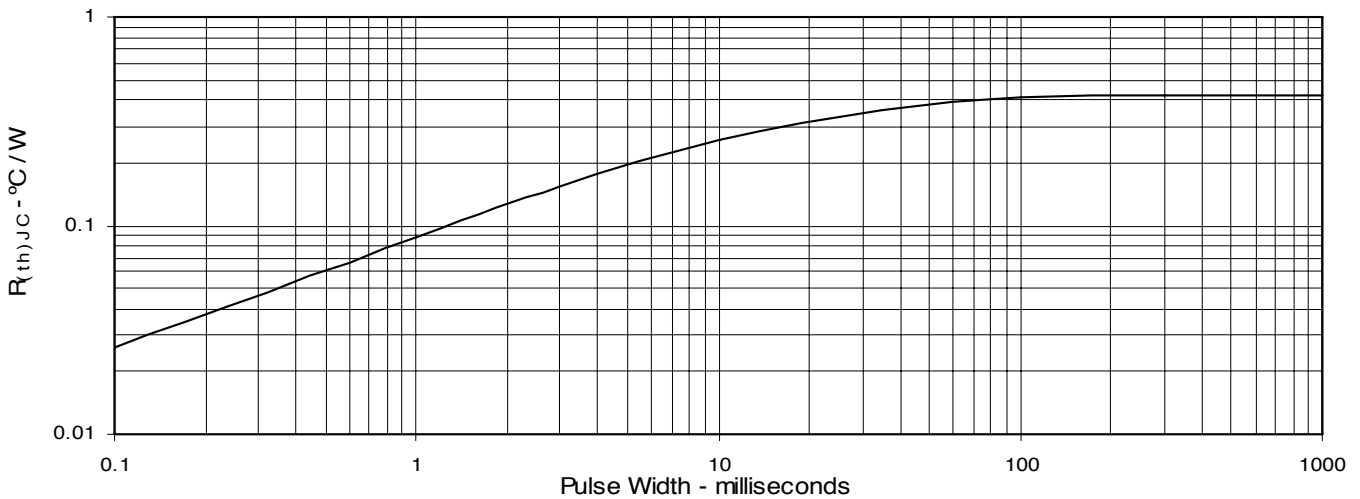
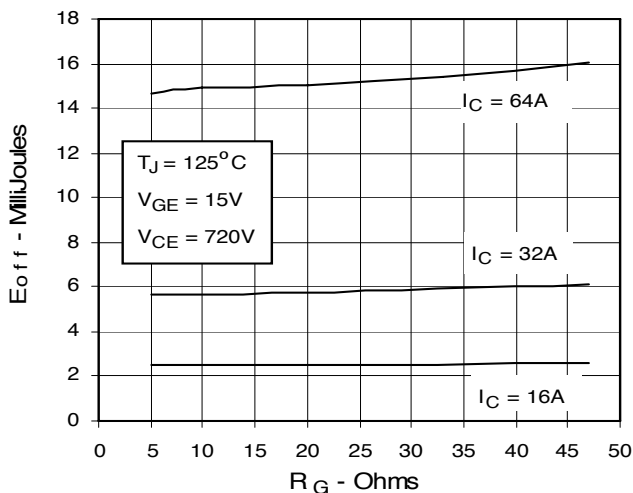

Fig. 11. Maximum Transient Thermal Resistance



**Fig. 12. Dependence of Turn-off Energy Loss on Gate Resistance**



**Fig. 13. Dependence of Turn-on Energy Loss on Gate Resistance**

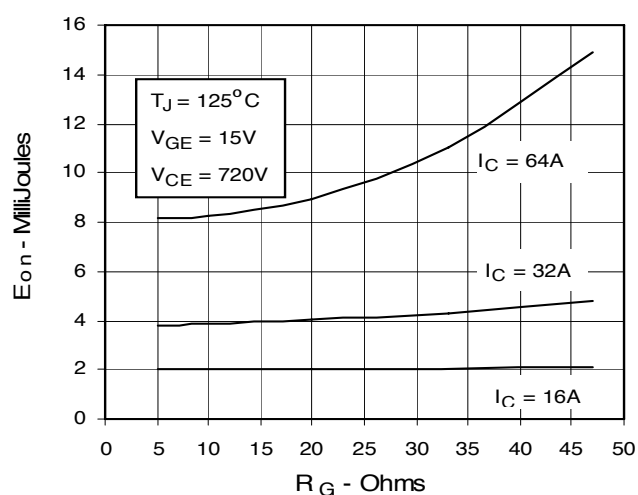

**Fig. 14. Dependence of Turn-off Energy Loss on Collector Current**

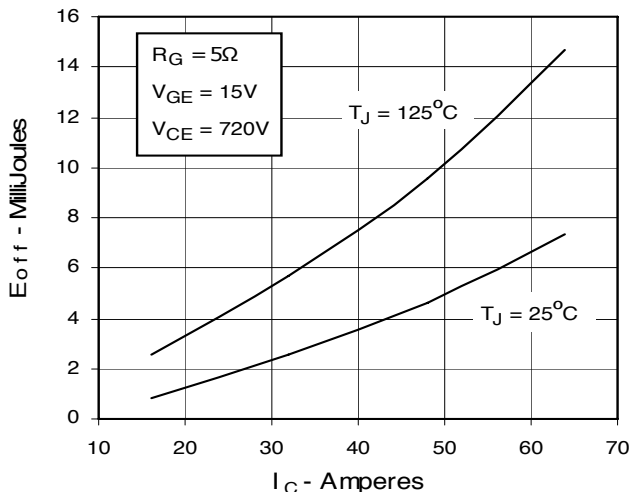

**Fig. 15. Dependence of Turn-on Energy Loss on Collector Current**

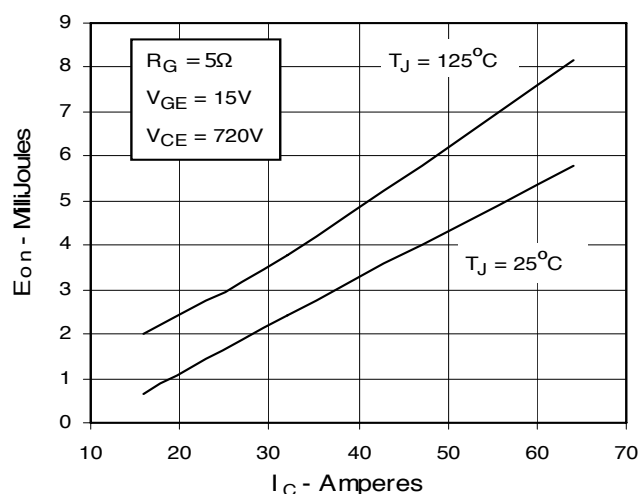

**Fig. 16. Dependence of Turn-off Energy Loss on Temperature**

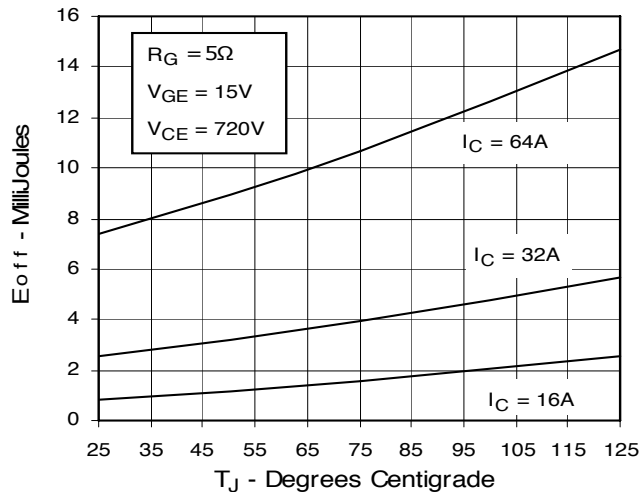

**Fig. 17. Dependence of Turn-on Energy Loss on Temperature**

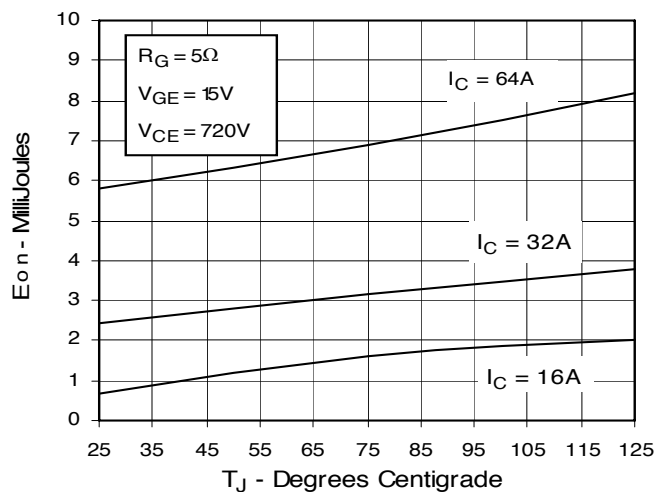

**Fig. 18. Dependence of Turn-off Switching Time on Gate Resistance**

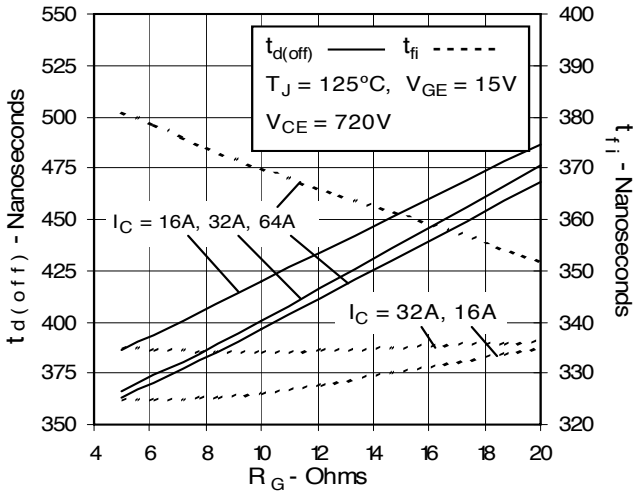

**Fig. 19. Dependence of Turn-on Switching Time on Gate Resistance**

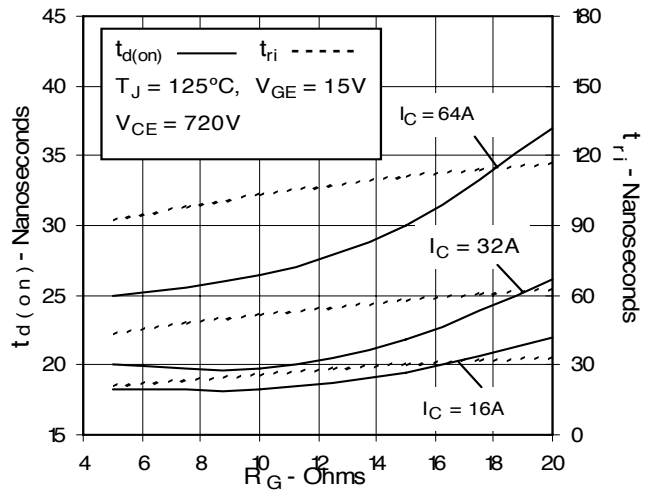

**Fig. 20. Dependence of Turn-off Switching Time on Collector Current**

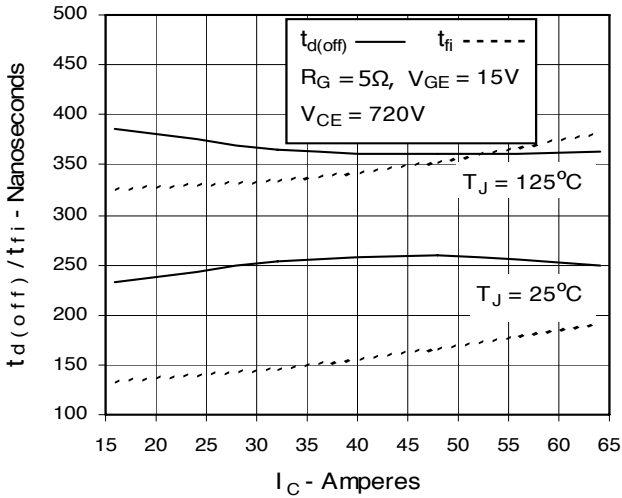

**Fig. 21. Dependence of Turn-on Switching Time on Collector Current**

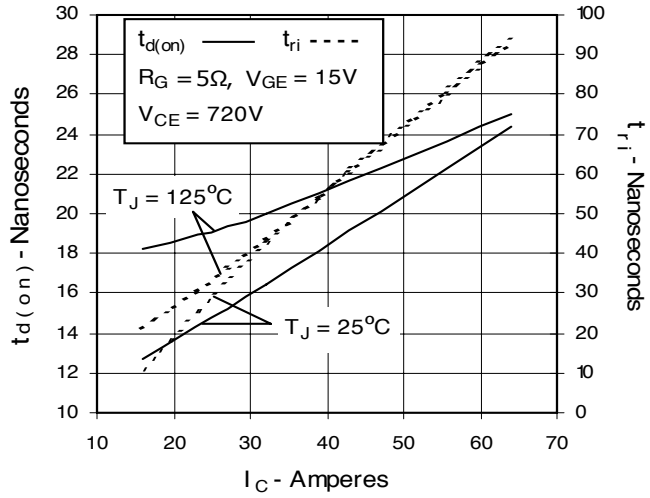

**Fig. 22. Dependence of Turn-off Switching Time on Temperature**

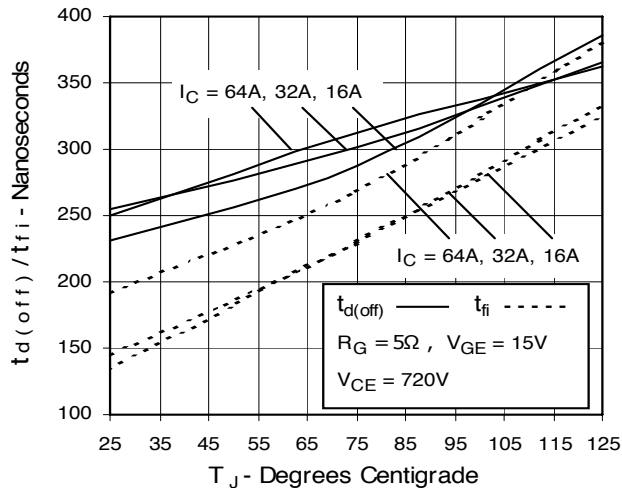

**Fig. 23. Dependence of Turn-on Switching Time on Temperature**

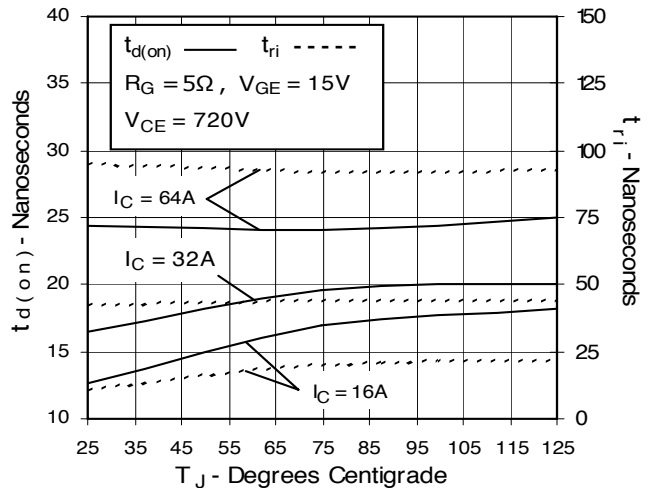

Ultrafast Diode Characteristic Curves

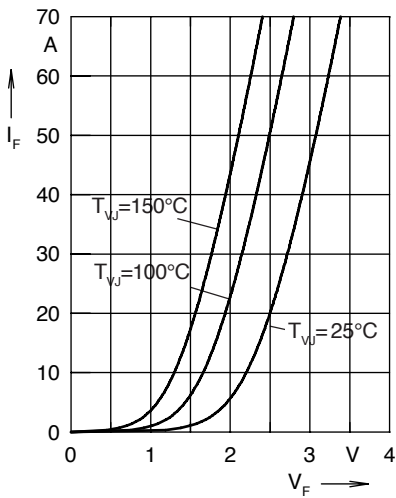

Fig. 24. Forward current  $I_F$  versus  $V_F$

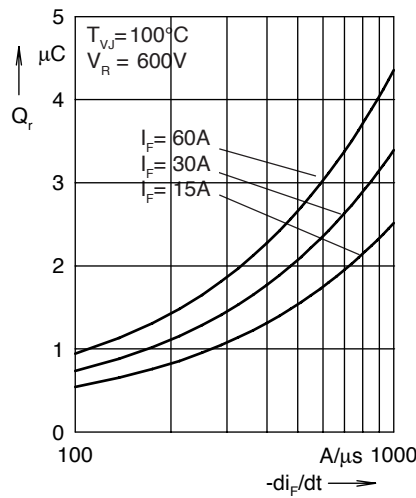

Fig. 25. Reverse recovery charge  $Q_r$  versus  $-di_F/dt$

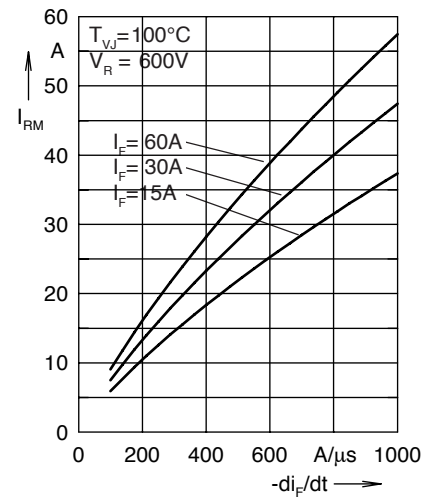

Fig. 26. Peak reverse current  $I_{RM}$  versus  $-di_F/dt$

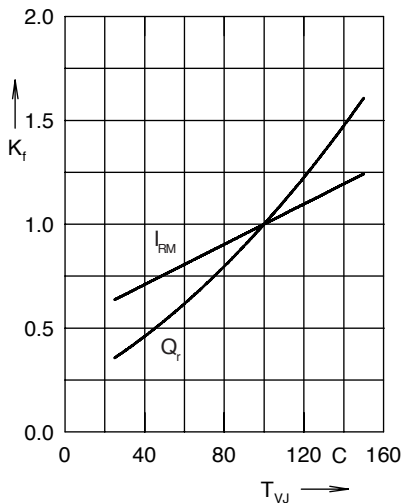

Fig. 27. Dynamic parameters  $Q_r$ ,  $I_{RM}$  versus  $T_{VJ}$

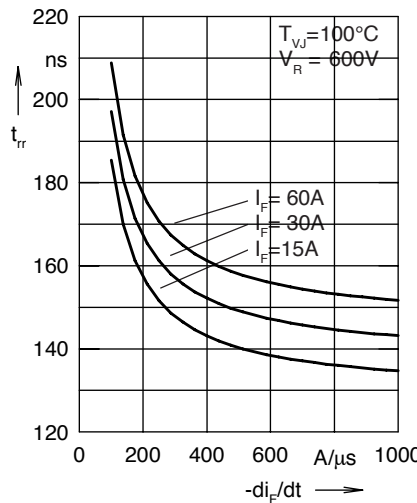

Fig. 28. Recovery time  $t_{tr}$  versus  $-di_F/dt$

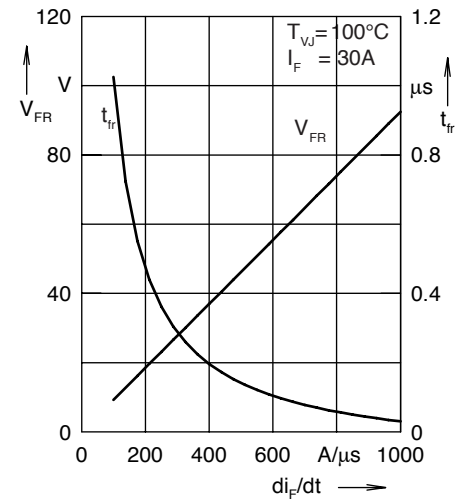

Fig. 29. Peak forward voltage  $V_{FR}$  and  $t_{tr}$  versus  $di_F/dt$

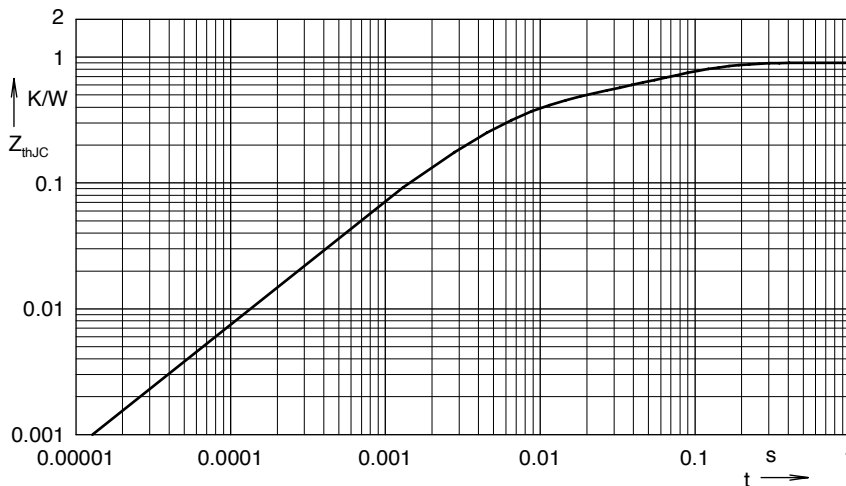

Fig. 30. Transient thermal resistance junction to case

Constants for  $Z_{thJC}$  calculation:

i	$R_{thi}$ (K/W)	$t_i$ (s)
1	0.465	0.0052
2	0.179	0.0003
3	0.256	0.0397