

# HiPerFAST™ IGBT

## C2-Class High Speed IGBTs

**IXGH 40N60C2**  
**IXGT 40N60C2**

**V<sub>CES</sub> = 600 V**  
**I<sub>C25</sub> = 75 A**  
**V<sub>CE(sat)</sub> = 2.7 V**  
**t<sub>fi</sub>typ = 32 ns**

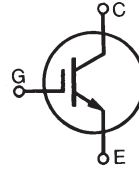

Symbol	Test Conditions	Maximum Ratings	
V <sub>CES</sub>	T <sub>J</sub> = 25°C to 150°C	600	V
V <sub>CGR</sub>	T <sub>J</sub> = 25°C to 150°C; R <sub>GE</sub> = 1 MΩ	600	V
V <sub>GES</sub>	Continuous	±20	V
V <sub>GEM</sub>	Transient	±30	V
I <sub>C25</sub>	T <sub>C</sub> = 25°C (limited by leads)	75	A
I <sub>C110</sub>	T <sub>C</sub> = 110°C	40	A
I <sub>CM</sub>	T <sub>C</sub> = 25°C, 1 ms	200	A
<b>SSOA</b>	V <sub>GE</sub> = 15 V, T <sub>VJ</sub> = 125°C, R <sub>G</sub> = 10 Ω	I <sub>CM</sub> = 80	A
<b>(RBSOA)</b>	Clamped inductive load @ ≤ 600 V		
P <sub>C</sub>	T <sub>C</sub> = 25°C	300	W
T <sub>J</sub>		-55 ... +150	°C
T <sub>JM</sub>		150	°C
T <sub>stg</sub>		-55 ... +150	°C
	Maximum lead temperature for soldering 1.6 mm (0.062 in.) from case for 10 s	300	°C
	Plastic body	200	°C
M <sub>d</sub>	Mounting torque (M3)	1.13/10Nm/lb.in.	
Weight		TO-247	6 g
		TO-268	4 g

TO-268 (IXGT)

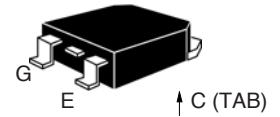

TO-247 (IXGH)

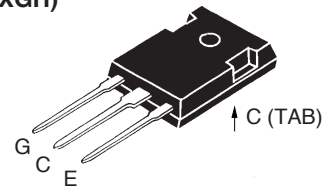

G = Gate, C = Collector,  
E = Emitter, TAB = Collector

### Features

- Very high frequency IGBT
- Square RBSOA
- High current handling capability
- MOS Gate turn-on - drive simplicity

### Applications

- PFC circuits
- Uninterruptible power supplies (UPS)
- Switched-mode and resonant-mode power supplies
- AC motor speed control
- DC servo and robot drives
- DC choppers

### Advantages

- High power density
- Very fast switching speeds for high frequency applications

Symbol	Test Conditions	Characteristic Values (T <sub>J</sub> = 25°C unless otherwise specified)		
		min.	typ.	max.
V <sub>GE(th)</sub>	I <sub>C</sub> = 250 μA, V <sub>CE</sub> = V <sub>GE</sub>	3.0		5.0 V
I <sub>CES</sub>	V <sub>CE</sub> = V <sub>CES</sub> V <sub>GE</sub> = 0 V			50 μA 1 mA
I <sub>GES</sub>	V <sub>CE</sub> = 0 V, V <sub>GE</sub> = ±20 V			±100 nA
V <sub>CE(sat)</sub>	I <sub>C</sub> = 30 A, V <sub>GE</sub> = 15 V		2.2 2.0	2.7 V V

Symbol	Test Conditions	Characteristic Values ( $T_J = 25^\circ\text{C}$ unless otherwise specified)			
		min.	typ.	max.	
$g_{fs}$	$I_C = 30\text{ A}; V_{CE} = 10\text{ V}$ , Pulse test, $t \leq 300\ \mu\text{s}$ , duty cycle $\leq 2\%$	20	36	S	
$C_{ies}$ $C_{oes}$ $C_{res}$	$V_{CE} = 25\text{ V}, V_{GE} = 0\text{ V}, f = 1\text{ MHz}$		2500	pF	
			180	pF	
			54	pF	
$Q_g$ $Q_{ge}$ $Q_{gc}$	$I_C = 30\text{ A}, V_{GE} = 15\text{ V}, V_{CE} = 300\text{ V}$		95	nC	
			14	nC	
			36	nC	
$t_{d(on)}$ $t_{ri}$ $t_{d(off)}$ $t_{fi}$ $E_{off}$	<b>Inductive load, <math>T_J = 25^\circ\text{C}</math></b> $I_C = 30\text{ A}, V_{GE} = 15\text{ V}$ $V_{CE} = 400\text{ V}, R_G = R_{off} = 3\ \Omega$		18	ns	
			20	ns	
			90	140	ns
			32	ns	
			0.20	0.37	mJ
$t_{d(on)}$ $t_{ri}$ $E_{on}$ $t_{d(off)}$ $t_{fi}$ $E_{off}$	<b>Inductive load, <math>T_J = 125^\circ\text{C}</math></b> $I_C = 30\text{ A}, V_{GE} = 15\text{ V}$ $V_{CE} = 400\text{ V}, R_G = R_{off} = 3\ \Omega$		18	ns	
			20	ns	
			0.3	mJ	
			130	ns	
			80	240	ns
			0.50	mJ	
$R_{thJC}$ $R_{thCK}$	(TO-247)			0.42 KW KW	
		0.25			

### Min. Recommended Footprint (Dimensions in inches and mm)

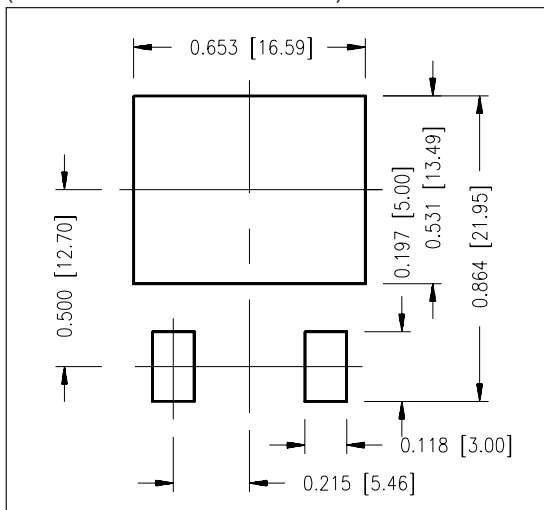

### TO-247 AD Outline

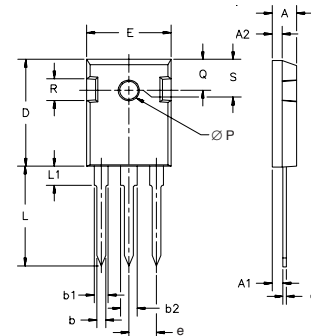

Dim.	Millimeter		Inches	
	Min.	Max.	Min.	Max.
A	4.7	5.3	.185	.209
A <sub>1</sub>	2.2	2.54	.087	.102
A <sub>2</sub>	2.2	2.6	.059	.098
b	1.0	1.4	.040	.055
b <sub>1</sub>	1.65	2.13	.065	.084
b <sub>2</sub>	2.87	3.12	.113	.123
C	.4	.8	.016	.031
D	20.80	21.46	.819	.845
E	15.75	16.26	.610	.640
e	5.20	5.72	0.205	0.225
L	19.81	20.32	.780	.800
L1		4.50		.177
∅P	3.55	3.65	.140	.144
Q	5.89	6.40	0.232	0.252
R	4.32	5.49	.170	.216
S	6.15	BSC	.242	BSC

### TO-268 Outline

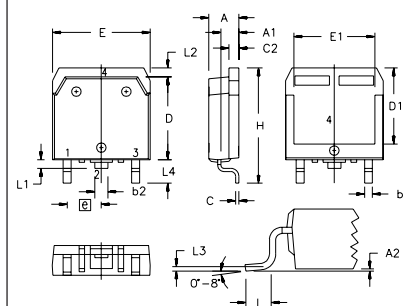

SYM	INCHES		MILLIMETERS	
	MIN	MAX	MIN	MAX
A	.193	.201	4.90	5.10
A1	.106	.114	2.70	2.90
A2	.001	.010	0.02	0.25
b	.045	.057	1.15	1.45
b2	.075	.083	1.90	2.10
C	.016	.026	0.40	0.65
C2	.057	.063	1.45	1.60
D	.543	.551	13.80	14.00
D1	.488	.500	12.40	12.70
E	.624	.632	15.85	16.05
E1	.524	.535	13.30	13.60
e	.215 BSC		5.45 BSC	
H	.736	.752	18.70	19.10
L	.094	.106	2.40	2.70
L1	.047	.055	1.20	1.40
L2	.039	.045	1.00	1.15
L3	.010 BSC		0.25 BSC	
L4	.150	.161	3.80	4.10

IXYS reserves the right to change limits, test conditions, and dimensions.

IXYS MOSFETs and IGBTs are covered by one or more of the following U.S. patents:	4,835,592	4,931,844	5,049,961	5,237,481	6,162,665	6,404,065 B1	6,683,344	6,727,585
	4,850,072	5,017,508	5,063,307	5,381,025	6,259,123 B1	6,534,343	6,710,405 B2	6,759,692
	4,881,106	5,034,796	5,187,117	5,486,715	6,306,728 B1	6,583,505	6,710,463	6,771,478 B2

**Fig. 1. Output Characteristics**  
@ 25 Deg. C

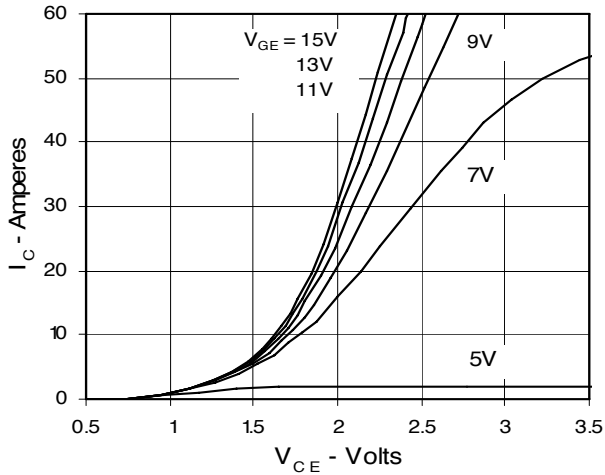

**Fig. 2. Extended Output Characteristics**  
@ 25 deg. C

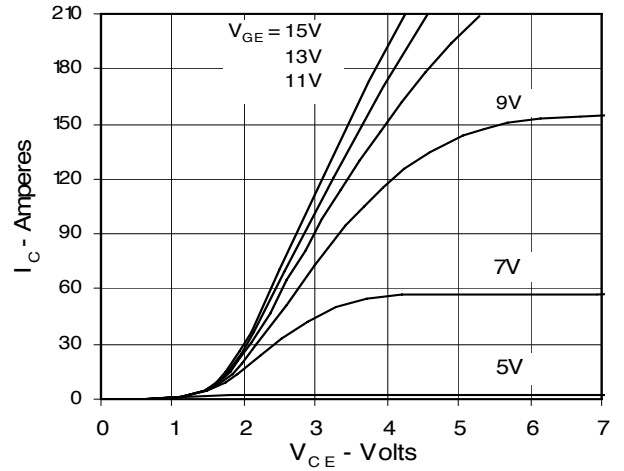

**Fig. 3. Output Characteristics**  
@ 125 Deg. C

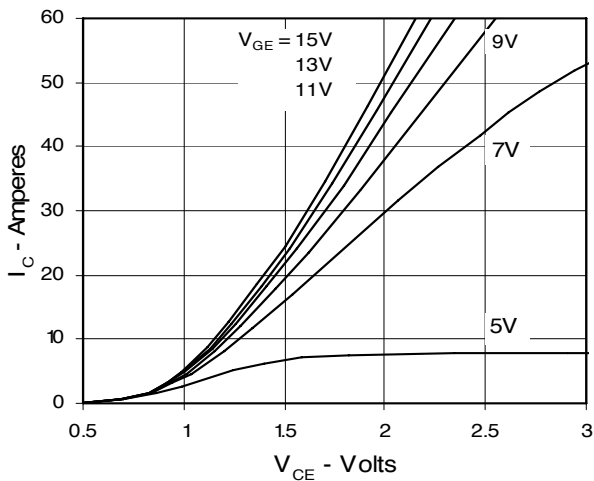

**Fig. 4. Temperature Dependence of  $V_{CE(sat)}$**

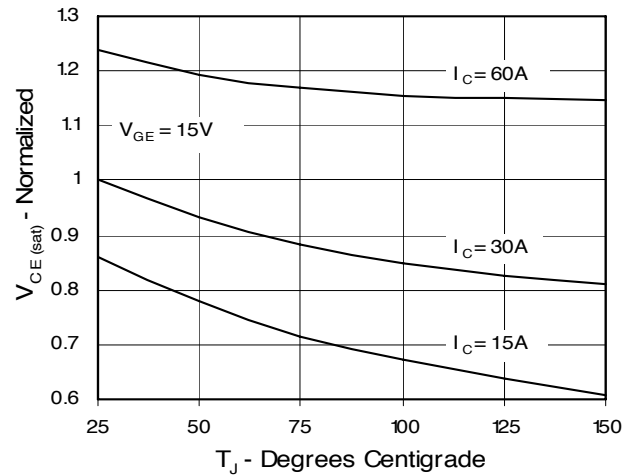

**Fig. 5. Collector-to-Emitter Voltage vs. Gate-to-Emitter voltage**

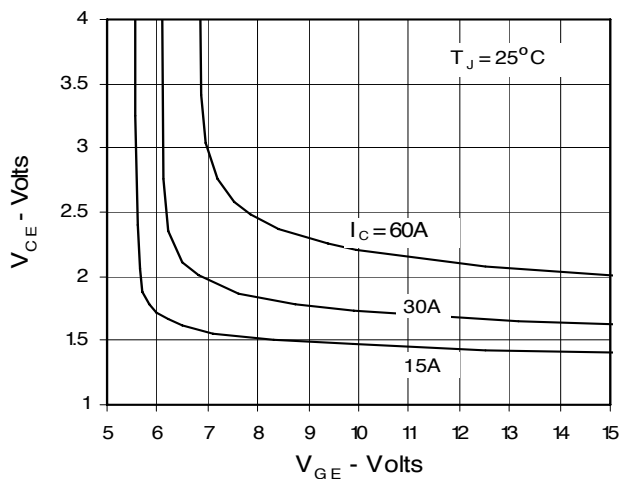

**Fig. 6. Input Admittance**

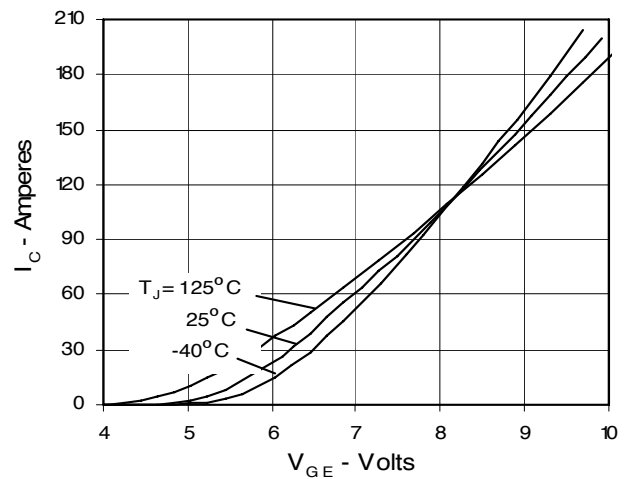

Fig. 7. Transconductance

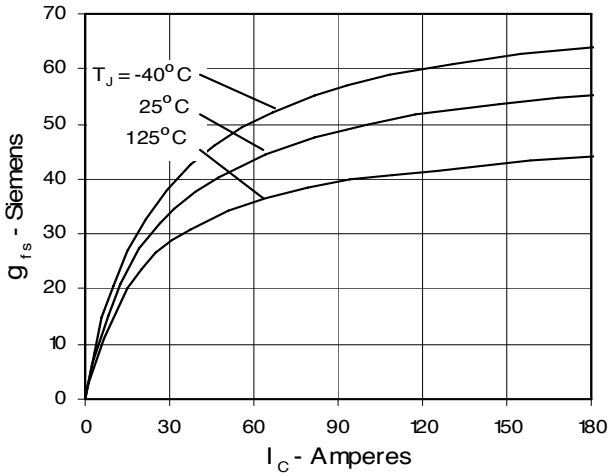

Fig. 8. Dependence of  $E_{off}$  on  $R_G$

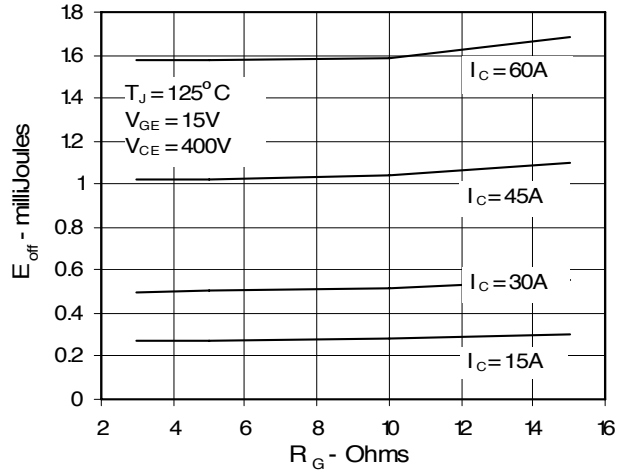

Fig. 9. Dependence of  $E_{off}$  on  $I_C$

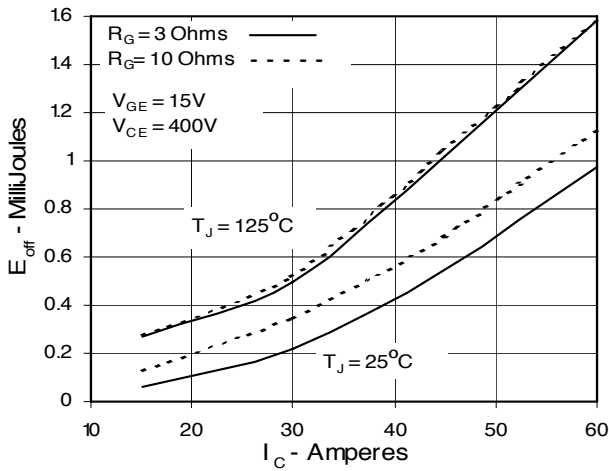

Fig. 10. Dependence of  $E_{off}$  on Temperature

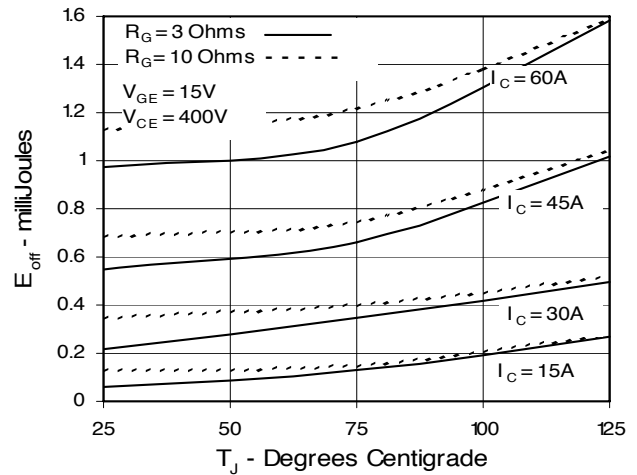

Fig. 11. Gate Charge

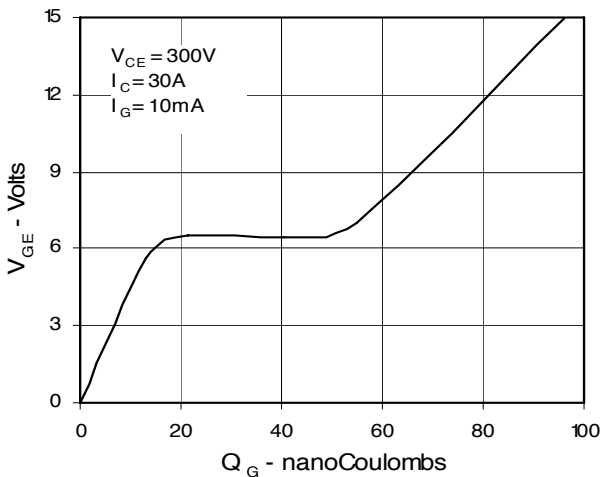

Fig. 12. Capacitance

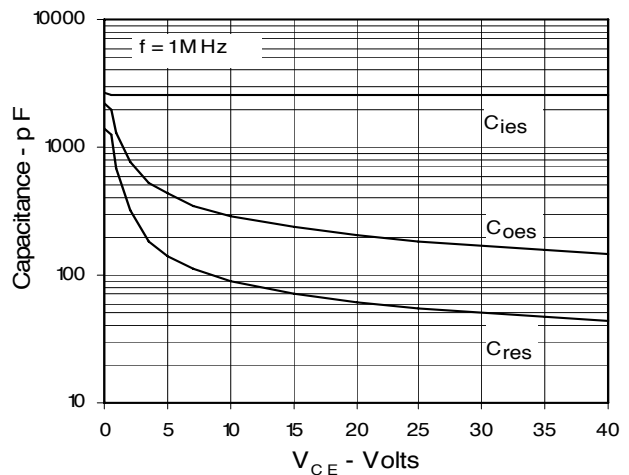

Fig. 13. Maximum Transient Thermal Resistance

