

# GenX3™ 600V IGBT with Diode

## IXGH48N60B3D1

Medium speed low  $V_{sat}$  PT IGBTs 5-40 kHz switching



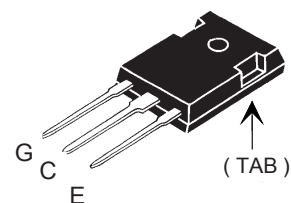
$$V_{CES} = 600V$$

$$I_{C110} = 48A$$

$$V_{CE(sat)} \leq 1.8V$$

Symbol	Test Conditions	Maximum Ratings	
$V_{CES}$	$T_C = 25^\circ C$ to $150^\circ C$	600	V
$V_{CGR}$	$T_J = 25^\circ C$ to $150^\circ C$ , $R_{GE} = 1M\Omega$	600	V
$V_{GES}$	Continuous	$\pm 20$	V
$V_{GEM}$	Transient	$\pm 30$	V
$I_{C110}$	$T_C = 110^\circ C$	48	A
$I_{D110}$	$T_C = 110^\circ C$	30	A
$I_{CM}$	$T_C = 25^\circ C$ , 1ms	280	A
<b>SSOA</b>	$V_{GE} = 15V$ , $T_{VJ} = 125^\circ C$ , $R_G = 5\Omega$	$I_{CM} = 120$	A
<b>(RBSOA)</b>	Clamped inductive load @ $\leq 600V$		
$P_C$	$T_C = 25^\circ C$	300	W
$T_J$		-55 ... +150	$^\circ C$
$T_{JM}$		150	$^\circ C$
$T_{stg}$		-55 ... +150	$^\circ C$
$T_L$	1.6mm (0.062 in.) from case for 10s	300	$^\circ C$
$T_{SOLD}$	Plastic body for 10 seconds	260	$^\circ C$
$M_d$	Mounting torque	1.13/10	Nm/lb.in.
<b>Weight</b>		6	g

### TO-247(IXGH)



G = Gate      C = Collector  
E = Emitter    TAB = Collector

### Features

- Optimized for low conduction and switching losses
- Square RBSOA
- Anti-parallel ultra fast diode
- International standard package

### Advantages

- High power density
- Low gate drive requirement

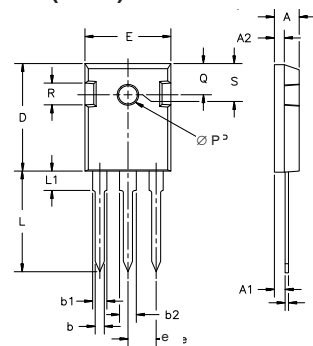
### Applications

- Power Inverters
- UPS
- Motor Drives
- SMPS
- PFC Circuits
- Battery Chargers
- Welding Machines
- Lamp Ballasts

Symbol	Test Conditions ( $T_J = 25^\circ C$ unless otherwise specified)	Characteristic Values		
		Min.	Typ.	Max.
$BV_{CES}$	$I_C = 250\mu A$ , $V_{GE} = 0V$	600		V
$V_{GE(th)}$	$I_C = 250\mu A$ , $V_{CE} = V_{GE}$	3.0		5.0 V
$I_{CES}$	$V_{CE} = V_{CES}$ $V_{GE} = 0V$ $T_J = 125^\circ C$			300 $\mu A$ 1.75 mA
$I_{GES}$	$V_{CE} = 0V$ , $V_{GE} = \pm 20V$			$\pm 100$ nA
$V_{CE(sat)}$	$I_C = 32A$ , $V_{GE} = 15V$ , Note 1			1.8 V

Symbol	Test Conditions	Characteristic Values		
		Min.	Typ.	Max.
$g_{fs}$	$I_C = 30A, V_{CE} = 10V$ , Note 1	28	46	S
$C_{ies}$	$V_{CE} = 25V, V_{GE} = 0V, f = 1MHz$		3980	pF
$C_{oes}$			190	pF
$C_{res}$			45	pF
$Q_g$	$I_C = 40A, V_{GE} = 15V, V_{CE} = 0.5 \cdot V_{CES}$		115	nC
$Q_{ge}$			21	nC
$Q_{gc}$			40	nC
$t_{d(on)}$	<b>Inductive Load, <math>T_J = 25^\circ C</math></b> $I_C = 30A, V_{GE} = 15V$ $V_{CE} = 480V, R_G = 5\Omega$		22	ns
$t_{ri}$			25	ns
$E_{on}$			0.84	mJ
$t_{d(off)}$			130	200 ns
$t_{fi}$			116	200 ns
$E_{off}$		0.66	1.20 mJ	
$t_{d(on)}$	<b>Inductive Load, <math>T_J = 125^\circ C</math></b> $I_C = 30A, V_{GE} = 15V$ $V_{CE} = 480V, R_G = 5\Omega$		19	ns
$t_{ri}$			25	ns
$E_{on}$			1.71	mJ
$t_{d(off)}$			190	ns
$t_{fi}$			157	ns
$E_{off}$		1.30	mJ	
$R_{thJC}$			0.42	$^\circ C/W$
$R_{thCS}$		0.21		$^\circ C/W$

TO-247 (IXGH) Outline



Dim.	Millimeter		Inches	
	Min.	Max.	Min.	Max.
A	4.7	5.3	.185	.209
A <sub>1</sub>	2.2	2.54	.087	.102
A <sub>2</sub>	2.2	2.6	.059	.098
b	1.0	1.4	.040	.055
b <sub>1</sub>	1.65	2.13	.065	.084
b <sub>2</sub>	2.87	3.12	.113	.123
C	.4	.8	.016	.031
D	20.80	21.46	.819	.845
E	15.75	16.26	.610	.640
e	5.20	5.72	0.205	0.225
L	19.81	20.32	.780	.800
L1		4.50		.177
∅P	3.55	3.65	.140	.144
Q	5.89	6.40	0.232	0.252
R	4.32	5.49	.170	.216
S	6.15	BSC	242	BSC

**Reverse Diode (FRED) (D1 Version ONLY)**

Symbol	Test Conditions	Characteristic Values		
		Min.	Typ.	Max.
$V_F$	$I_F = 30A, V_{GE} = 0V$ , Note 1		1.6	2.8 V
		$T_J = 150^\circ C$		V
$I_{RM}$	$I_F = 30A, V_{GE} = 0V, V_R = 100V$ $-di_F/dt = 100A/\mu s$		4	A
$t_{rr}$	$I_F = 1A; -di/dt = 100A/\mu s, V_R = 30V$ $T_J = 100^\circ C$		100	ns
$R_{thJC}$			1.5	$^\circ C/W$
$R_{thCS}$			1.5	$^\circ C/W$

Note 1: Pulse test,  $t \leq 300\mu s$ ; duty cycle,  $d \leq 2\%$ .

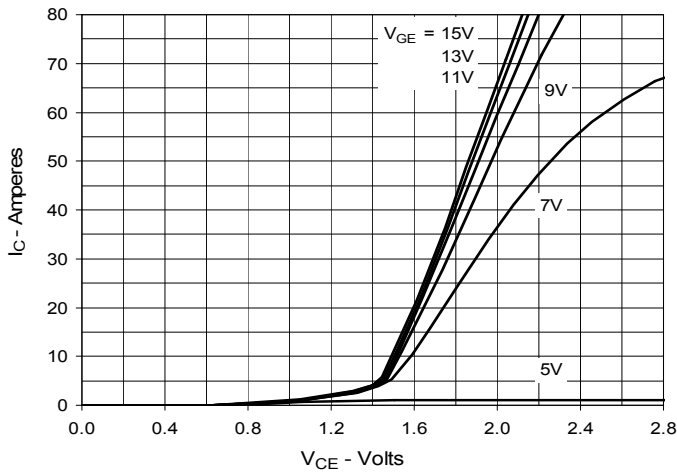
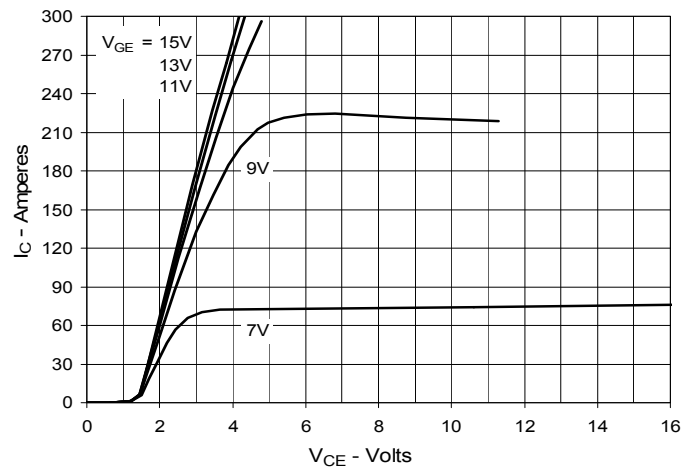
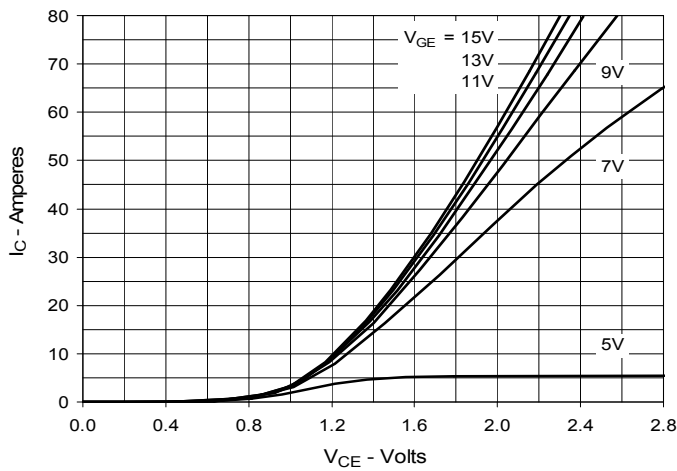
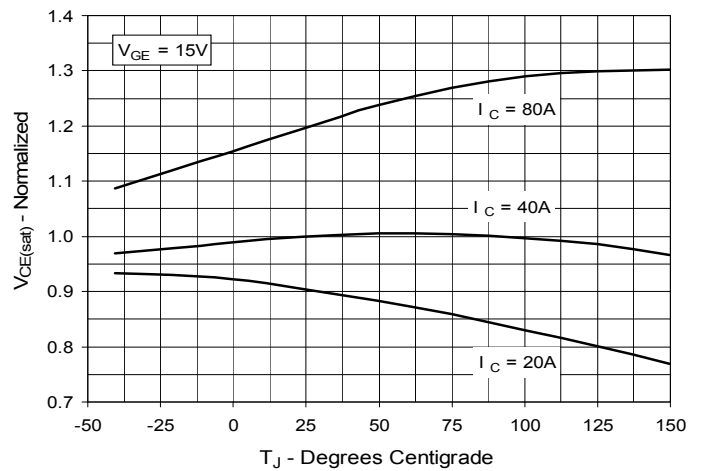
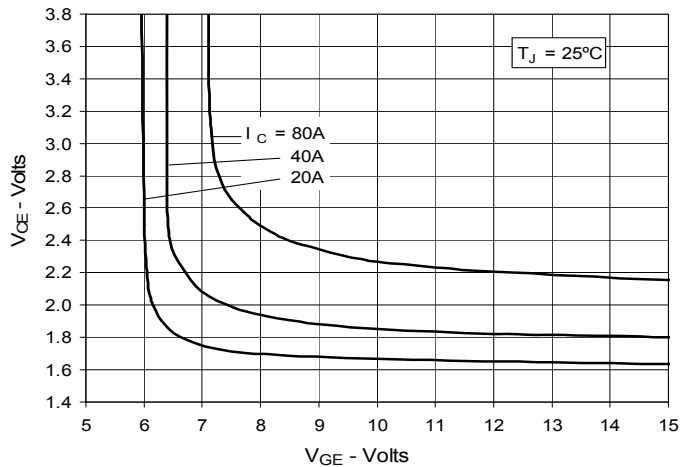
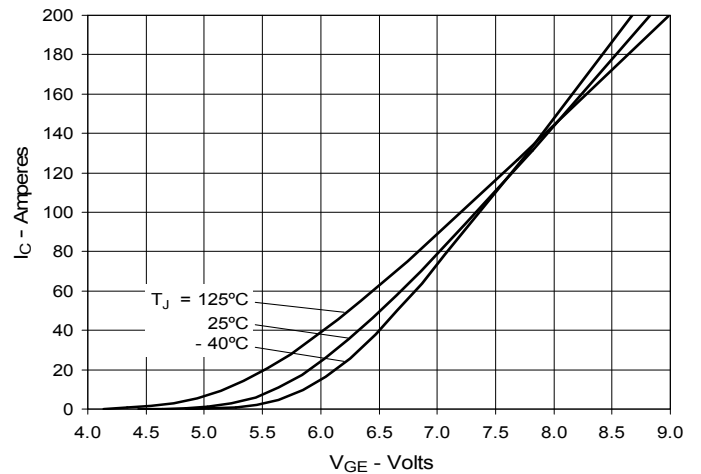
**PRELIMINARY TECHNICAL INFORMATION**

The product presented herein is under development. The Technical Specifications offered are derived from data gathered during objective characterizations of preliminary engineering lots; but also may yet contain some information supplied during a pre-production design evaluation. IXYS reserves the right to change limits, test conditions, and dimensions without notice.

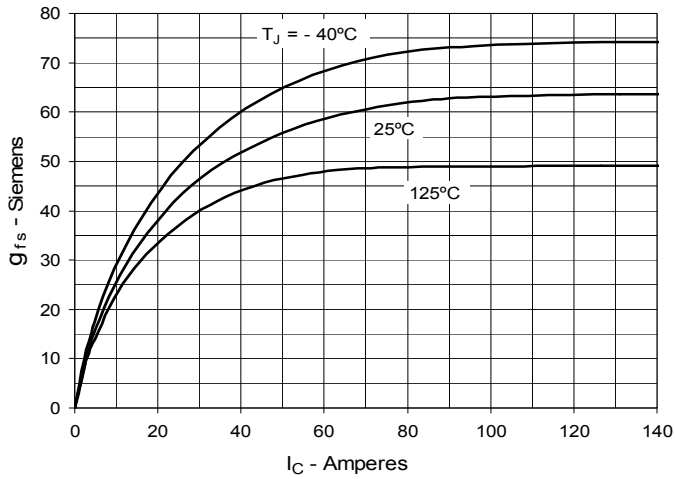
IXYS reserves the right to change limits, test conditions and dimensions.

IXYS MOSFETs and IGBTs are covered by one or more of the following U.S. patents:

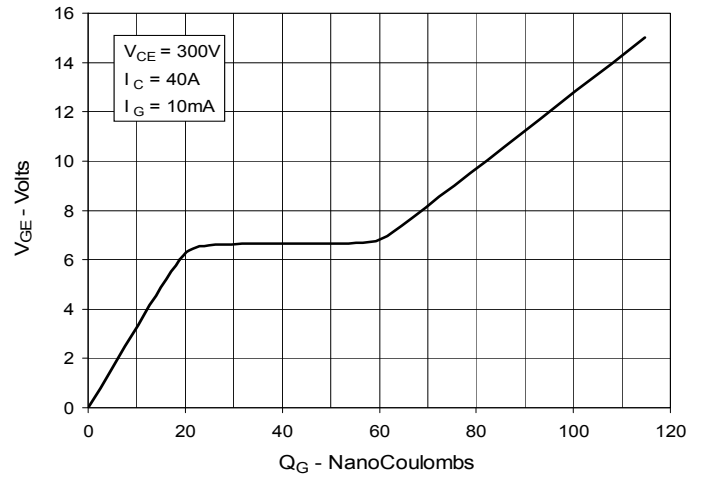
4,835,592	4,931,844	5,049,961	5,237,481	6,162,665	6,404,065 B1	6,683,344	6,727,585	7,005,734 B2	7,157,338B2
4,850,072	5,017,508	5,063,307	5,381,025	6,259,123 B1	6,534,343	6,710,405 B2	6,759,692	7,063,975 B2	
4,881,106	5,034,796	5,187,117	5,486,715	6,306,728 B1	6,583,505	6,710,463	6,771,478 B2	7,071,537	

**Fig. 1. Output Characteristics @ 25°C**

**Fig. 2. Extended Output Characteristics @ 25°C**

**Fig. 3. Output Characteristics @ 125°C**

**Fig. 4. Dependence of  $V_{CE(sat)}$  on Junction Temperature**

**Fig. 5. Collector-to-Emitter Voltage vs. Gate-to-Emitter Voltage**

**Fig. 6. Input Admittance**


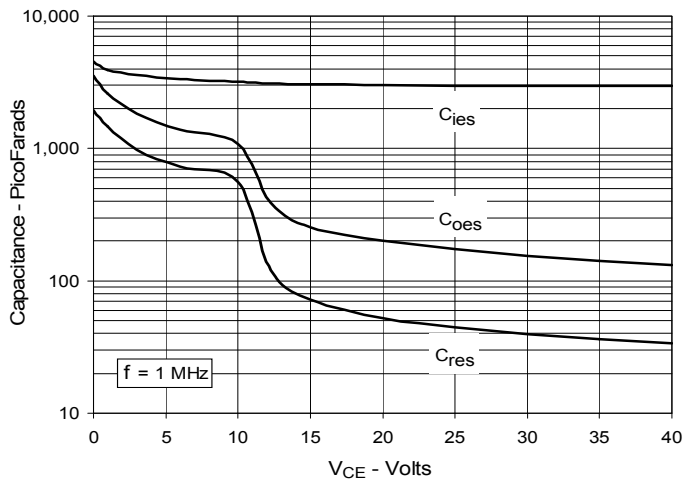
**Fig. 7. Transconductance**



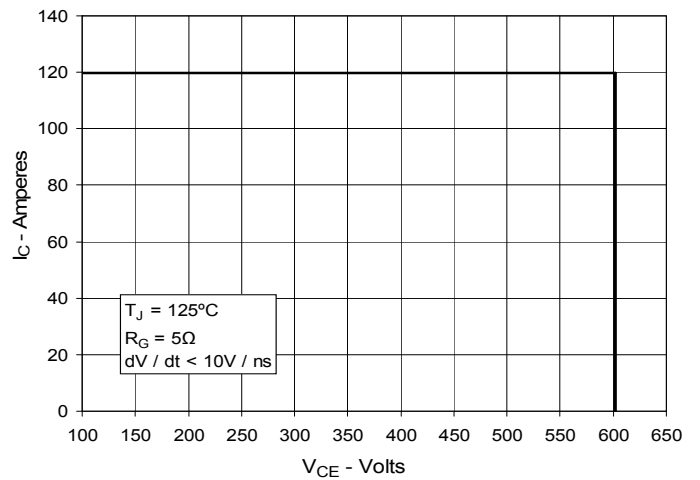
**Fig. 8. Gate Charge**



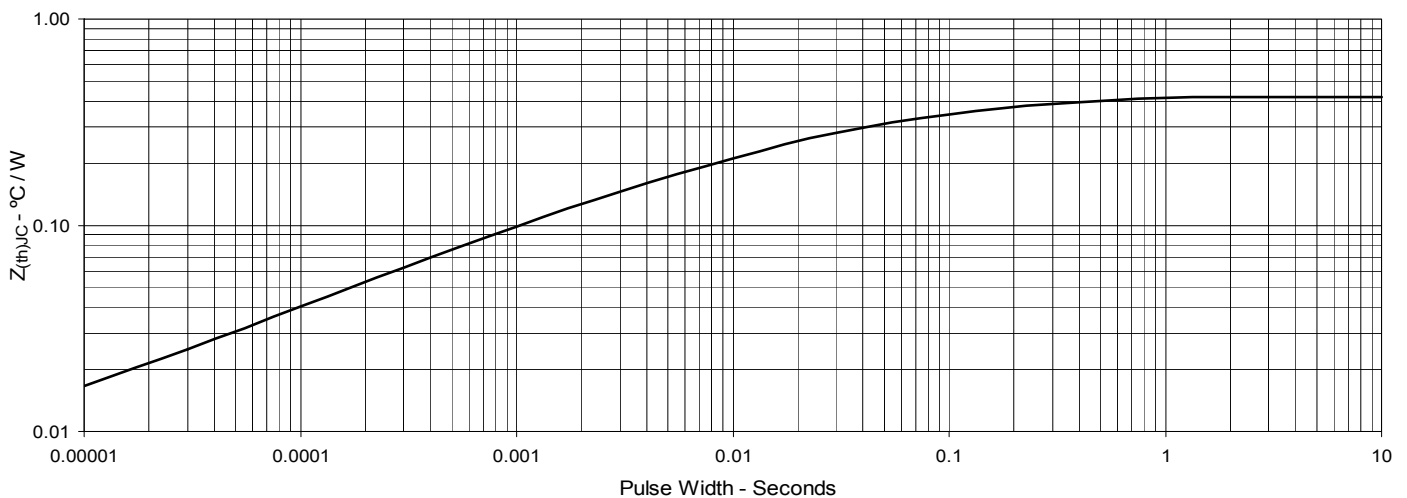
**Fig. 9. Capacitance**



**Fig. 10. Reverse-Bias Safe Operating Area**

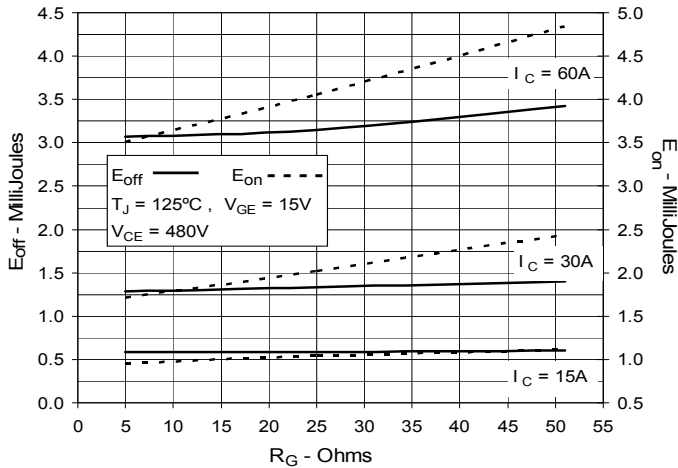


**Fig. 11. Maximum Transient Thermal Impedance**

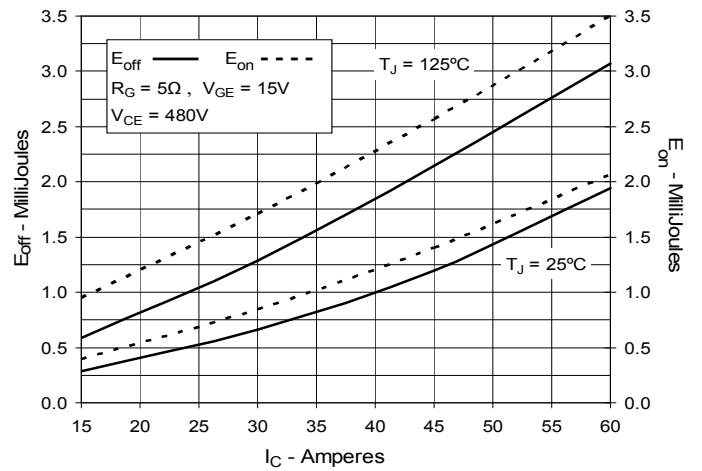


IXYS reserves the right to change limits, test conditions and dimensions.

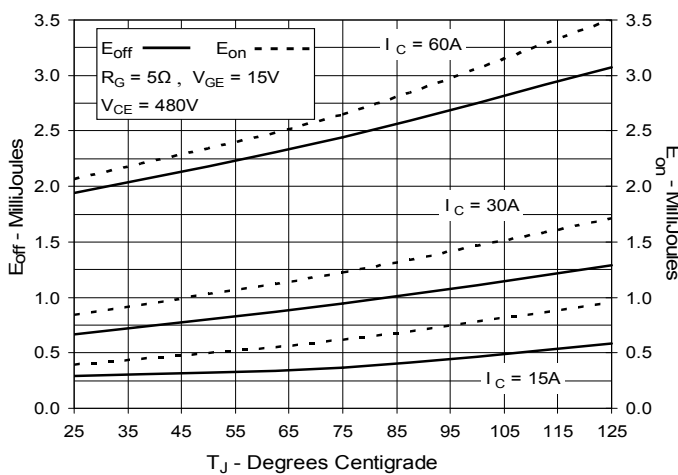
**Fig. 12. Inductive Switching Energy Loss vs. Gate Resistance**



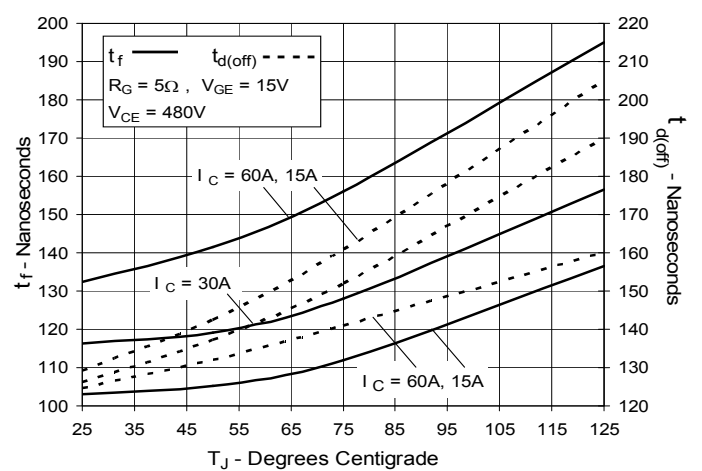
**Fig. 13. Inductive Switching Energy Loss vs. Collector Current**



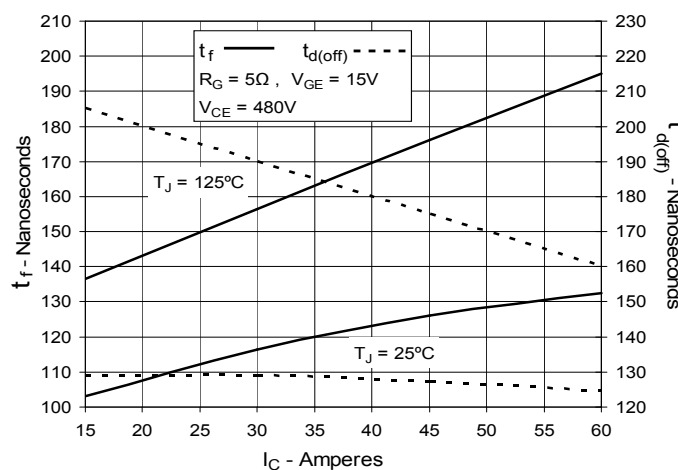
**Fig. 14. Inductive Switching Energy Loss vs. Junction Temperature**



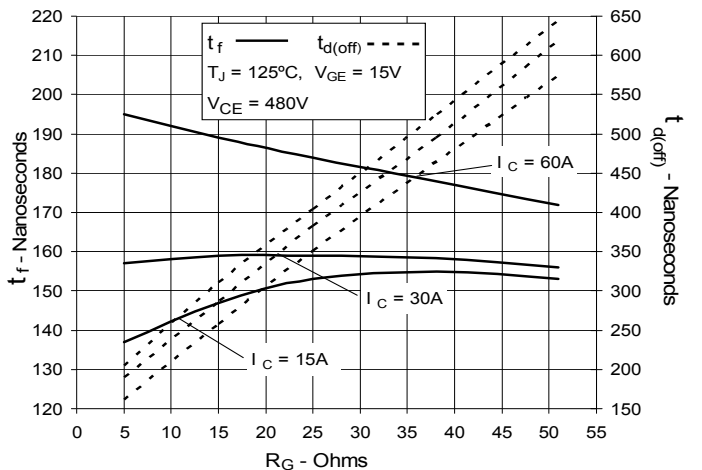
**Fig. 15. Inductive Turn-off Switching Times vs. Junction Temperature**



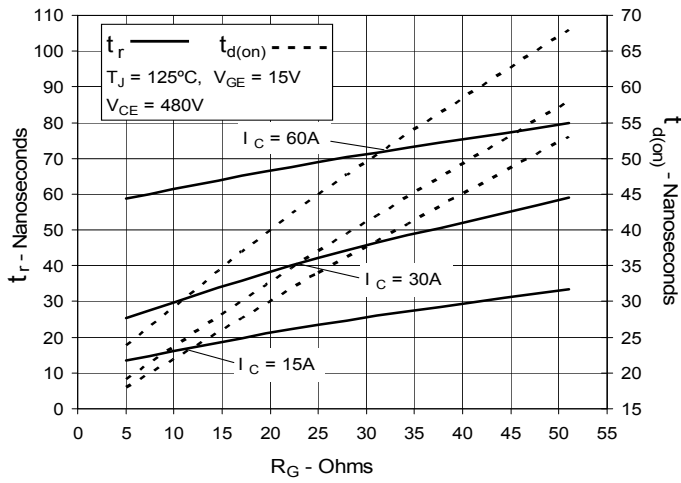
**Fig. 16. Inductive Turn-off Switching Times vs. Collector Current**



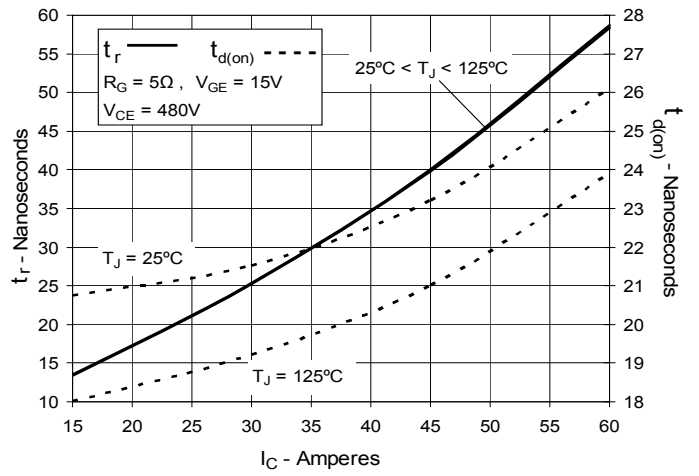
**Fig. 17. Inductive Turn-off Switching Times vs. Gate Resistance**



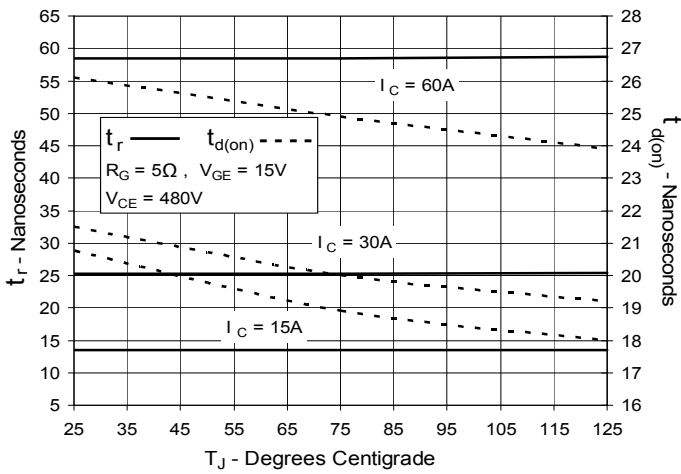
**Fig. 18. Inductive Turn-on  
Switching Times vs. Gate Resistance**



**Fig. 19. Inductive Turn-on  
Switching Times vs. Collector Current**



**Fig. 20. Inductive Turn-on  
Switching Times vs. Junction Temperature**



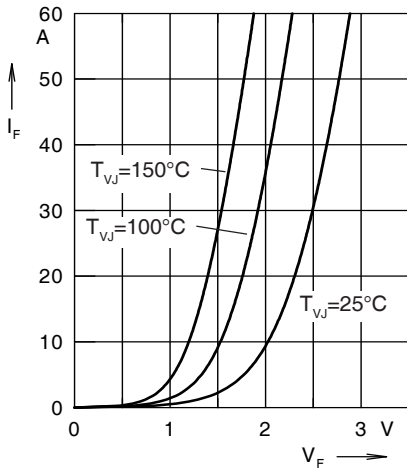


Fig. 21. Forward current  $I_F$  versus  $V_F$

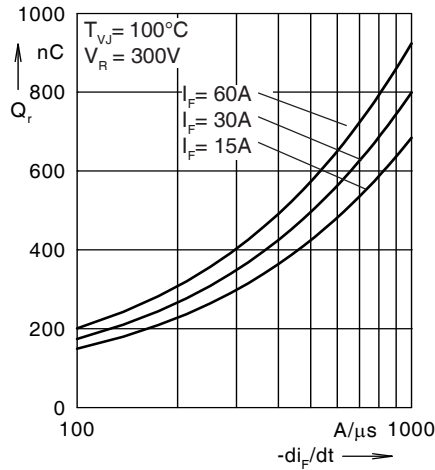


Fig. 22. Reverse recovery charge  $Q_r$  versus  $-di_F/dt$

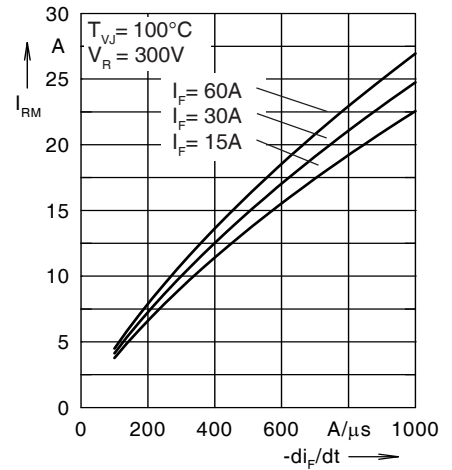


Fig. 23. Peak reverse current  $I_{RM}$  versus  $-di_F/dt$

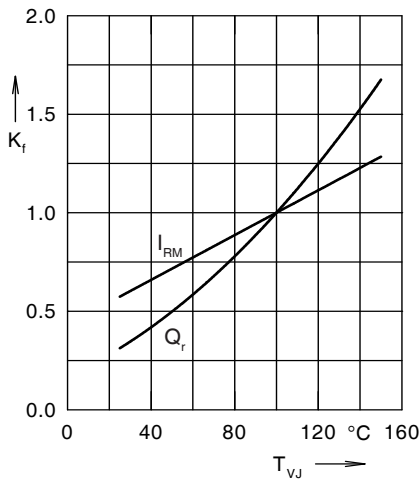


Fig. 24. Dynamic parameters  $Q_r$ ,  $I_{RM}$  versus  $T_{VJ}$

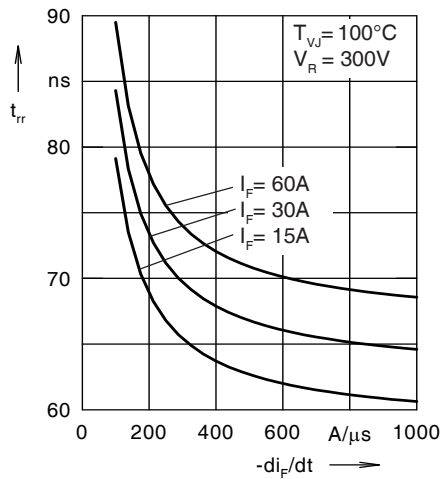


Fig. 25. Recovery time  $t_{rr}$  versus  $-di_F/dt$

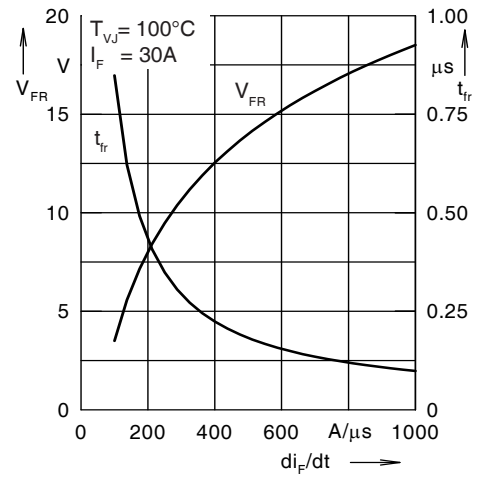


Fig. 26. Peak forward voltage  $V_{FR}$  and  $t_{fr}$  versus  $di_F/dt$

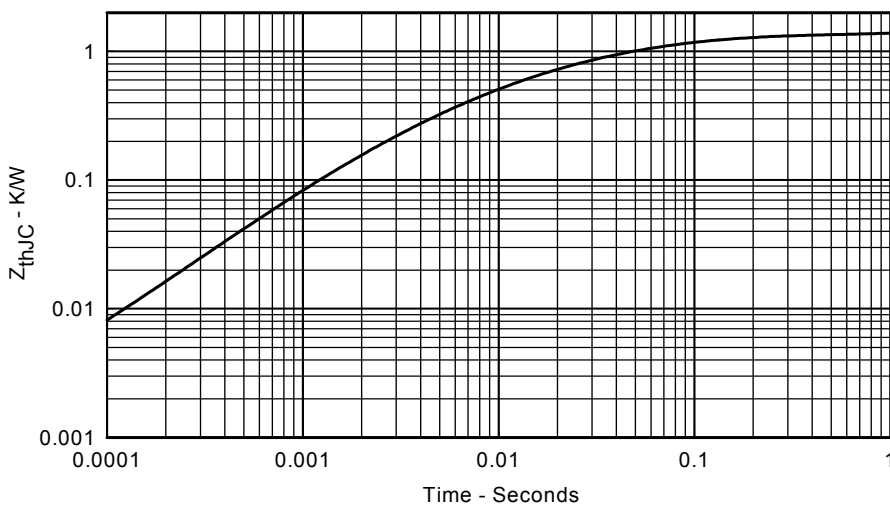


Fig. 27. Transient thermal resistance junction to case