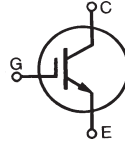


## GenX3™ 600V IGBT

**IXGA48N60C3**  
**IXGH48N60C3**  
**IXGP48N60C3**

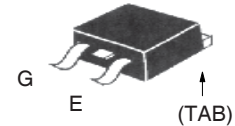
High Speed PT IGBTs for  
 40-100kHz switching



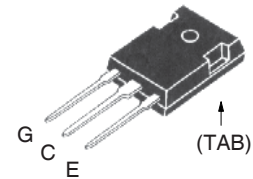
**V<sub>CES</sub> = 600V**  
**I<sub>C110</sub> = 48A**  
**V<sub>CE(sat)</sub> ≤ 2.5V**  
**t<sub>fi(typ)</sub> = 38ns**

Symbol	Test Conditions	Maximum Ratings	
V <sub>CES</sub>	T <sub>C</sub> = 25°C to 150°C	600	V
V <sub>CGR</sub>	T <sub>J</sub> = 25°C to 150°C, R <sub>GE</sub> = 1MΩ	600	V
V <sub>GES</sub>	Continuous	± 20	V
V <sub>GEM</sub>	Transient	± 30	V
I <sub>C25</sub>	T <sub>C</sub> = 25°C ( Limited by Leads)	75	A
I <sub>C110</sub>	T <sub>C</sub> = 110°C	48	A
I <sub>CM</sub>	T <sub>C</sub> = 25°C, 1ms	250	A
I <sub>A</sub>	T <sub>C</sub> = 25°C	30	A
E <sub>AS</sub>	T <sub>C</sub> = 25°C	300	mJ
<b>SSOA</b> <b>(RBSOA)</b>	V <sub>GE</sub> = 15V, T <sub>VJ</sub> = 125°C, R <sub>G</sub> = 3Ω Clamped Inductive Load @ ≤ 600V	I <sub>CM</sub> = 100	A
P <sub>C</sub>	T <sub>C</sub> = 25°C	300	W
T <sub>J</sub>		-55 ... +150	°C
T <sub>JM</sub>		150	°C
T <sub>stg</sub>		-55 ... +150	°C
T <sub>L</sub>	1.6mm (0.062 in.) from Case for 10s	300	°C
T <sub>SOLD</sub>	Plastic Body for 10 Seconds	260	°C
M <sub>d</sub>	Mounting Torque (TO-247&TO-220)	1.13/10	Nm/lb.in.
<b>Weight</b>	TO-247	6.0	g
	TO-220	3.0	g
	TO-263	2.5	g

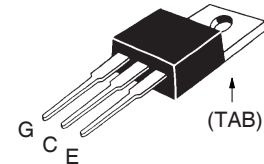
TO-263 (IXGA)



TO-247 (IXGH)



TO-220 (IXGP)



G = Gate      C = Collector  
 E = Emitter    TAB = Collector

### Features

- Optimized for Low Switching Losses
- Square RBSOA
- Avalanche Rated
- Fast Switching
- International Standard Packages

### Advantages

- High Power Density
- Low Gate Drive Requirement

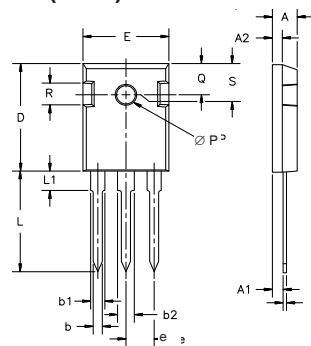
### Applications

- High Frequency Power Inverters
- UPS
- Motor Drives
- SMPS
- PFC Circuits
- Battery Chargers
- Welding Machines
- Lamp Ballasts

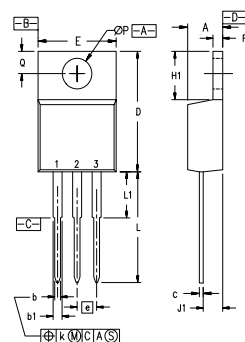
Symbol	Test Conditions	Characteristic Values		
		Min.	Typ.	Max.
BV <sub>CES</sub>	I <sub>C</sub> = 250μA, V <sub>GE</sub> = 0V	600		V
V <sub>GE(th)</sub>	I <sub>C</sub> = 250μA, V <sub>CE</sub> = V <sub>GE</sub>	3.0		5.5 V
I <sub>CES</sub>	V <sub>CE</sub> = V <sub>CES</sub>			25 μA
	V <sub>GE</sub> = 0V      T <sub>J</sub> = 125°C			250 μA
I <sub>GES</sub>	V <sub>CE</sub> = 0V, V <sub>GE</sub> = ± 20V			±100 nA
V <sub>CE(sat)</sub>	I <sub>C</sub> = 30A, V <sub>GE</sub> = 15V, Note 1 T <sub>J</sub> = 125°C		2.3	2.5 V
			1.8	V

Symbol	Test Conditions	Characteristic Values		
		Min.	Typ.	Max.
$g_{fs}$	$I_C = 30A, V_{CE} = 10V$ , Note 1	20	30	S
$C_{ies}$	$V_{CE} = 25V, V_{GE} = 0V, f = 1MHz$		1960	pF
$C_{oes}$			207	pF
$C_{res}$			66	pF
$Q_g$	$I_C = 30A, V_{GE} = 15V, V_{CE} = 0.5 \cdot V_{CES}$		77	nC
$Q_{ge}$			16	nC
$Q_{gc}$			32	nC
$t_{d(on)}$	<b>Inductive Load, <math>T_J = 25^\circ C</math></b> $I_C = 30A, V_{GE} = 15V$ $V_{CE} = 400V, R_G = 3\Omega$		19	ns
$t_{ri}$			26	ns
$E_{on}$			0.41	mJ
$t_{d(off)}$			60	100 ns
$t_{fi}$			38	ns
$E_{off}$			0.23	0.42 mJ
$t_{d(on)}$	<b>Inductive Load, <math>T_J = 125^\circ C</math></b> $I_C = 30A, V_{GE} = 15V$ $V_{CE} = 400V, R_G = 3\Omega$		19	ns
$t_{ri}$			26	ns
$E_{on}$			0.65	mJ
$t_{d(off)}$			92	ns
$t_{fi}$			95	ns
$E_{off}$			0.57	mJ
$R_{thJC}$			0.42	$^\circ C/W$
$R_{thCS}$	(TO-247)	0.21		$^\circ C/W$
	(TO-220)	0.50		$^\circ C/W$

Note 1: Pulse Test,  $t \leq 300\mu s$ ; Duty Cycle,  $d \leq 2\%$ .

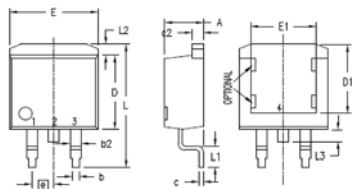
**TO-247 (IXGH) Outline**


Dim.	Millimeter		Inches	
	Min.	Max.	Min.	Max.
A	4.7	5.3	.185	.209
A <sub>1</sub>	2.2	2.54	.087	.102
A <sub>2</sub>	2.2	2.6	.059	.098
b	1.0	1.4	.040	.055
b <sub>1</sub>	1.65	2.13	.065	.084
b <sub>2</sub>	2.87	3.12	.113	.123
C	.4	.8	.016	.031
D	20.80	21.46	.819	.845
E	15.75	16.26	.610	.640
e	5.20	5.72	0.205	0.225
L	19.81	20.32	.780	.800
L1		4.50		.177
∅P	3.55	3.65	.140	.144
Q	5.89	6.40	0.232	0.252
R	4.32	5.49	.170	.216
S	6.15	BSC	.242	BSC

**TO-220 (IXGP) Outline**


Pins: 1 - Gate 2 - Drain  
3 - Source 4 - Drain

SYM	INCHES		MILLIMETERS	
	MIN	MAX	MIN	MAX
A	.170	.190	4.32	4.83
b	.025	.040	0.64	1.02
b1	.045	.065	1.15	1.65
c	.014	.022	0.35	0.56
D	.580	.630	14.73	16.00
E	.390	.420	9.91	10.66
e	.100 BSC		2.54 BSC	
F	.045	.055	1.14	1.40
H1	.230	.270	5.85	6.85
J1	.090	.110	2.29	2.79
k	0	.015	0	0.38
L	.500	.550	12.70	13.97
L1	.110	.230	2.79	5.84
∅P	.139	.161	3.53	4.08
Q	.100	.125	2.54	3.18

**TO-263 (IXGA) Outline**


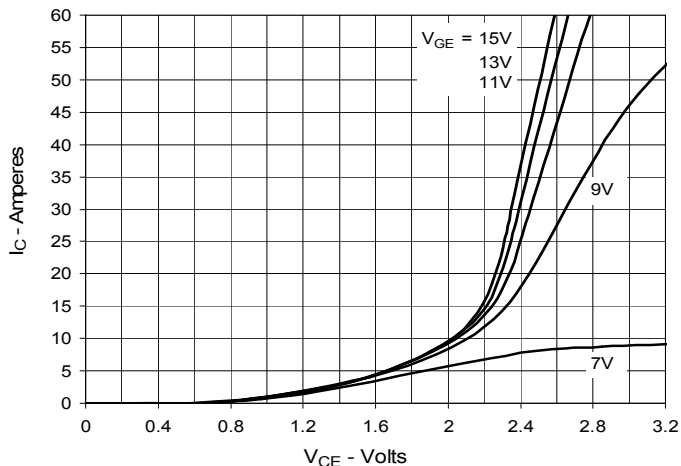
1. GATE (COLLECTOR)
2. DRAIN (COLLECTOR)
3. SOURCE (EMITTER)
4. DRAIN (COLLECTOR) BOTTOM SIDE

SYM	INCHES		MILLIMETERS	
	MIN	MAX	MIN	MAX
A	.160	.190	4.06	4.83
A1	.080	.110	2.03	2.79
b	.020	.039	0.51	0.99
b2	.045	.055	1.14	1.40
c	.016	.029	0.40	0.74
c2	.045	.055	1.14	1.40
D	.340	.380	8.64	9.65
D1	.315	.350	8.00	8.89
E	.380	.410	9.65	10.41
E1	.245	.320	6.22	8.13
e	.100 BSC		2.54 BSC	
L	.575	.625	14.61	15.88
L1	.090	.110	2.29	2.79
L2	.040	.055	1.02	1.40
L3	.050	.070	1.27	1.78
L4	0	.005	0	0.13

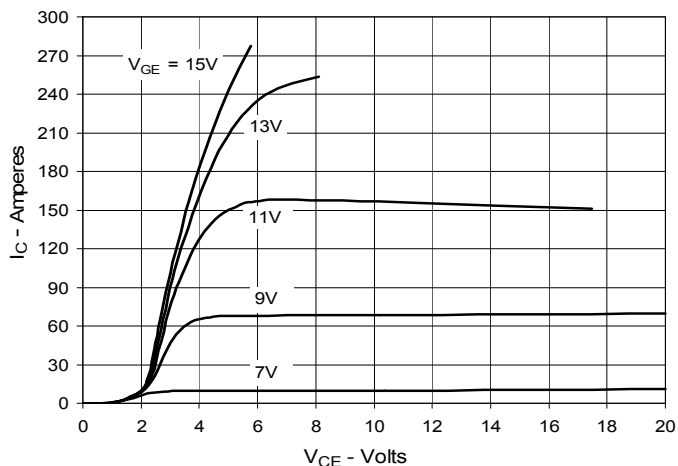
IXYS reserves the right to change limits, test conditions and dimensions.

IXYS MOSFETs and IGBTs are covered 4,835,592 4,931,844 5,049,961 5,237,481 6,162,665 6,404,065 B1 6,683,344 6,727,585 7,005,734 B2 7,157,338B2  
by one or more of the following U.S. patents: 4,850,072 5,017,508 5,063,307 5,381,025 6,259,123 B1 6,534,343 6,710,405 B2 6,759,692 7,063,975 B2  
4,881,106 5,034,796 5,187,117 5,486,715 6,306,728 B1 6,583,505 6,710,463 6,771,478 B2 7,071,537

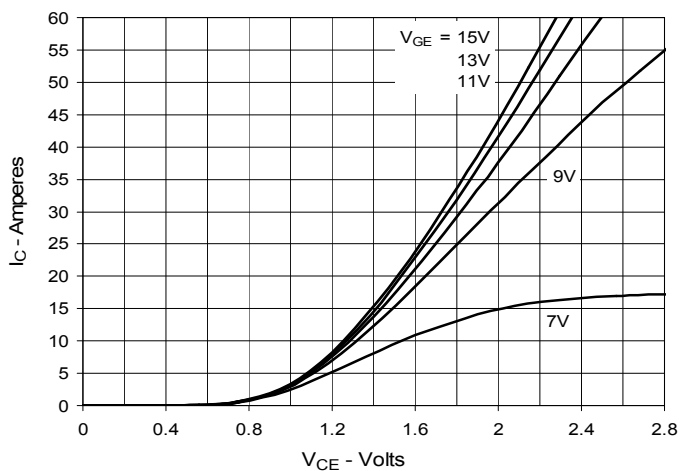
**Fig. 1. Output Characteristics @ 25°C**



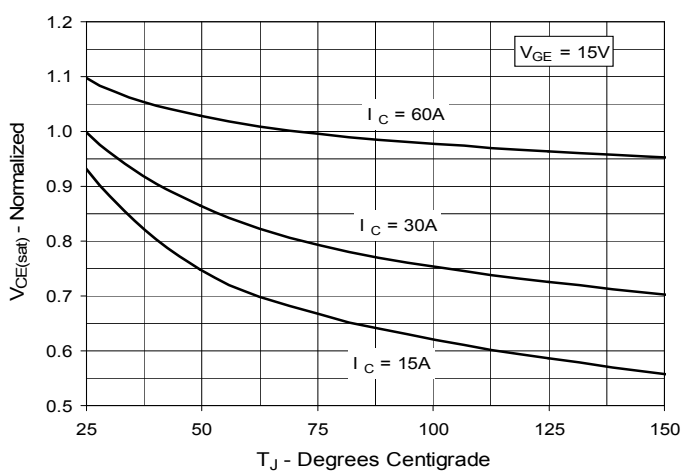
**Fig. 2. Extended Output Characteristics @ 25°C**



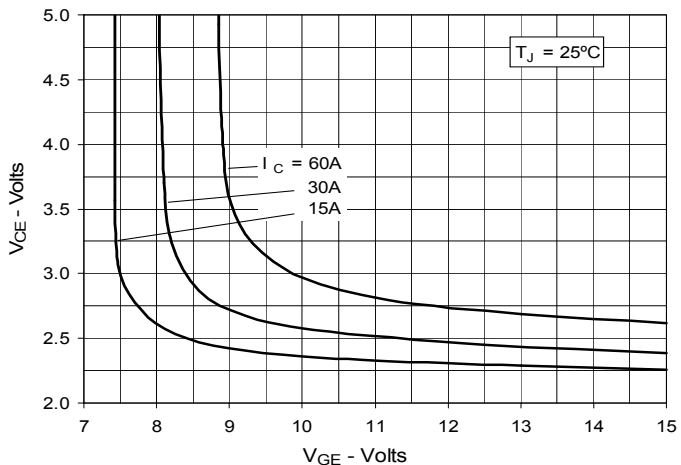
**Fig. 3. Output Characteristics @ 125°C**



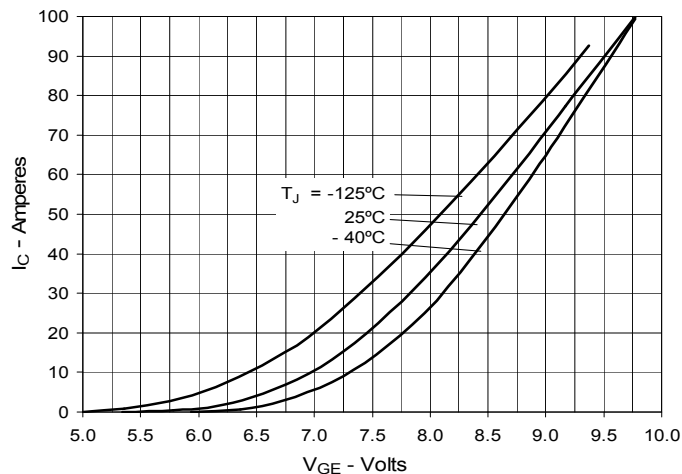
**Fig. 4. Dependence of VCE(sat) on Junction Temperature**



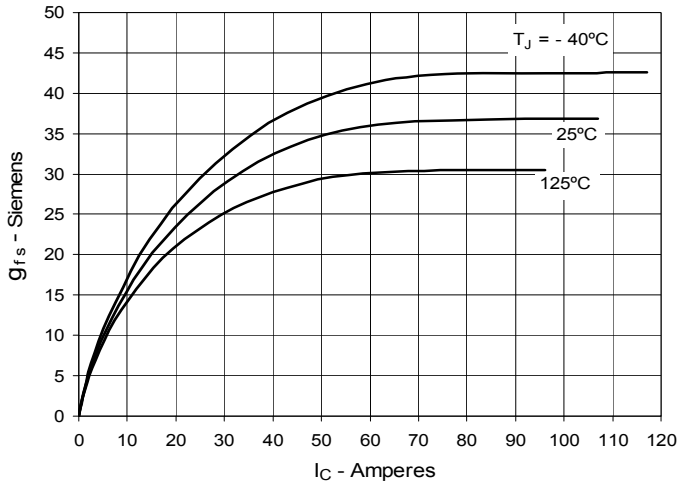
**Fig. 5. Collector-to-Emitter Voltage vs. Gate-to-Emitter Voltage**



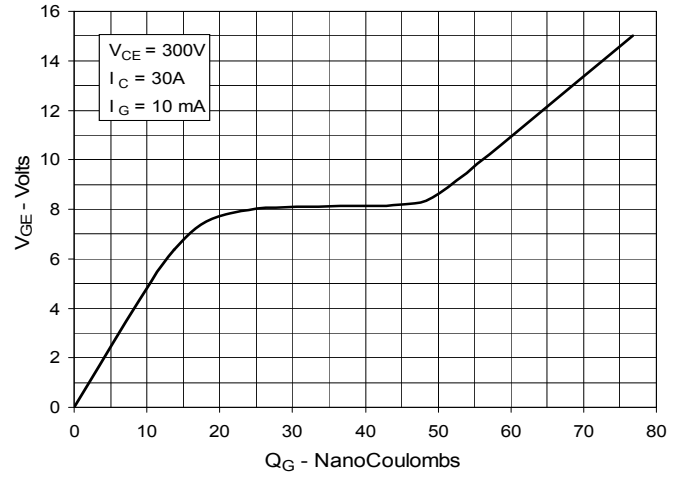
**Fig. 6. Input Admittance**



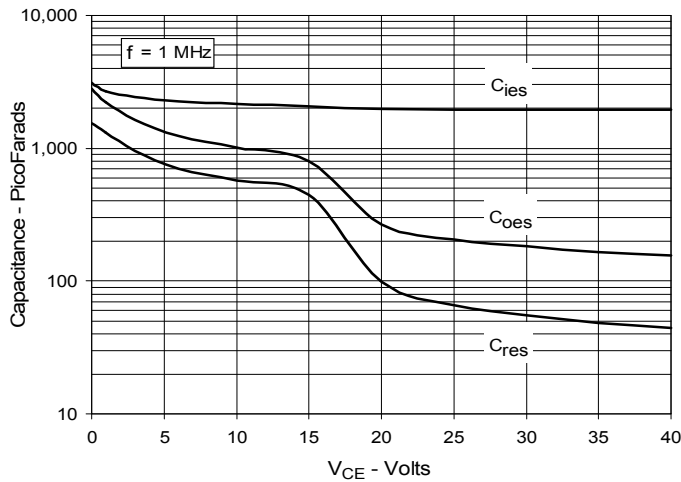
**Fig. 7. Transconductance**



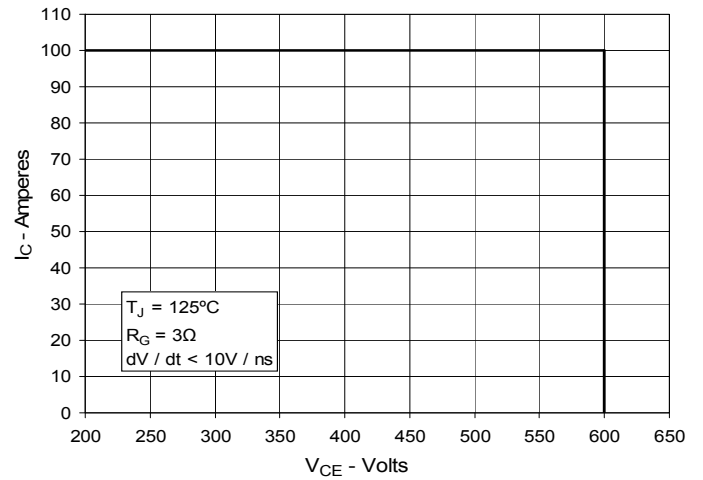
**Fig. 8. Gate Charge**



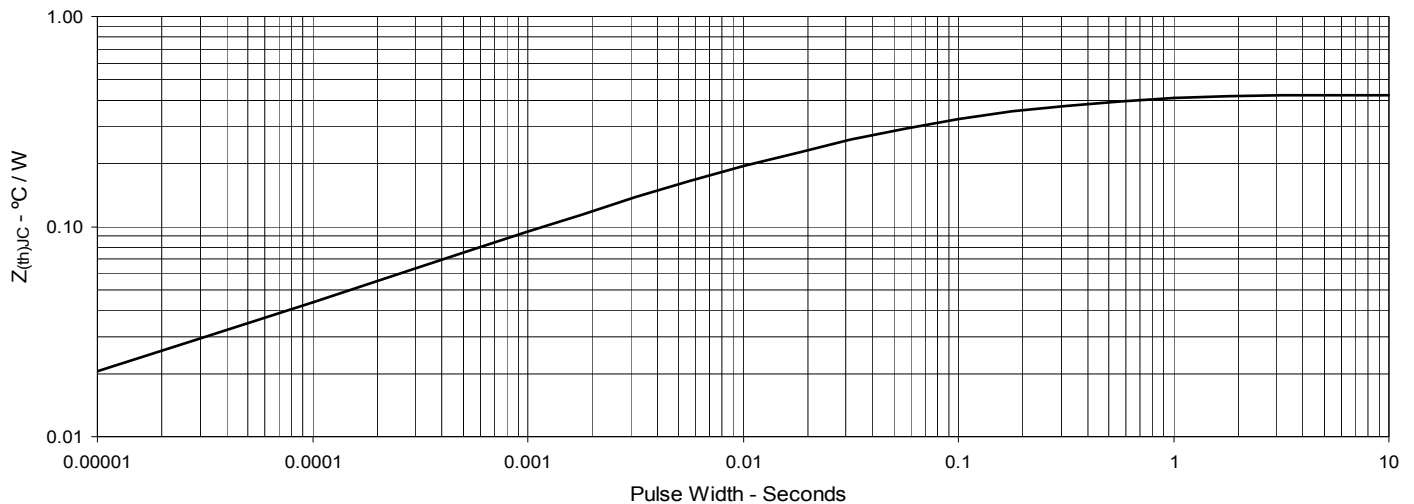
**Fig. 9. Capacitance**



**Fig. 10. Reverse-Bias Safe Operating Area**

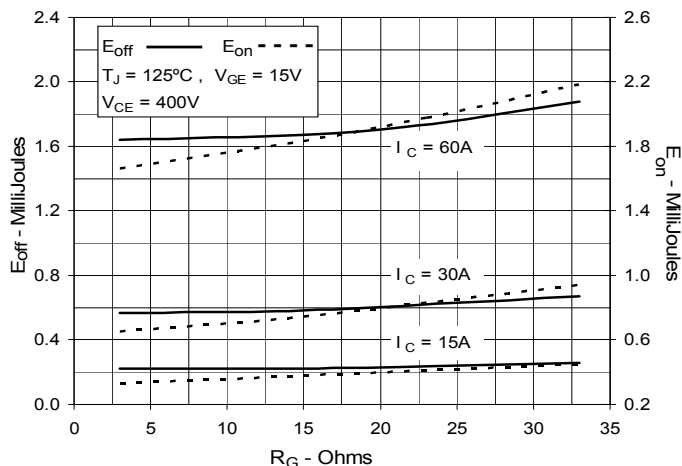


**Fig. 11. Maximum Transient Thermal Impedance**

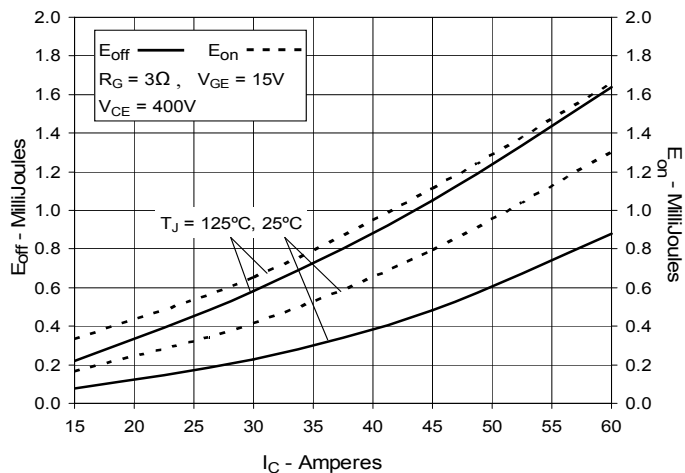


IXYS reserves the right to change limits, test conditions and dimensions.

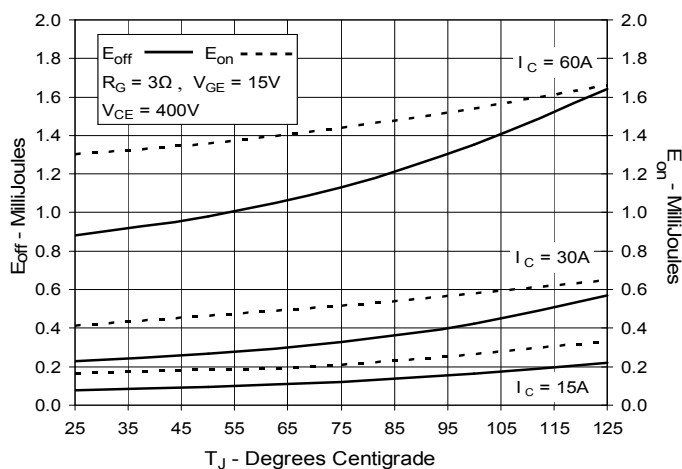
**Fig. 12. Inductive Switching Energy Loss vs. Gate Resistance**



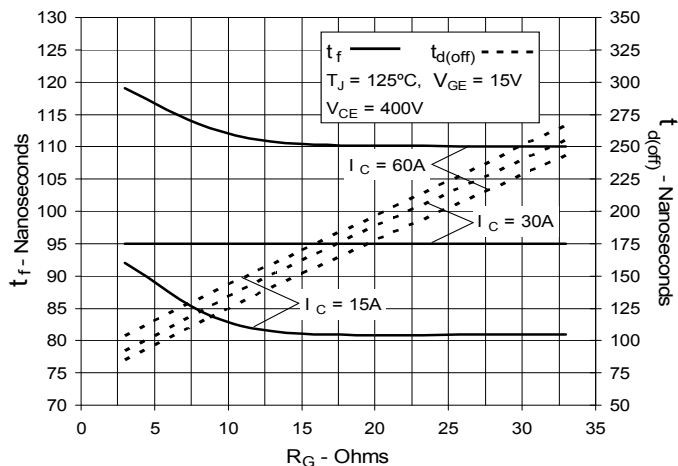
**Fig. 13. Inductive Switching Energy Loss vs. Collector Current**



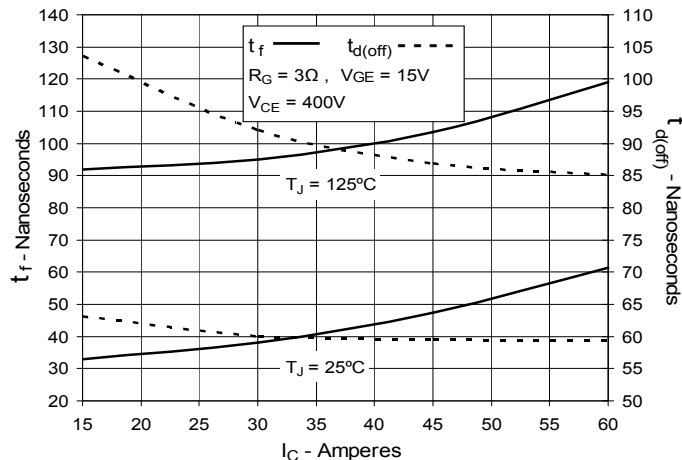
**Fig. 14. Inductive Switching Energy Loss vs. Junction Temperature**



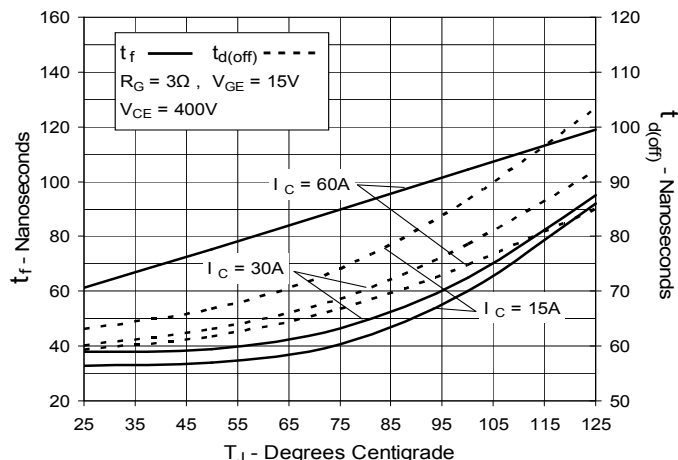
**Fig. 15. Inductive Turn-off Switching Times vs. Gate Resistance**



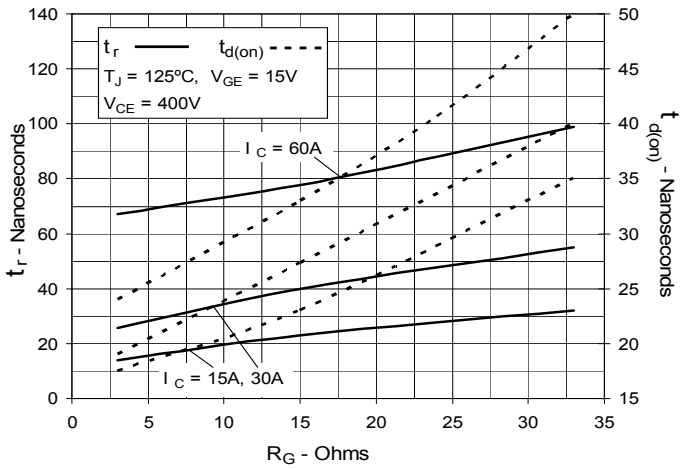
**Fig. 16. Inductive Turn-off Switching Times vs. Collector Current**



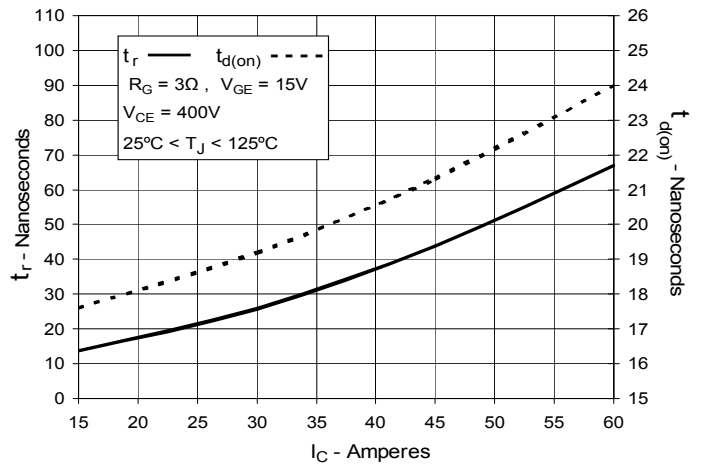
**Fig. 17. Inductive Turn-off Switching Times vs. Junction Temperature**



**Fig. 18. Inductive Turn-on  
Switching Times vs. Gate Resistance**



**Fig. 19. Inductive Turn-on  
Switching Times vs. Collector Current**



**Fig. 20. Inductive Turn-on  
Switching Times vs. Junction Temperature**

