

# Ultra-Low $V_{CE(sat)}$ IGBT

**IXGH 60N60**  
**IXGK 60N60**  
**IXGT 60N60**

$V_{CES} = 600\text{ V}$   
 $I_{C25} = 75\text{ A}$   
 $V_{CE(sat)} = 1.7\text{ V}$

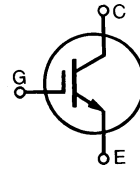

Symbol	Test Conditions	Maximum Ratings	
$V_{CES}$	$T_J = 25^\circ\text{C}$ to $150^\circ\text{C}$	600	V
$V_{CGR}$	$T_J = 25^\circ\text{C}$ to $150^\circ\text{C}$ ; $R_{GE} = 1\text{ M}\Omega$	600	V
$V_{GES}$	Continuous	$\pm 20$	V
$V_{GEM}$	Transient	$\pm 30$	V
$I_{C25}$	$T_C = 25^\circ\text{C}$ , limited by leads	75	A
$I_{C90}$	$T_C = 90^\circ\text{C}$	60	A
$I_{CM}$	$T_C = 25^\circ\text{C}$ , 1 ms	200	A
<b>SSOA (RBSOA)</b>	$V_{GE} = 15\text{ V}$ , $T_{VJ} = 125^\circ\text{C}$ , $R_G = 10\ \Omega$ Clamped inductive load, $L = 30\ \mu\text{H}$	$I_{CM} = 100$ @ $0.8 V_{CES}$	A
$P_C$	$T_C = 25^\circ\text{C}$	300	W
$T_J$		-55 ... +150	$^\circ\text{C}$
$T_{JM}$		150	$^\circ\text{C}$
$T_{stg}$		-55 ... +150	$^\circ\text{C}$
$M_d$	Mounting torque (M3)	1.13/10	Nm/lb.in.
	Maximum lead temperature for soldering 1.6 mm (0.062 in.) from case for 10 s	300	$^\circ\text{C}$
<b>Weight</b>	TO-247	6	g
	TO-264	10	g
	TO-268	4	g

TO-247 AD (IXGH)

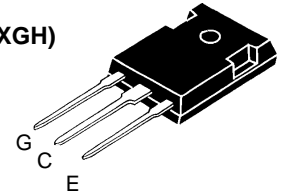

TO-268 (IXGT)

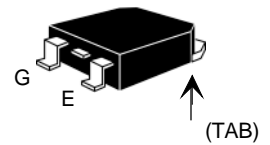

TO-264 (IXGK)

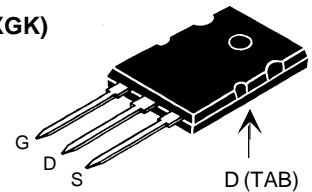

G = Gate, C = Collector,  
E = Emitter, TAB = Collector

### Features

- International standard package JEDEC TO-247 AD, TO-264, TO-268
- New generation HDMOS™ process
- Low  $V_{CE(sat)}$  for minimum on-state conduction losses
- High current handling capability
- MOS Gate turn-on drive simplicity

### Applications

- AC motor speed control
- DC servo and robot drives
- DC choppers
- Uninterruptible power supplies (UPS)
- Switch-mode and resonant-mode power supplies

### Advantages

- Easy to mount with 1 screw (isolated mounting screw hole)
- Low losses, high efficiency
- High power density
- High power, surface mount package

Symbol	Test Conditions	Characteristic Values ( $T_J = 25^\circ\text{C}$ , unless otherwise specified)		
		min.	typ.	max.
$BV_{CES}$	$I_C = 250\ \mu\text{A}$ , $V_{GE} = 0\text{ V}$	600		V
$V_{GE(th)}$	$I_C = 250\ \mu\text{A}$ , $V_{CE} = V_{GE}$	2.5		V
$I_{CES}$	$V_{CE} = 0.8 \cdot V_{CES}$ , $V_{GE} = 0\text{ V}$ $T_J = 25^\circ\text{C}$ $T_J = 125^\circ\text{C}$			200 $\mu\text{A}$ 1 mA
$I_{GES}$	$V_{CE} = 0\text{ V}$ , $V_{GE} = \pm 20\text{ V}$			$\pm 100\text{ nA}$
$V_{CE(sat)}$	$I_C = I_{C90}$ , $V_{GE} = 15\text{ V}$			1.7 V

Symbol	Test Conditions	Characteristic Values ( $T_J = 25^\circ\text{C}$ , unless otherwise specified)			
		min.	typ.	max.	
$g_{fs}$	$I_C = I_{C90}, V_{CE} = 10\text{ V}$ , Pulse test, $t \leq 300\ \mu\text{s}$ , duty cycle $\leq 2\%$	30	55	S	
$C_{ies}$	$V_{CE} = 25\text{ V}, V_{GE} = 0\text{ V}, f = 1\text{ MHz}$		3700	pF	
$C_{oes}$			290	pF	
$C_{res}$			86	pF	
$Q_g$	$I_C = I_{C90}, V_{GE} = 15\text{ V}, V_{CE} = 0.5 V_{CES}$		130	nC	
$Q_{ge}$			30	nC	
$Q_{gc}$			45	nC	
$t_{d(on)}$	<b>Inductive load, <math>T_J = 25^\circ\text{C}</math></b> $I_C = I_{C90}, V_{GE} = 15\text{ V}, L = 100\ \mu\text{H}$ , $V_{CE} = 0.8 V_{CES}, R_G = R_{off} = 2.7\ \Omega$ Remarks: Switching times may increase for $V_{CE}$ (Clamp) $> 0.8 \cdot V_{CES}$ , higher $T_J$ or increased $R_G$		50	ns	
$t_{ri}$			25	ns	
$t_{d(off)}$			300	600	ns
$t_{fi}$			360	570	ns
$E_{off}$			8	15	mJ
$t_{d(on)}$	<b>Inductive load, <math>T_J = 125^\circ\text{C}</math></b> $I_C = I_{C90}, V_{GE} = 15\text{ V}, L = 100\ \mu\text{H}$ $V_{CE} = 0.8 V_{CES}, R_G = R_{off} = 2.7\ \Omega$ Remarks: Switching times may increase for $V_{CE}$ (Clamp) $> 0.8 \cdot V_{CES}$ , higher $T_J$ or increased $R_G$		50	ns	
$t_{ri}$			25	ns	
$E_{on}$			3	mJ	
$t_{d(off)}$			650	ns	
$t_{fi}$			550	ns	
$E_{off}$		17	mJ		
$R_{thJC}$			0.42	K/W	
$R_{thCK}$	(IXGH)	0.25		K/W	
	(IXGK)	0.15		K/W	

### TO-247 AD (IXFH) Outline

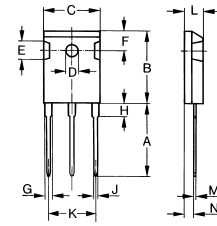

Dim.	Millimeter		Inches	
	Min.	Max.	Min.	Max.
A	19.81	20.32	0.780	0.800
B	20.80	21.46	0.819	0.845
C	15.75	16.26	0.610	0.640
D	3.55	3.65	0.140	0.144
E	4.32	5.49	0.170	0.216
F	5.4	6.2	0.212	0.244
G	1.65	2.13	0.065	0.084
H	-	4.5	-	0.177
J	1.0	1.4	0.040	0.055
K	10.8	11.0	0.426	0.433
L	4.7	5.3	0.185	0.209
M	0.4	0.8	0.016	0.031
N	1.5	2.49	0.087	0.102

### TO-264 AA (IXFK) Outline

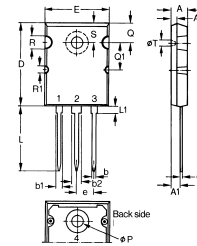

Dim.	Millimeter		Inches	
	Min.	Max.	Min.	Max.
A	4.82	5.13	.190	.202
A1	2.54	2.89	.100	.114
A2	2.00	2.10	.079	.083
b	1.12	1.42	.044	.056
b1	2.39	2.69	.094	.106
b2	2.90	3.09	.114	.122
c	0.53	0.83	.021	.033
D	25.91	26.16	1.020	1.030
E	19.81	19.96	.780	.786
e	5.46 BSC		.215 BSC	
J	0.00	0.25	.000	.010
K	0.00	0.25	.000	.010
L	20.32	20.83	.800	.820
L1	2.29	2.59	.090	.102
P	3.17	3.66	.125	.144
Q	6.07	6.27	.239	.247
Q1	8.38	8.69	.330	.342
R	3.81	4.32	.150	.170
R1	1.78	2.29	.070	.090
S	6.04	6.30	.238	.248
T	1.57	1.83	.062	.072

### TO-268AA (IXFT) (D<sup>3</sup> PAK)

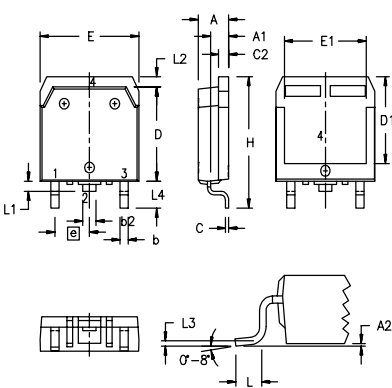

Dim.	Millimeter		Inches	
	Min.	Max.	Min.	Max.
A	4.9	5.1	.193	.201
A <sub>1</sub>	2.7	2.9	.106	.114
A <sub>2</sub>	.02	.25	.001	.010
b	1.15	1.45	.045	.057
b <sub>2</sub>	1.9	2.1	.75	.83
C	.4	.65	.016	.026
D	13.80	14.00	.543	.551
E	15.85	16.05	.624	.632
E <sub>1</sub>	13.3	13.6	.524	.535
e	5.45 BSC		.215 BSC	
H	18.70	19.10	.736	.752
L	2.40	2.70	.094	.106
L1	1.20	1.40	.047	.055
L2	1.00	1.15	.039	.045
L3	0.25 BSC		.010 BSC	
L4	3.80	4.10	.150	.161

### Min. Recommended Footprint

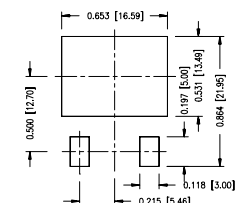

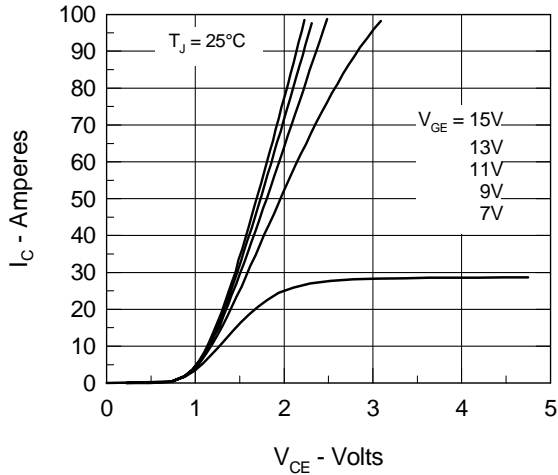

Fig. 1. Saturation Voltage Characteristics

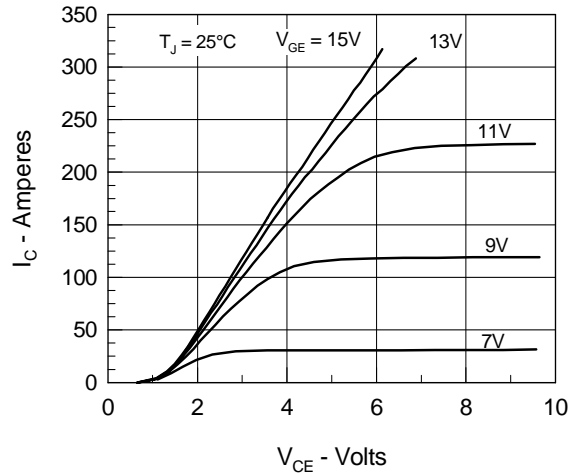

Fig. 2. Extended Output Characteristics

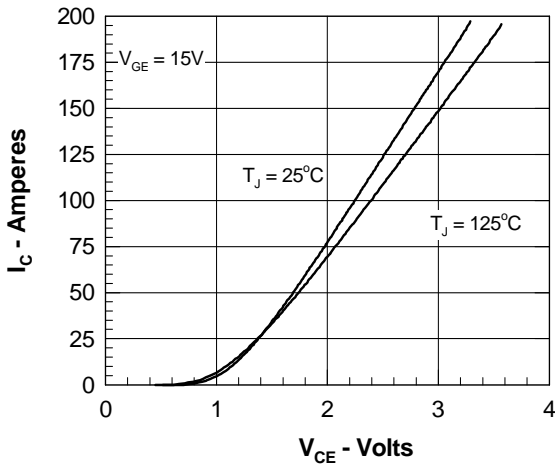

Fig. 3. Saturation Voltage Characteristics

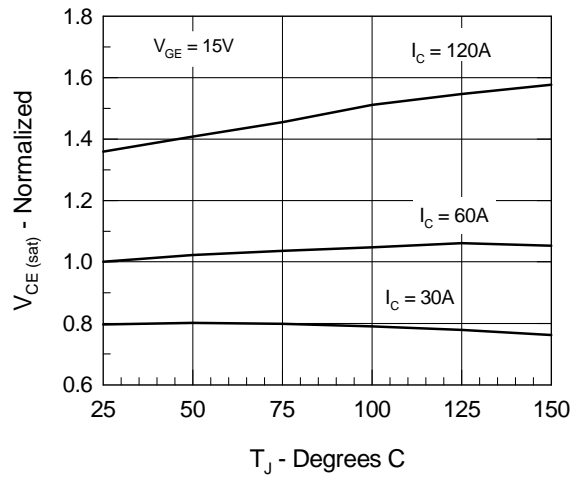

Fig. 4. Temperature Dependence of  $V_{CE(sat)}$

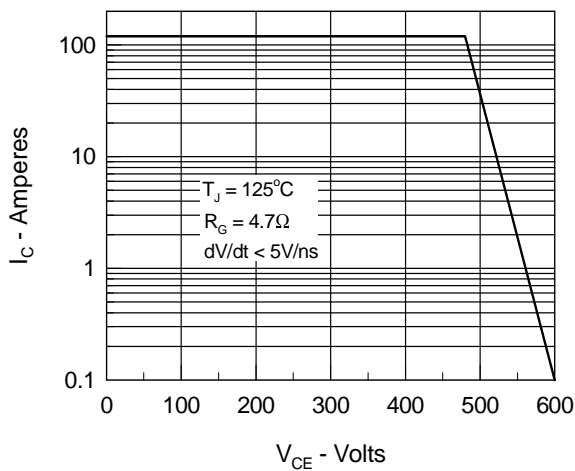

Fig. 5. Turn-off Safe Operating Area

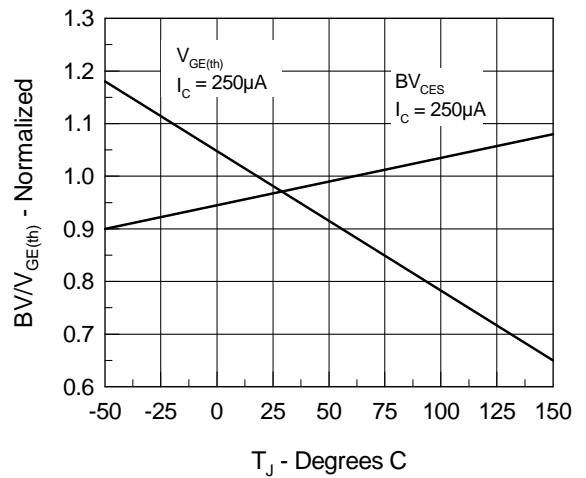

Fig. 6. Temperature Dependence of  $BV_{CES}$  &  $V_{GE(th)}$

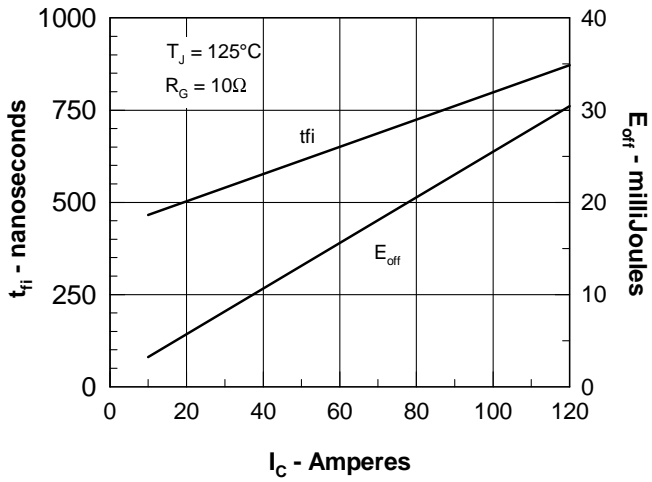

Fig. 7. Dependence of  $t_{fi}$  and  $E_{OFF}$  on  $I_c$ .

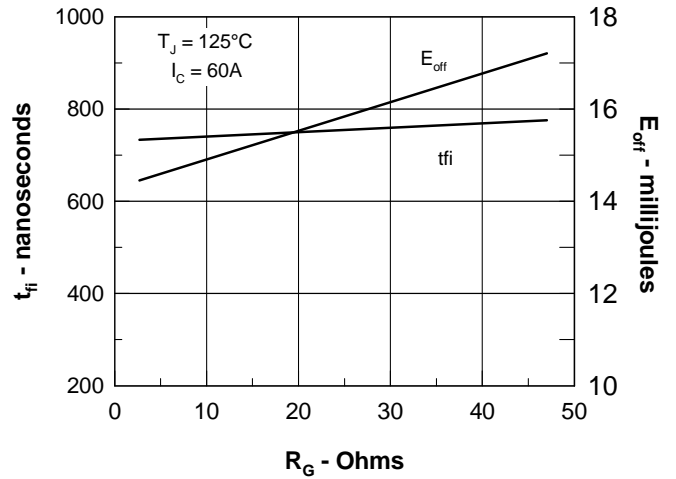

Fig. 8. Dependence of  $t_{fi}$  and  $E_{OFF}$  on  $R_G$ .

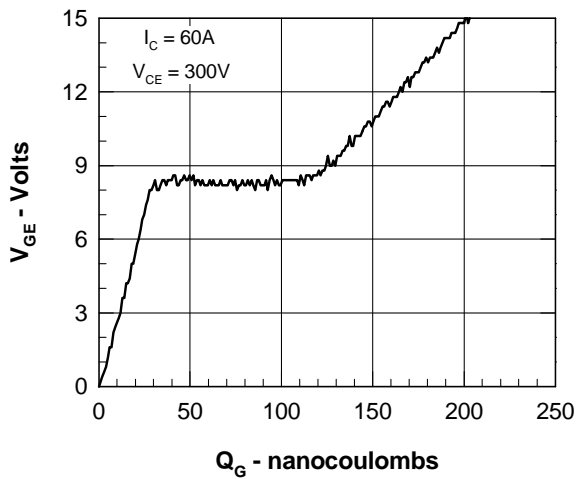

Fig. 9. Gate Charge

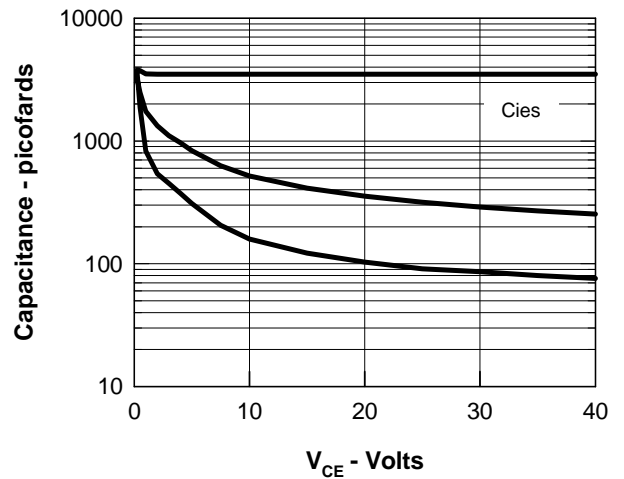

Fig. 10. Junction Capacitance Curves

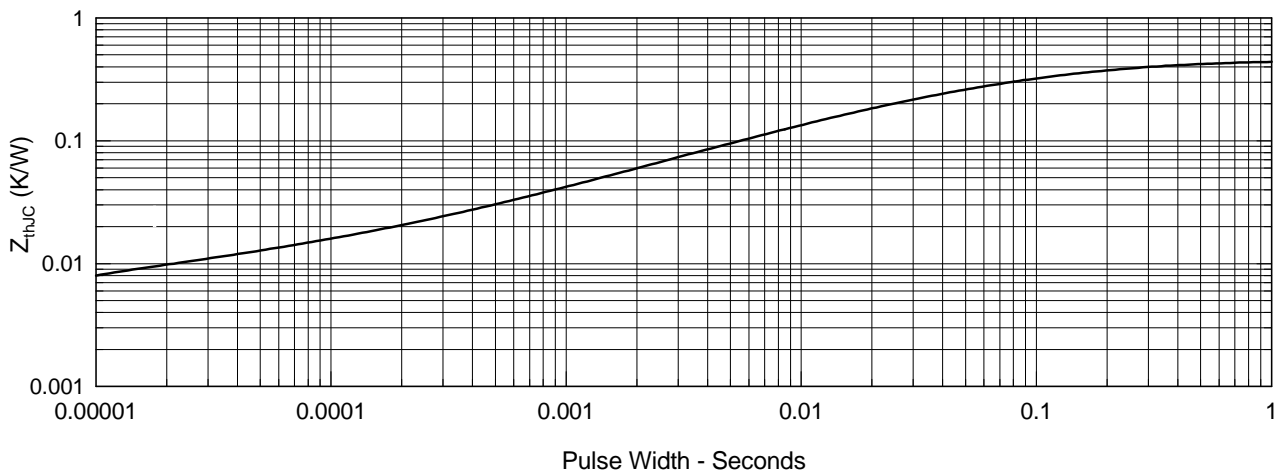

Fig. 11. Transient Thermal Resistance