

GenX3™ 600V IGBTs with Diode

IXGH60N60C3D1 IXGT60N60C3D1

$V_{CES} = 600V$
 $I_{C110} = 60A$
 $V_{CE(sat)} \leq 2.5V$
 $t_{fi} (typ) = 50ns$

High Speed PT IGBTs for
40-100kHz switching

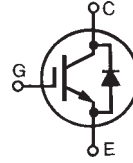

| Symbol | Test Conditions | Maximum Ratings | |
|-------------------------------|---|---|------------|
| V_{CES} | $T_J = 25^\circ C$ to $150^\circ C$ | 600 | V |
| V_{CGR} | $T_J = 25^\circ C$ to $150^\circ C$, $R_{GE} = 1M\Omega$ | 600 | V |
| V_{GES} | Continuous | ± 20 | V |
| V_{GEM} | Transient | ± 30 | V |
| I_{C25} | $T_C = 25^\circ C$, (Limited by Leads) | 75 | A |
| I_{C110} | $T_C = 110^\circ C$ | 60 | A |
| I_{F110} | $T_C = 110^\circ C$ | 26 | A |
| I_{CM} | $T_C = 25^\circ C$, 1ms | 300 | A |
| I_A | $T_C = 25^\circ C$ | 40 | A |
| E_{AS} | $T_C = 25^\circ C$ | 400 | mJ |
| SSOA (RBSOA) | $V_{GE} = 15V$, $T_{VJ} = 125^\circ C$, $R_G = 3\Omega$ Clamped Inductive Load | $I_{CM} = 125$ $V_{CE} \leq V_{CES}$ | A |
| P_C | $T_C = 25^\circ C$ | 380 | W |
| T_J | | -55 ... +150 | $^\circ C$ |
| T_{JM} | | 150 | $^\circ C$ |
| T_{stg} | | -55 ... +150 | $^\circ C$ |
| T_L | Maximum Lead Temperature for Soldering | 300 | $^\circ C$ |
| T_{SOLD} | 1.6 mm (0.062in.) from Case for 10s | 260 | $^\circ C$ |
| M_d | Mounting Torque (TO-247) | 1.13/10 | Nm/lb.in. |
| Weight | TO-268 | 4 | g |
| | TO-247 | 6 | g |

TO-247 (IXGH)

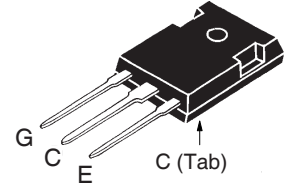

TO-268 (IXGT)

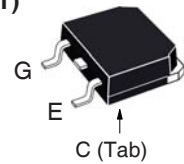

G = Gate C = Collector
 E = Emitter Tab = Collector

Features

- Optimized for Low Switching Losses
- Square RBSOA
- High Avalanche Capability
- Anti-Parallel Ultra Fast Diode
- International Standard Packages

Advantages

- High Power Density
- Low Gate Drive Requirement

Applications

- High Frequency Power Inverters
- UPS
- Motor Drives
- SMPS
- PFC Circuits
- Battery Chargers
- Welding Machines
- Lamp Ballasts

| Symbol | Test Conditions | Characteristic Values | | |
|---------------|---|-----------------------|------------|--------------------|
| | | Min. | Typ. | Max. |
| $V_{GE(th)}$ | $I_C = 250\mu A$, $V_{CE} = V_{GE}$ | 3.0 | | 5.5 V |
| I_{CES} | $V_{CE} = V_{CES}$, $V_{GE} = 0V$ $T_J = 125^\circ C$ | | | 50 μA 1 mA |
| I_{GES} | $V_{CE} = 0V$, $V_{GE} = \pm 20V$ | | | ± 100 nA |
| $V_{CE(sat)}$ | $I_C = 40A$, $V_{GE} = 15V$ $T_J = 125^\circ C$ | | 2.2 1.7 | 2.5 V V |

| Symbol | Test Conditions ($T_J = 25^\circ\text{C}$, Unless Otherwise Specified) | Characteristic Values | | |
|--------------|---|-----------------------|------|--------------------|
| | | Min. | Typ. | Max. |
| g_{fs} | $I_C = 40\text{A}$, $V_{CE} = 10\text{V}$, Note 1 | 23 | 38 | S |
| C_{ies} | $V_{CE} = 25\text{V}$, $V_{GE} = 0\text{V}$, $f = 1\text{MHz}$ | | 2810 | pF |
| C_{oes} | | | 210 | pF |
| C_{res} | | | 80 | pF |
| Q_g | $I_C = 40\text{A}$, $V_{GE} = 15\text{V}$, $V_{CE} = 0.5 \cdot V_{CES}$ | | 115 | nC |
| Q_{ge} | | | 22 | nC |
| Q_{gc} | | | 43 | nC |
| $t_{d(on)}$ | Inductive Load, $T_J = 125^\circ\text{C}$ $I_C = 40\text{A}$, $V_{GE} = 15\text{V}$ $V_{CE} = 480\text{V}$, $R_G = 3\Omega$ Note 2 | | 21 | ns |
| t_{ri} | | | 33 | ns |
| E_{on} | | | 0.80 | mJ |
| $t_{d(off)}$ | | | 70 | 110 ns |
| t_{fi} | | | 50 | ns |
| E_{off} | | | 0.45 | 0.80 mJ |
| $t_{d(on)}$ | Inductive Load, $T_J = 125^\circ\text{C}$ $I_C = 40\text{A}$, $V_{GE} = 15\text{V}$ $V_{CE} = 480\text{V}$, $R_G = 3\Omega$ Note 2 | | 21 | ns |
| t_{ri} | | | 33 | ns |
| E_{on} | | | 1.25 | mJ |
| $t_{d(off)}$ | | | 112 | ns |
| t_{fi} | | | 86 | ns |
| E_{off} | | | 0.80 | mJ |
| R_{thJC} | | | 0.33 | $^\circ\text{C/W}$ |
| R_{thCK} | | 0.21 | | $^\circ\text{C/W}$ |

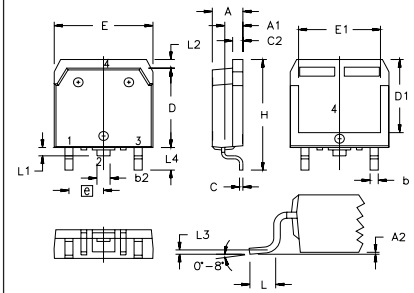
TO-268 (IXGT) Outline

 Terminals: 1 - Gate
 2 - Collector
 3 - Emitter
 Tab - Collector

| SYM | INCHES | | MILLIMETERS | |
|-----|----------|------|-------------|-------|
| | MIN | MAX | MIN | MAX |
| A | .193 | .201 | 4.90 | 5.10 |
| A1 | .106 | .114 | 2.70 | 2.90 |
| A2 | .001 | .010 | 0.02 | 0.25 |
| b | .045 | .057 | 1.15 | 1.45 |
| b2 | .075 | .083 | 1.90 | 2.10 |
| C | .016 | .026 | 0.40 | 0.65 |
| C2 | .057 | .063 | 1.45 | 1.60 |
| D | .543 | .551 | 13.80 | 14.00 |
| D1 | .488 | .500 | 12.40 | 12.70 |
| E | .624 | .632 | 15.85 | 16.05 |
| E1 | .524 | .535 | 13.30 | 13.60 |
| e | .215 BSC | | 5.45 BSC | |
| H | .736 | .752 | 18.70 | 19.10 |
| L | .094 | .106 | 2.40 | 2.70 |
| L1 | .047 | .055 | 1.20 | 1.40 |
| L2 | .039 | .045 | 1.00 | 1.15 |
| L3 | .010 BSC | | 0.25 BSC | |
| L4 | .150 | .161 | 3.80 | 4.10 |

Reverse Diode (FRED)

| Symbol | Test Conditions ($T_J = 25^\circ\text{C}$, Unless Otherwise Specified) | Characteristic Values | | |
|------------|---|-----------------------|------|------------------------|
| | | Min. | Typ. | Max. |
| V_F | $I_F = 30\text{A}$, $V_{GE} = 0\text{V}$, Note 1 $T_J = 150^\circ\text{C}$ | | 1.6 | 2.7 V |
| I_{RM} | $I_F = 30\text{A}$, $V_{GE} = 0\text{V}$, $di_F/dt = 100\text{ A}/\mu\text{s}$, $T_J = 100^\circ\text{C}$ $V_R = 100\text{V}$, $T_J = 100^\circ\text{C}$ $I_F = 1\text{A}$; $-di/dt = 100\text{ A}/\mu\text{s}$, $V_R = 30\text{V}$ | | | 4 A |
| t_{rr} | | | 100 | ns |
| | | | 25 | ns |
| R_{thJC} | | | | 0.9 $^\circ\text{C/W}$ |

Notes:

1. Pulse test, $t \leq 300\mu\text{s}$, duty cycle, $d \leq 2\%$.
2. Switching times & energy losses may increase for higher $V_{CE}(\text{Clamp})$, T_J or R_G .

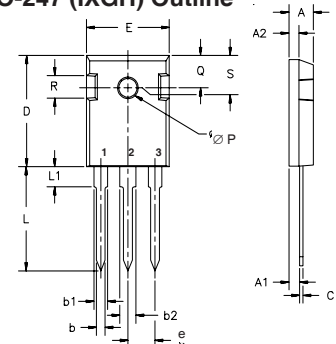
TO-247 (IXGH) Outline

 Terminals: 1 - Gate
 2 - Collector
 3 - Emitter
 Tab - Collector

| Dim. | Millimeter | | Inches | |
|----------------|------------|-------|----------|-------|
| | Min. | Max. | Min. | Max. |
| A | 4.7 | 5.3 | .185 | .209 |
| A ₁ | 2.2 | 2.54 | .087 | .102 |
| A ₂ | 2.2 | 2.6 | .059 | .098 |
| b | 1.0 | 1.4 | .040 | .055 |
| b ₁ | 1.65 | 2.13 | .065 | .084 |
| b ₂ | 2.87 | 3.12 | .113 | .123 |
| C | .4 | .8 | .016 | .031 |
| D | 20.80 | 21.46 | .819 | .845 |
| E | 15.75 | 16.26 | .610 | .640 |
| e | 5.20 | 5.72 | 0.205 | 0.225 |
| L | 19.81 | 20.32 | .780 | .800 |
| L1 | | 4.50 | | .177 |
| ∅P | 3.55 | 3.65 | .140 | .144 |
| Q | 5.89 | 6.40 | 0.232 | 0.252 |
| R | 4.32 | 5.49 | .170 | .216 |
| S | 6.15 BSC | | .242 BSC | |

IXYS Reserves the Right to Change Limits, Test Conditions, and Dimensions.

Fig. 1. Output Characteristics @ $T_J = 25^\circ\text{C}$

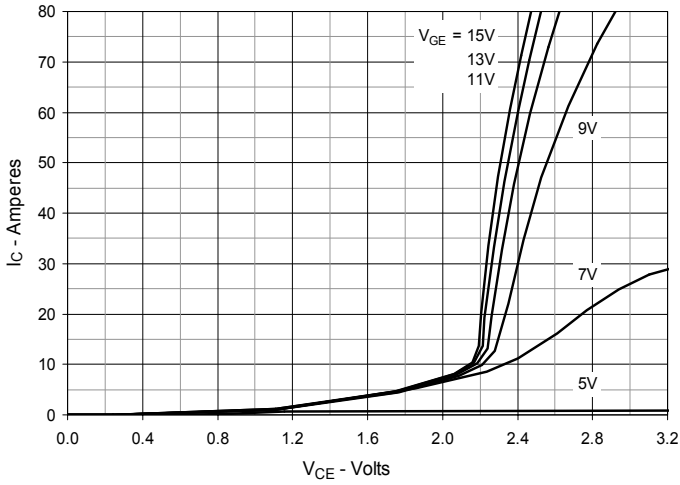

Fig. 2. Extended Output Characteristics @ $T_J = 25^\circ\text{C}$

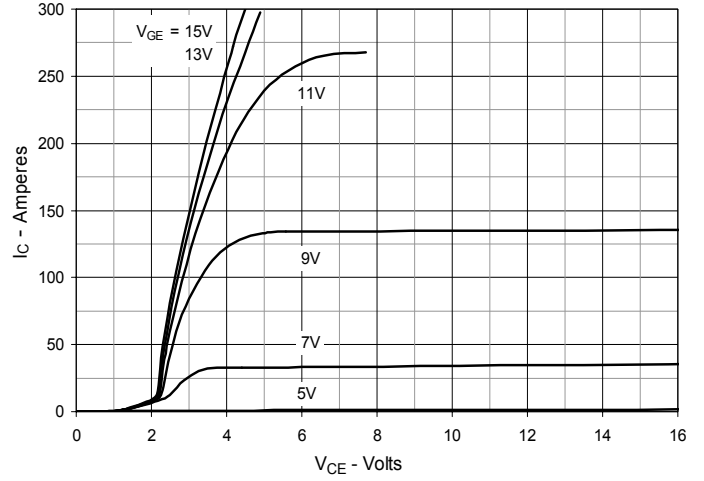

Fig. 3. Output Characteristics @ $T_J = 125^\circ\text{C}$

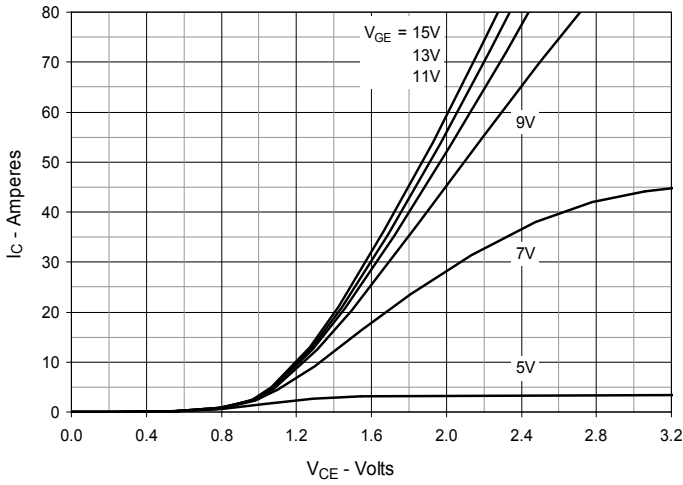

Fig. 4. Dependence of $V_{CE(sat)}$ on Junction Temperature

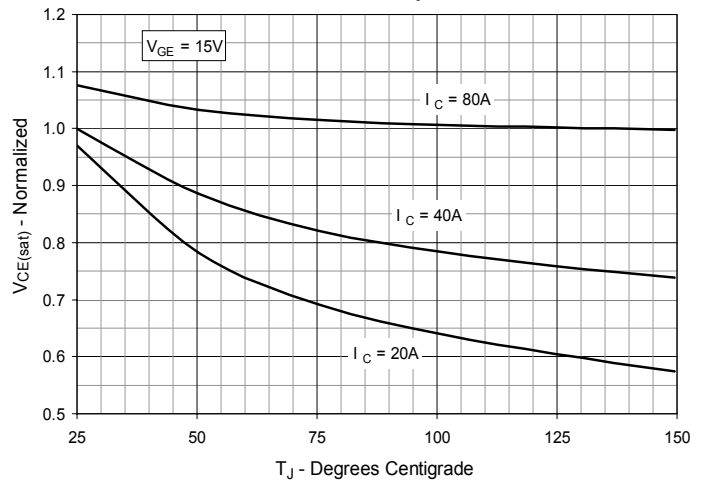

Fig. 5. Collector-to-Emitter Voltage vs. Gate-to-Emitter Voltage

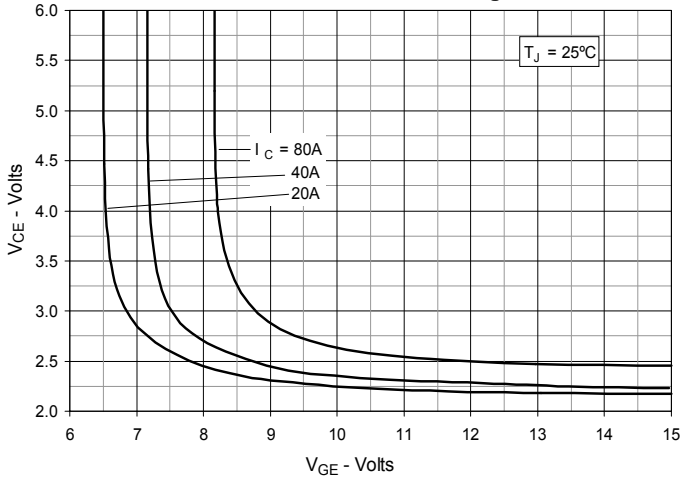

Fig. 6. Input Admittance

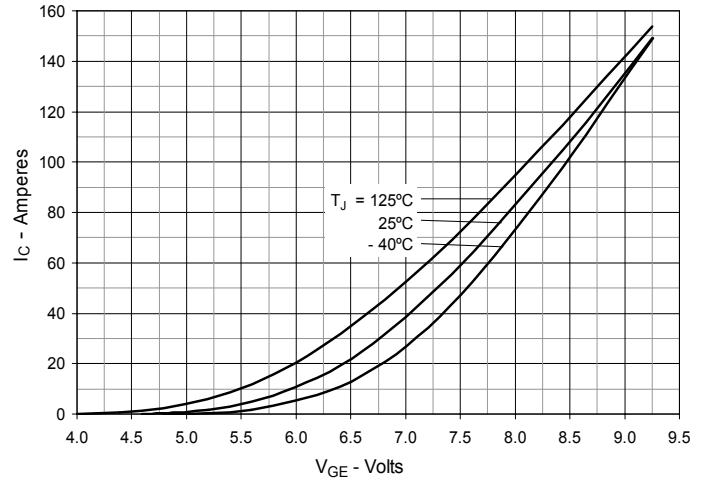

Fig. 7. Transconductance

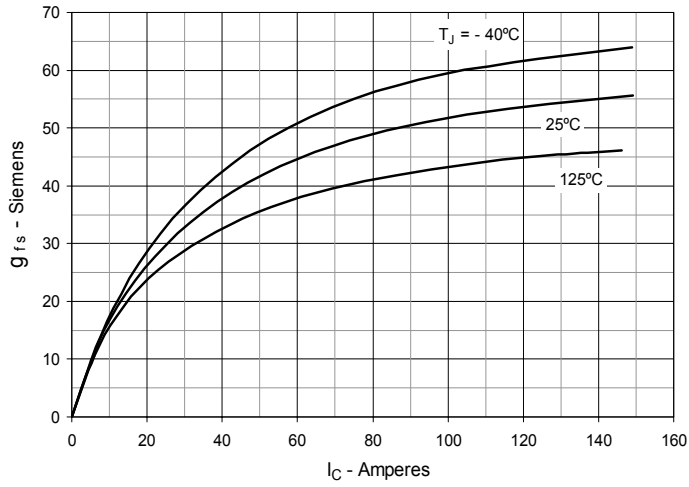

Fig. 8. Gate Charge

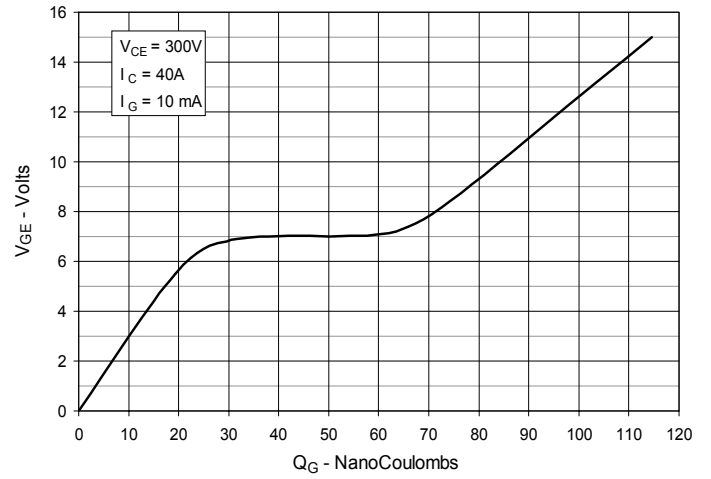

Fig. 9. Capacitance

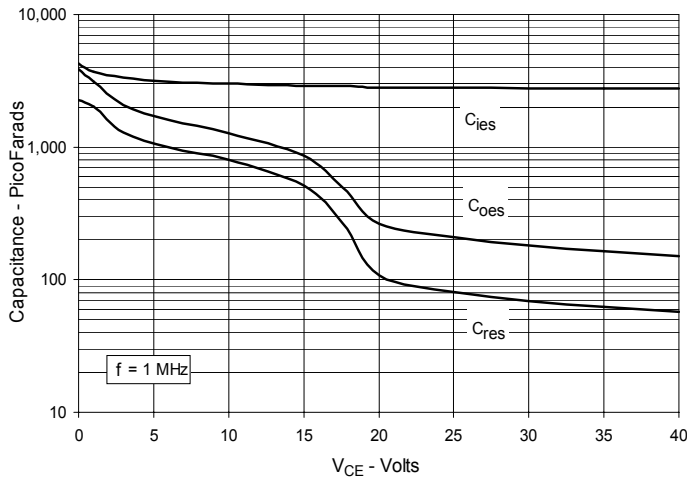

Fig. 10. Reverse-Bias Safe Operating Area

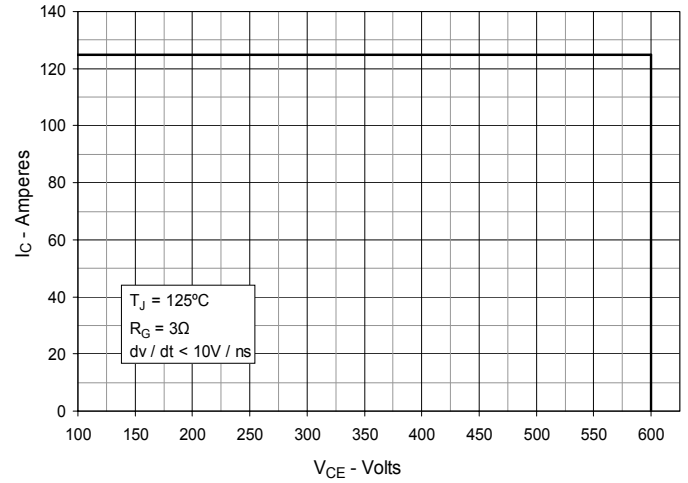

Fig. 11. Maximum Transient Thermal Impedance

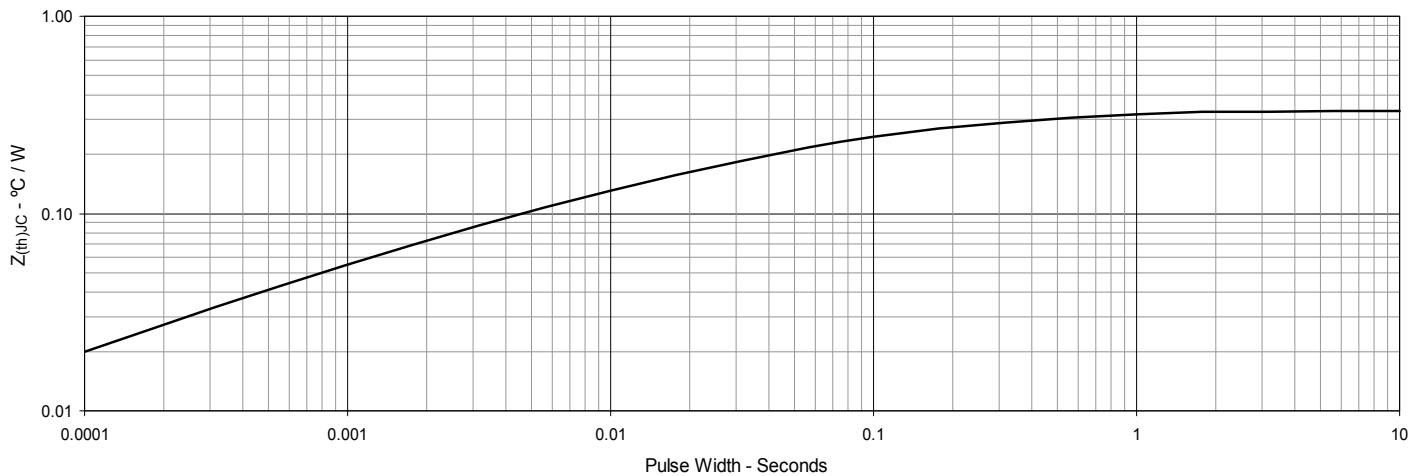

Fig. 12. Inductive Switching Energy Loss vs. Gate Resistance

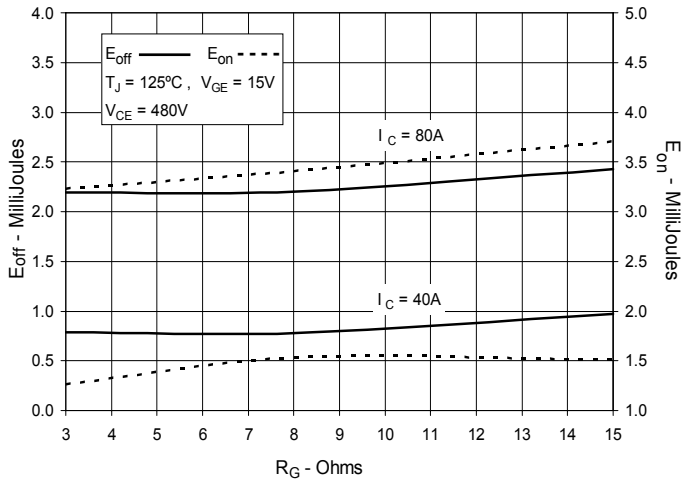

Fig. 13. Inductive Switching Energy Loss vs. Collector Current

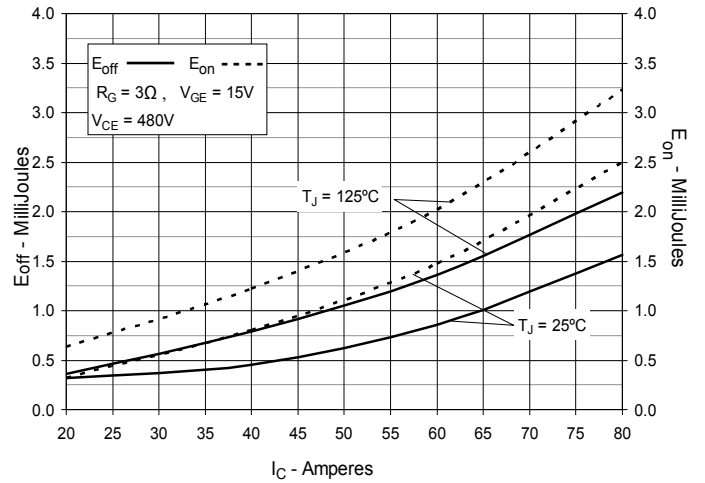

Fig. 14. Inductive Switching Energy Loss vs. Junction Temperature

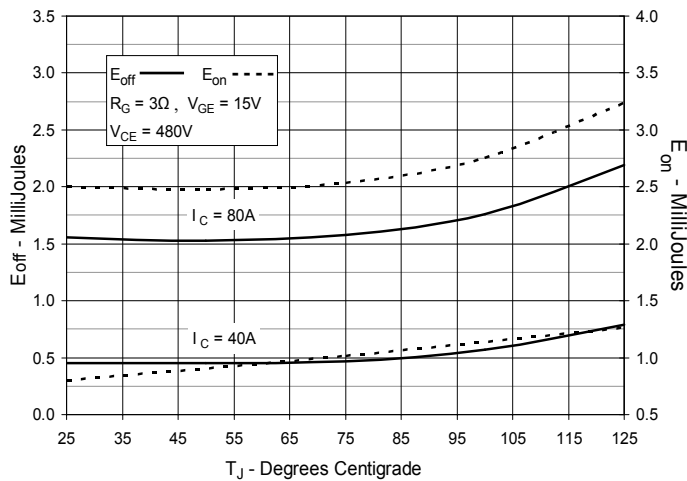

Fig. 15. Inductive Turn-off Switching Times vs. Gate Resistance

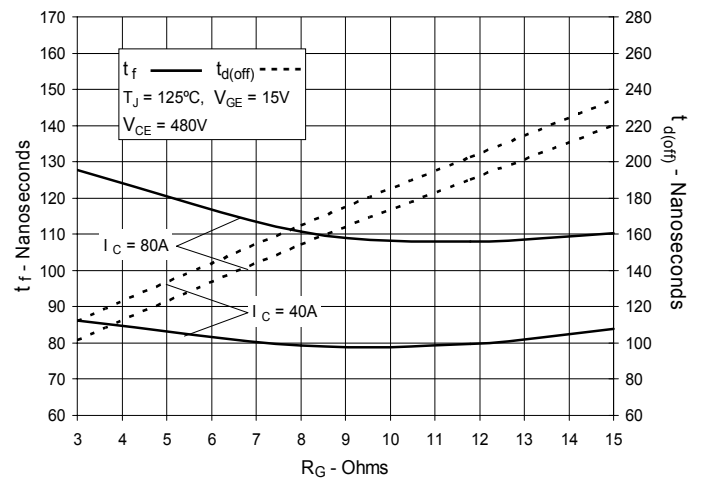

Fig. 16. Inductive Turn-off Switching Times vs. Collector Current

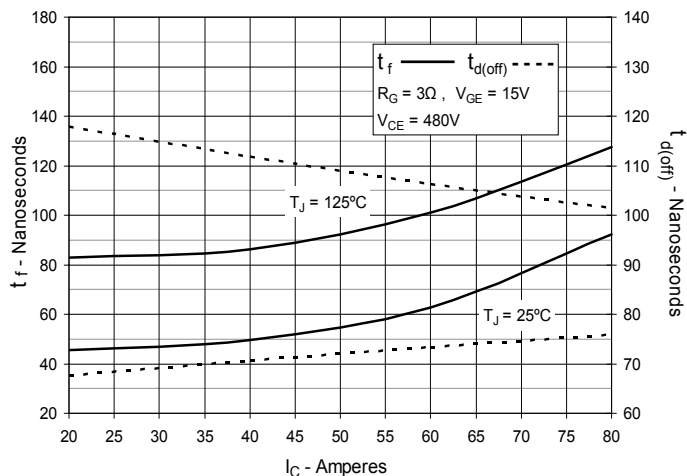

Fig. 17. Inductive Turn-off Switching Times vs. Junction Temperature

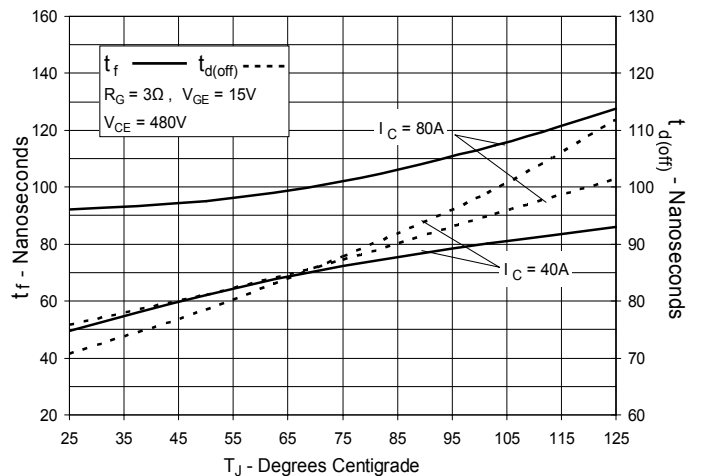

Fig. 18. Inductive Turn-on Switching Times vs. Gate Resistance

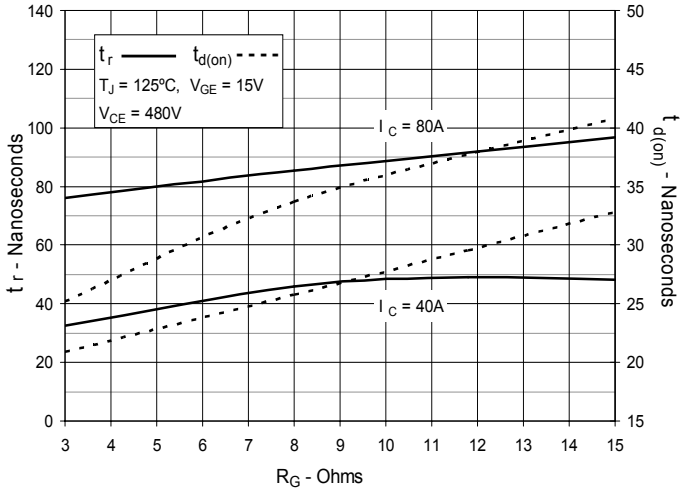

Fig. 19. Inductive Turn-on Switching Times vs. Collector Current

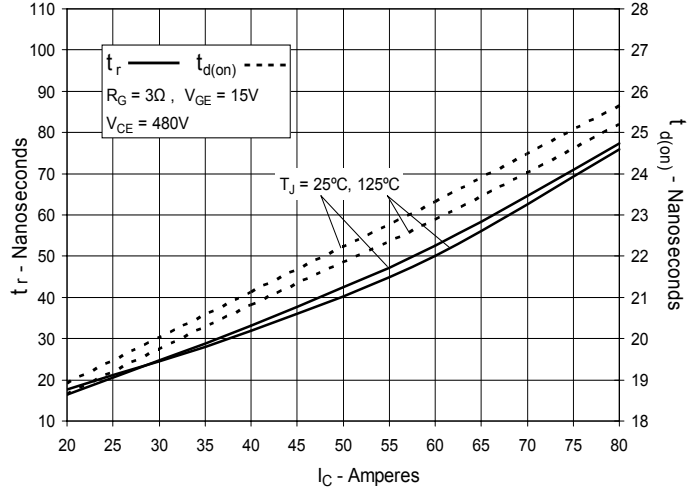
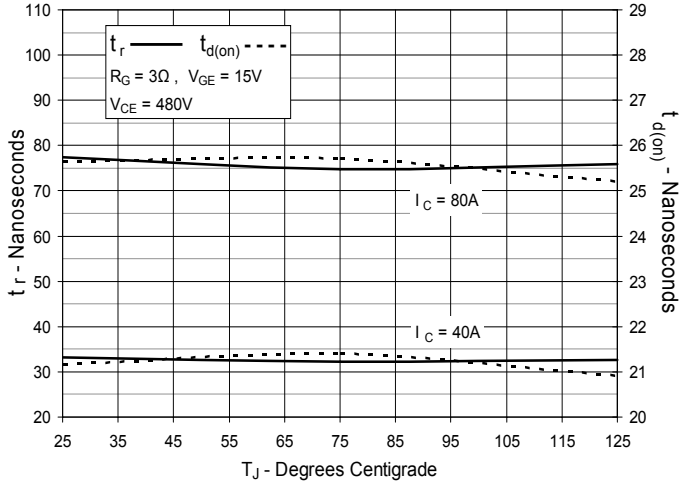

Fig. 20. Inductive Turn-on Switching Times vs. Junction Temperature



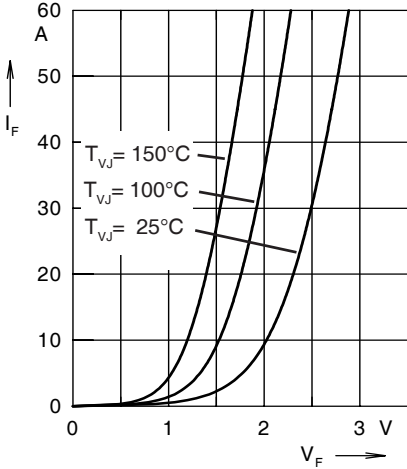

Fig. 21 Forward current I_F versus V_F

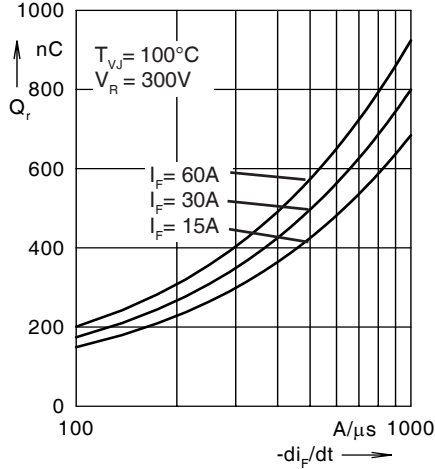

Fig. 22 Reverse recovery charge Q_r versus $-di_F/dt$

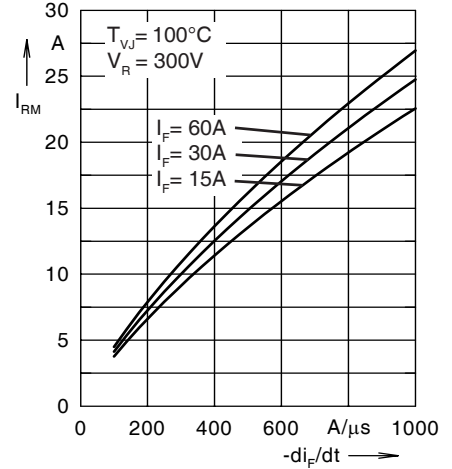

Fig. 23 Peak reverse current I_{RM} versus $-di_F/dt$

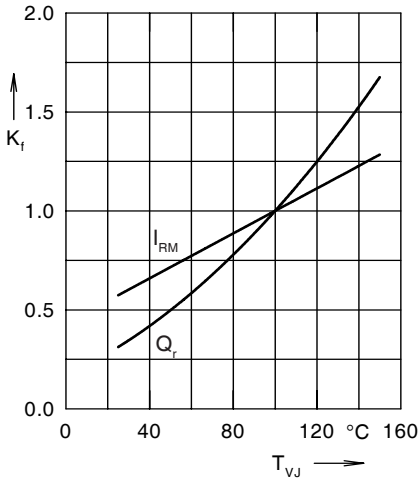

Fig. 24 Dynamic parameters Q_r , I_{RM} versus T_{VJ}

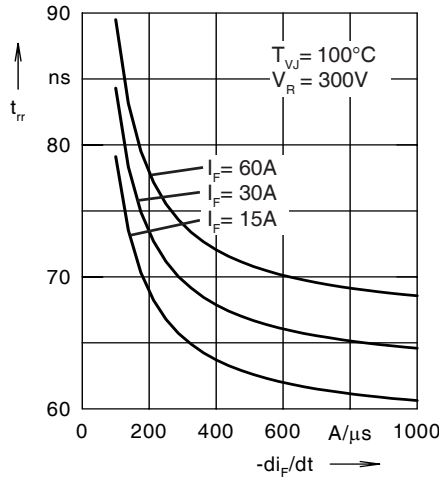

Fig. 25 Recovery time t_{rr} versus $-di_F/dt$

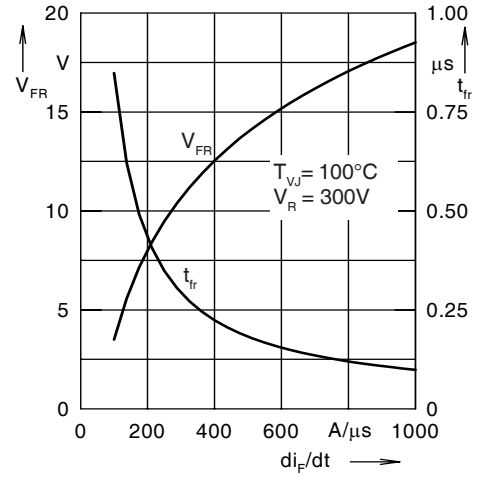

Fig. 26 Peak forward voltage V_{FR} and t_{fr} versus di_F/dt

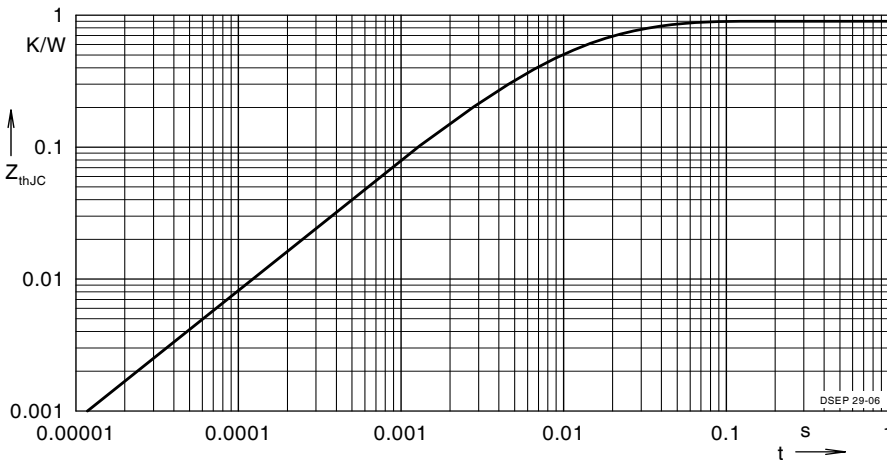

Fig. 27 Transient thermal resistance junction to case

Constants for Z_{thJC} calculation:

| i | R_{thi} (K/W) | t_i (s) |
|---|-----------------|-----------|
| 1 | 0.502 | 0.0052 |
| 2 | 0.193 | 0.0003 |
| 3 | 0.205 | 0.0162 |