

GenX3™ B3-Class IGBTs

IXGH72N60B3 IXGT72N60B3

Medium Speed low V_{sat} PT IGBTs 5-40 kHz Switching

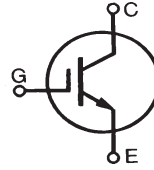

$V_{CES} = 600V$
 $I_{C110} = 72A$
 $V_{CE(sat)} \leq 1.80V$
 $t_{fi(typ)} = 90ns$

| Symbol | Test Conditions | Maximum Ratings | |
|-------------------------------|---|---------------------------------------|------------|
| V_{CES} | $T_J = 25^\circ C$ to $150^\circ C$ | 600 | V |
| V_{CGR} | $T_J = 25^\circ C$ to $150^\circ C$, $R_{GE} = 1M\Omega$ | 600 | V |
| V_{GES} | Continuous | ± 20 | V |
| V_{GEM} | Transient | ± 30 | V |
| I_{C25} | $T_C = 25^\circ C$ (Limited by Leads) | 75 | A |
| I_{C110} | $T_C = 110^\circ C$ | 72 | A |
| I_{CM} | $T_C = 25^\circ C$, 1ms | 400 | A |
| I_A | $T_C = 25^\circ C$ | 20 | A |
| E_{AS} | $T_C = 25^\circ C$ | 200 | mJ |
| SSOA (RBSOA) | $V_{GE} = 15V$, $T_{VJ} = 125^\circ C$, $R_G = 3\Omega$ Clamped Inductive Load | $I_{CM} = 240$ @ $V_{CE} \leq 600$ | A V |
| P_C | $T_C = 25^\circ C$ | 540 | W |
| T_J | | -55 ... +150 | $^\circ C$ |
| T_{JM} | | 150 | $^\circ C$ |
| T_{stg} | | -55 ... +150 | $^\circ C$ |
| M_d | Mounting Torque (TO-247) | 1.13 / 10 | Nm/lb.in. |
| T_L | 1.6mm (0.062 in.) from Case for 10s | 300 | $^\circ C$ |
| T_{SOLD} | Plastic Body for 10 seconds | 260 | $^\circ C$ |
| Weight | TO-247 | 6 | g |
| | TO-268 | 5 | g |

TO-247 AD (IXGH)

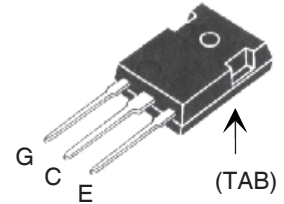

TO-268 (IXGT)

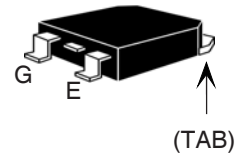

G = Gate C = Collector
E = Emitter TAB = Collector

Features

- Optimized for Low Conduction and Switching Losses
- Square RBSOA
- Avalanche Rated
- International Standard Packages

Advantages

- High Power Density
- Low Gate Drive Requirement

Applications

- Power Inverters
- UPS
- Motor Drives
- SMPS
- PFC Circuits
- Battery Chargers
- Welding Machines
- Lamp Ballasts

| Symbol | Test Conditions ($T_J = 25^\circ C$, Unless Otherwise Specified) | Characteristic Values | | |
|---------------|---|-----------------------|------|---------------------------|
| | | Min. | Typ. | Max. |
| BV_{CES} | $I_C = 250\mu A$, $V_{GE} = 0V$ | 600 | | V |
| $V_{GE(th)}$ | $I_C = 250\mu A$, $V_{CE} = V_{GE}$ | 3.0 | | V |
| I_{CES} | $V_{CE} = V_{CES}$, $V_{GE} = 0V$ $T_J = 125^\circ C$ | | | 75 μA 750 μA |
| I_{GES} | $V_{CE} = 0V$, $V_{GE} = \pm 20V$ | | | ± 100 nA |
| $V_{CE(sat)}$ | $I_C = 60A$, $V_{GE} = 15V$, Note 1 $T_J = 125^\circ C$ | 1.51 | | V |
| | | 1.48 | | V |

| Symbol | Test Conditions ($T_J = 25^\circ\text{C}$, Unless Otherwise Specified) | Characteristic Values | | |
|--------------|---|-----------------------|------|-------------------------|
| | | Min. | Typ. | Max. |
| g_{fs} | $I_C = 60\text{A}, V_{CE} = 10\text{V}$, Note 1 | 50 | 83 | S |
| C_{ies} | $V_{CE} = 25\text{V}, V_{GE} = 0\text{V}, f = 1\text{MHz}$ | | 6800 | pF |
| C_{oes} | | | 575 | pF |
| C_{res} | | | 80 | pF |
| Q_g | $I_C = 60\text{A}, V_{GE} = 15\text{V}, V_{CE} = 0.5 \cdot V_{CES}$ | | 230 | nC |
| Q_{ge} | | | 40 | nC |
| Q_{gc} | | | 82 | nC |
| $t_{d(on)}$ | Inductive load, $T_J = 25^\circ\text{C}$ $I_C = 50\text{A}, V_{GE} = 15\text{V}$ $V_{CE} = 480\text{V}, R_G = 3\Omega$ | | 31 | ns |
| t_{ri} | | | 33 | ns |
| E_{on} | | | 1.38 | mJ |
| $t_{d(off)}$ | | | 150 | 330 ns |
| t_{fi} | | | 90 | 160 ns |
| E_{off} | | | 1.05 | 2.0 mJ |
| $t_{d(on)}$ | Inductive load, $T_J = 125^\circ\text{C}$ $I_C = 50\text{A}, V_{GE} = 15\text{V}$ $V_{CE} = 480\text{V}, R_G = 3\Omega$ | | 29 | ns |
| t_{ri} | | | 34 | ns |
| E_{on} | | | 2.70 | mJ |
| $t_{d(off)}$ | | | 228 | ns |
| t_{fi} | | | 142 | ns |
| E_{off} | | | 2.20 | mJ |
| R_{thJC} | (TO-247) | | | 0.23 $^\circ\text{C/W}$ |
| R_{thCS} | | | 0.25 | $^\circ\text{C/W}$ |

TO-247 AD Outline

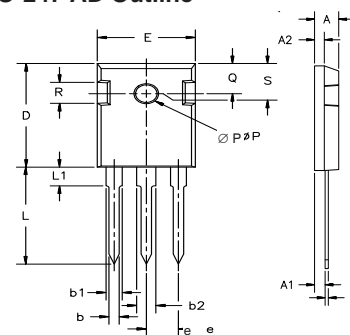

| Dim. | Millimeter | | Inches | |
|----------------|------------|-------|--------|-------|
| | Min. | Max. | Min. | Max. |
| A | 4.7 | 5.3 | .185 | .209 |
| A ₁ | 2.2 | 2.54 | .087 | .102 |
| A ₂ | 2.2 | 2.6 | .059 | .098 |
| b | 1.0 | 1.4 | .040 | .055 |
| b ₁ | 1.65 | 2.13 | .065 | .084 |
| b ₂ | 2.87 | 3.12 | .113 | .123 |
| C | .4 | .8 | .016 | .031 |
| D | 20.80 | 21.46 | .819 | .845 |
| E | 15.75 | 16.26 | .610 | .640 |
| e | 5.20 | 5.72 | 0.205 | 0.225 |
| L | 19.81 | 20.32 | .780 | .800 |
| L ₁ | | 4.50 | | .177 |
| ∅P | 3.55 | 3.65 | .140 | .144 |
| Q | 5.89 | 6.40 | 0.232 | 0.252 |
| R | 4.32 | 5.49 | .170 | .216 |
| S | 6.15 | BSC | .242 | BSC |

TO-268 Outline

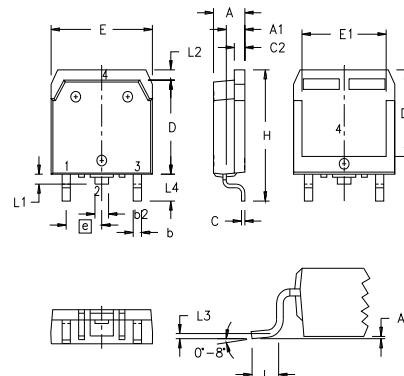

| SYM | INCHES | | MILLIMETERS | |
|-----|----------|------|-------------|-------|
| | MIN | MAX | MIN | MAX |
| A | .193 | .201 | 4.90 | 5.10 |
| A1 | .106 | .114 | 2.70 | 2.90 |
| A2 | .001 | .010 | 0.02 | 0.25 |
| b | .045 | .057 | 1.15 | 1.45 |
| b2 | .075 | .083 | 1.90 | 2.10 |
| C | .016 | .026 | 0.40 | 0.65 |
| C2 | .057 | .063 | 1.45 | 1.60 |
| D | .543 | .551 | 13.80 | 14.00 |
| D1 | .488 | .500 | 12.40 | 12.70 |
| E | .624 | .632 | 15.85 | 16.05 |
| E1 | .524 | .535 | 13.30 | 13.60 |
| e | .215 BSC | | 5.45 BSC | |
| H | .736 | .752 | 18.70 | 19.10 |
| L | .094 | .106 | 2.40 | 2.70 |
| L1 | .047 | .055 | 1.20 | 1.40 |
| L2 | .039 | .045 | 1.00 | 1.15 |
| L3 | .010 BSC | | 0.25 BSC | |
| L4 | .150 | .161 | 3.80 | 4.10 |

Note 1: Pulse Test, $t \leq 300\mu\text{s}$, Duty Cycle, $d \leq 2\%$.

IXYS Reserves the Right to Change Limits, Test Conditions, and Dimensions.

IXYS MOSFETs and IGBTs are covered by one or more of the following U.S. patents:

| | | | | | | | | | |
|-----------|-----------|-----------|-----------|--------------|--------------|--------------|--------------|--------------|-------------|
| 4,835,592 | 4,931,844 | 5,049,961 | 5,237,481 | 6,162,665 | 6,404,065 B1 | 6,683,344 | 6,727,585 | 7,005,734 B2 | 7,157,338B2 |
| 4,850,072 | 5,017,508 | 5,063,307 | 5,381,025 | 6,259,123 B1 | 6,534,343 | 6,710,405 B2 | 6,759,692 | 7,063,975 B2 | |
| 4,881,106 | 5,034,796 | 5,187,117 | 5,486,715 | 6,306,728 B1 | 6,583,505 | 6,710,463 | 6,771,478 B2 | 7,071,537 | |

Fig. 1. Output Characteristics @ 25°C

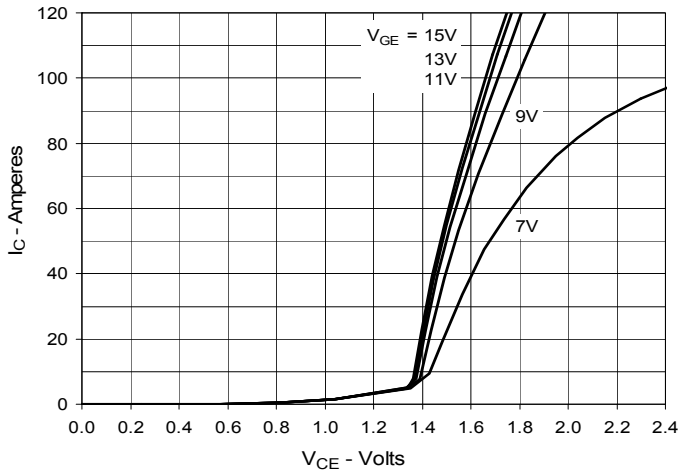

Fig. 2. Extended Output Characteristics @ 25°C

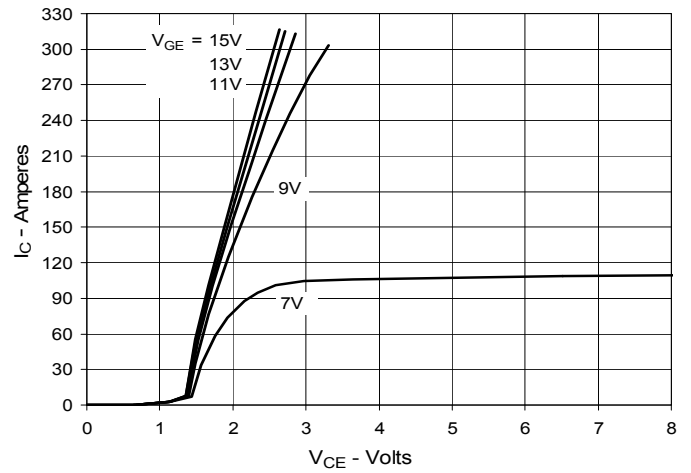

Fig. 3. Output Characteristics @ 125°C

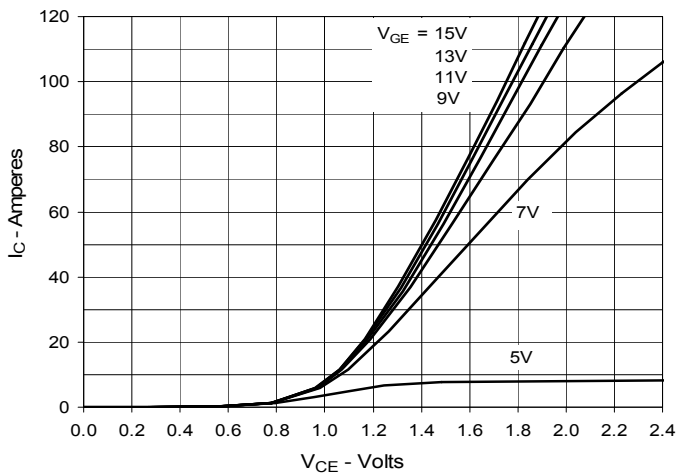

Fig. 4. Dependence of Vce(sat) on Junction Temperature

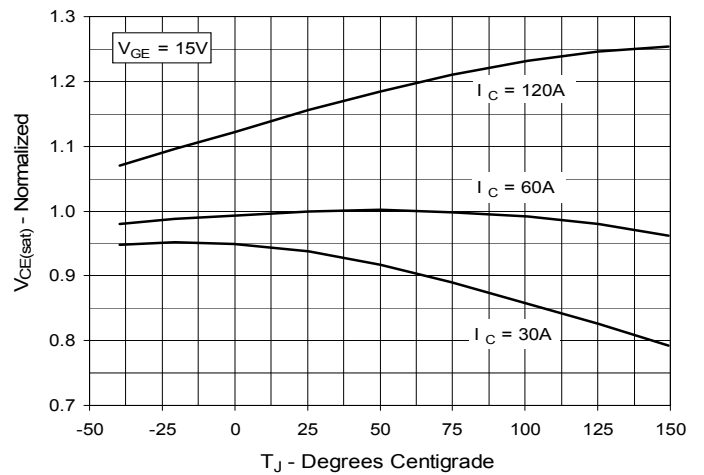

Fig. 5. Collector-to-Emitter Voltage vs. Gate-to-Emitter Voltage

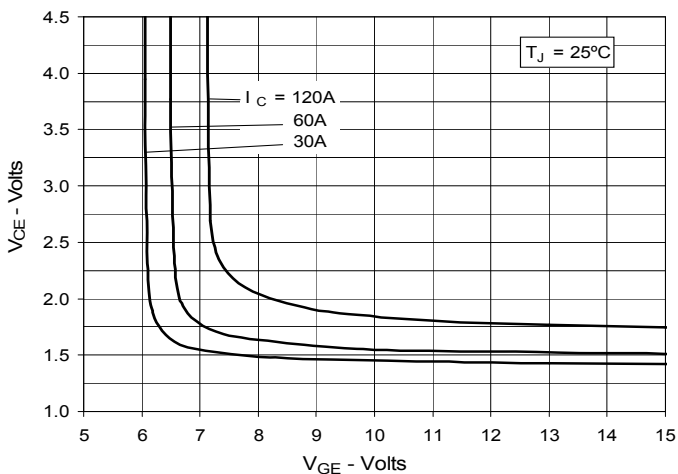

Fig. 6. Input Admittance

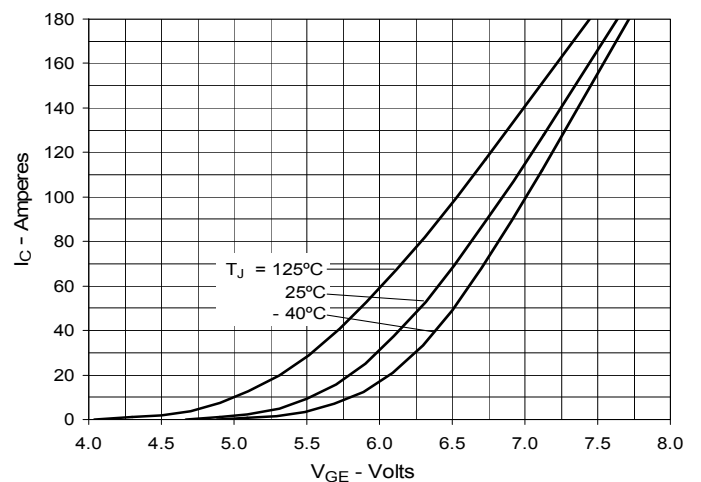

Fig. 7. Transconductance

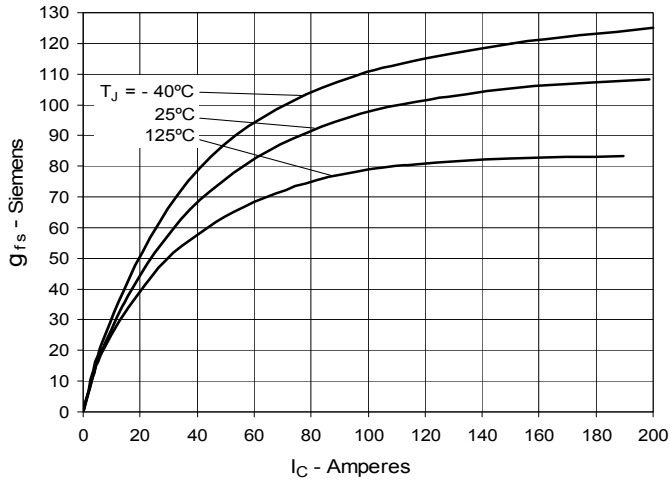

Fig. 8. Gate Charge

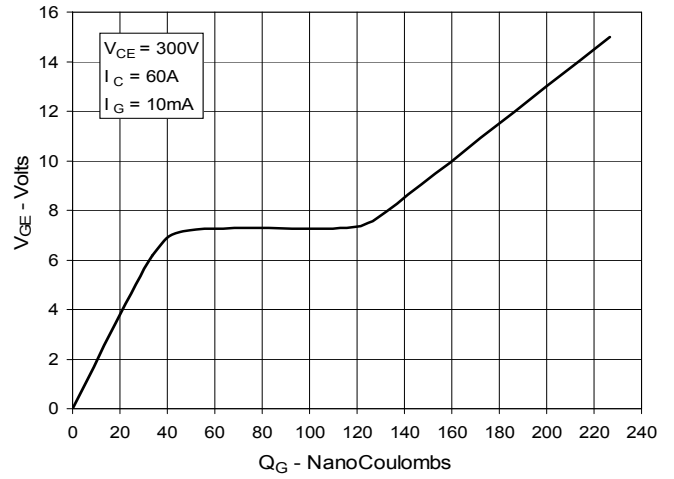

Fig. 9. Capacitance

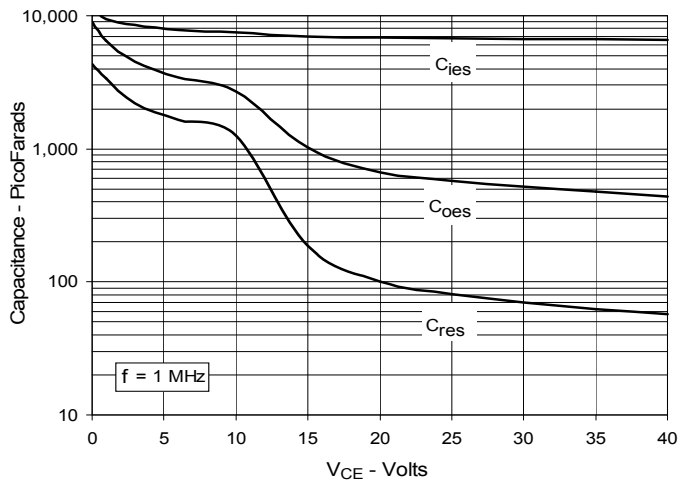

Fig. 10. Reverse-Bias Safe Operating Area

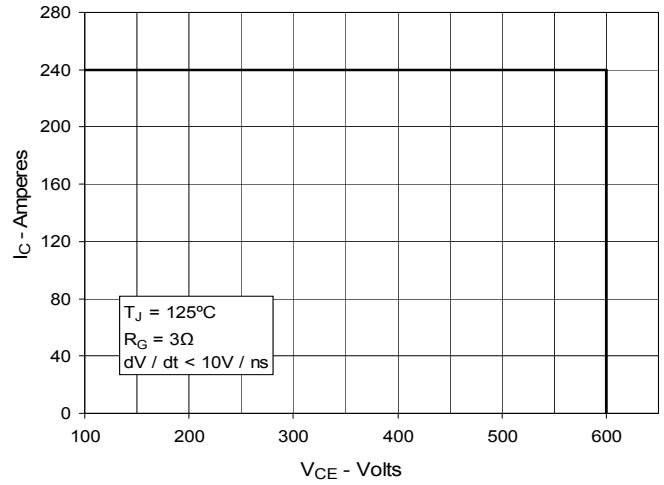

Fig. 11. Maximum Transient Thermal Impedance

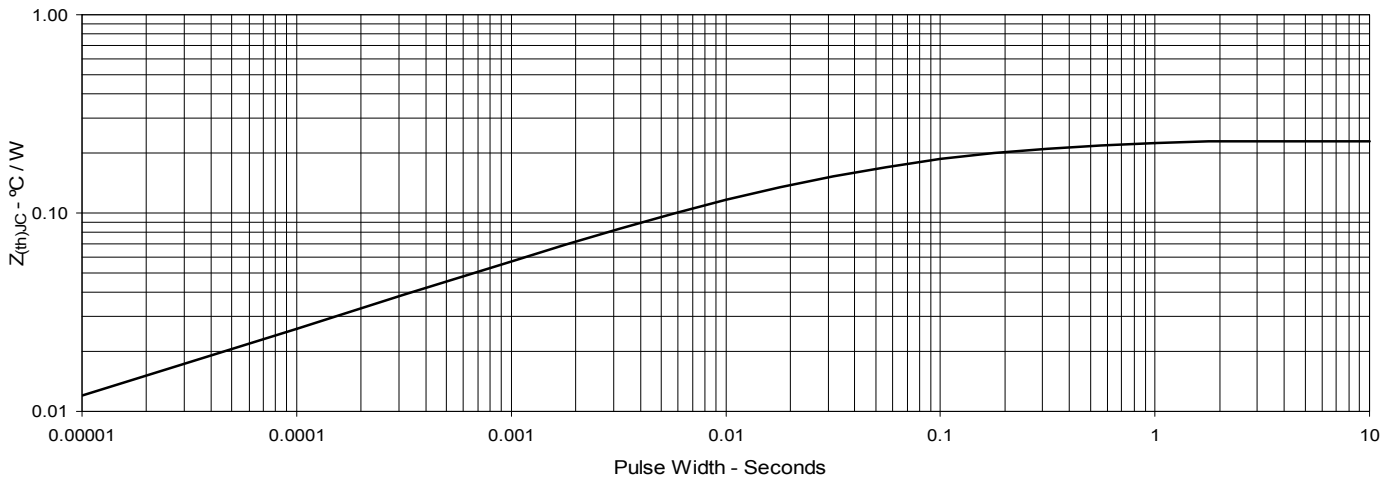

Fig. 12. Inductive Switching Energy Loss vs. Gate Resistance

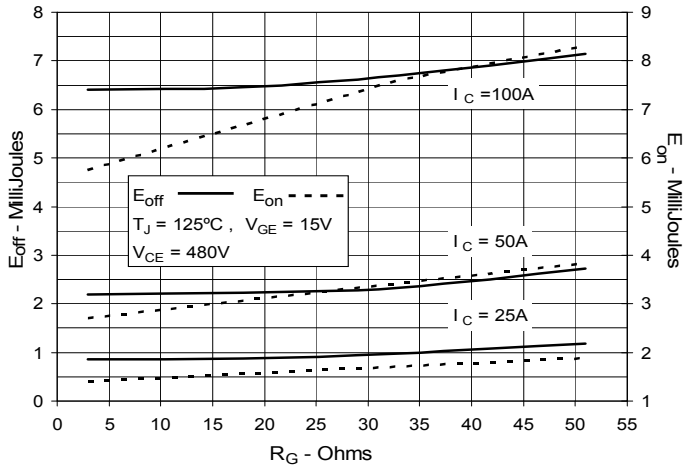

Fig. 13. Inductive Switching Energy Loss vs. Collector Current

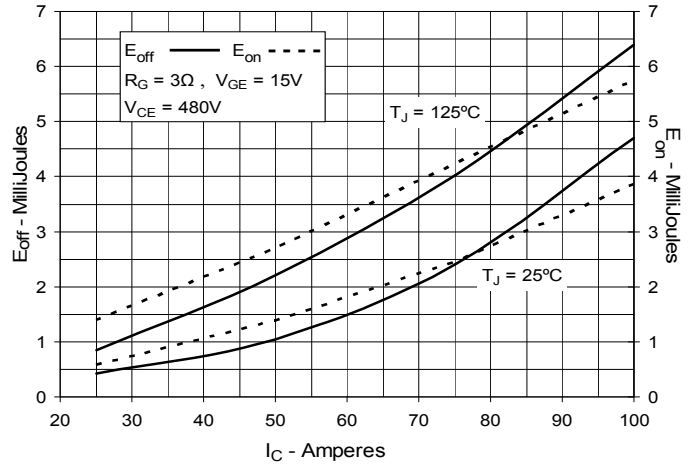

Fig. 14. Inductive Switching Energy Loss vs. Junction Temperature

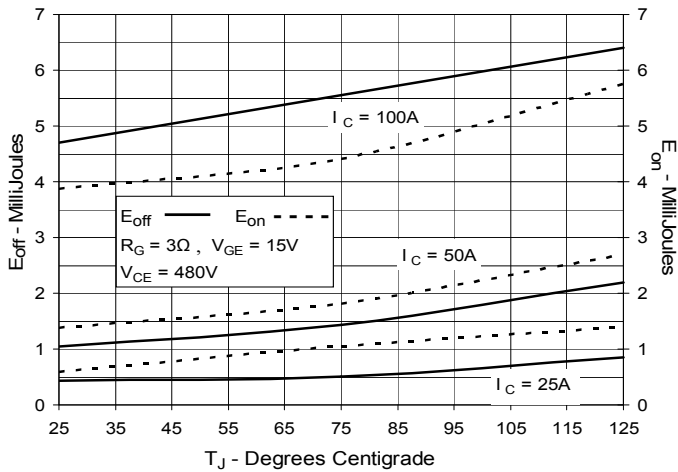

Fig. 15. Inductive Turn-off Switching Times vs. Gate Resistance

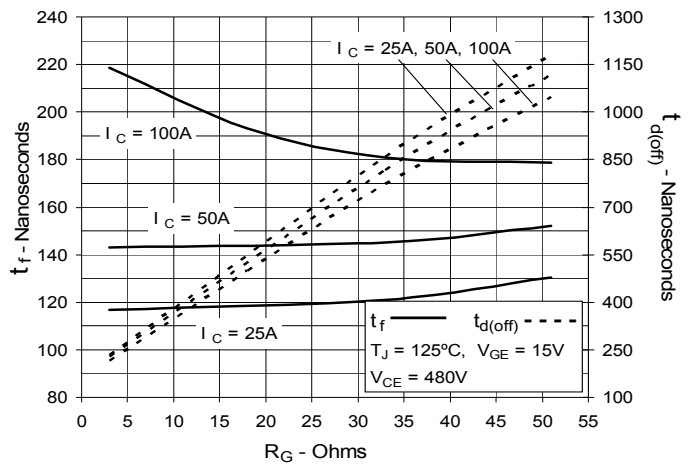

Fig. 16. Inductive Turn-off Switching Times vs. Collector Current

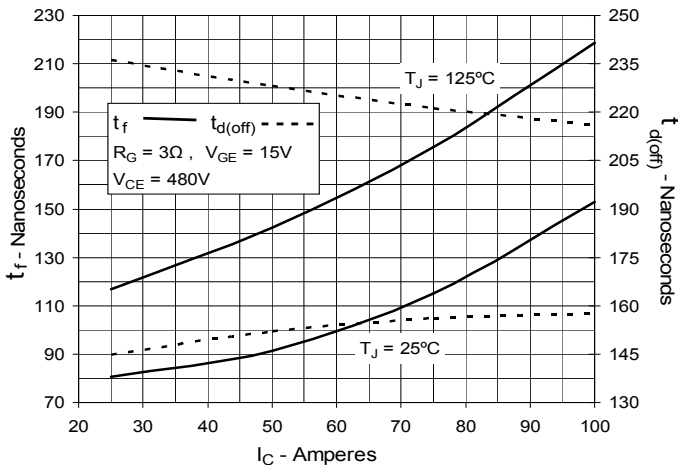
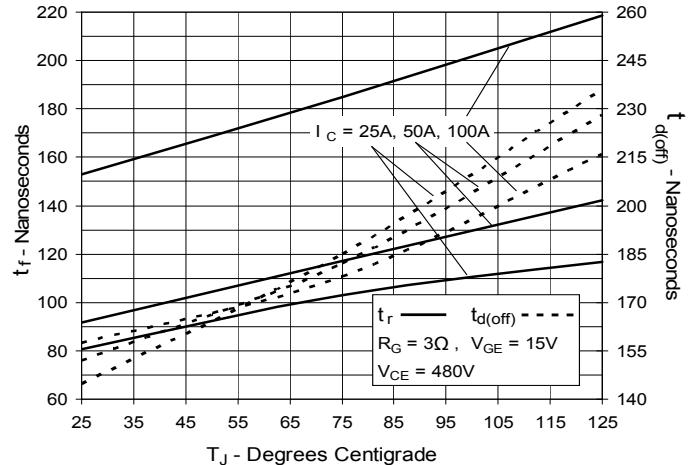
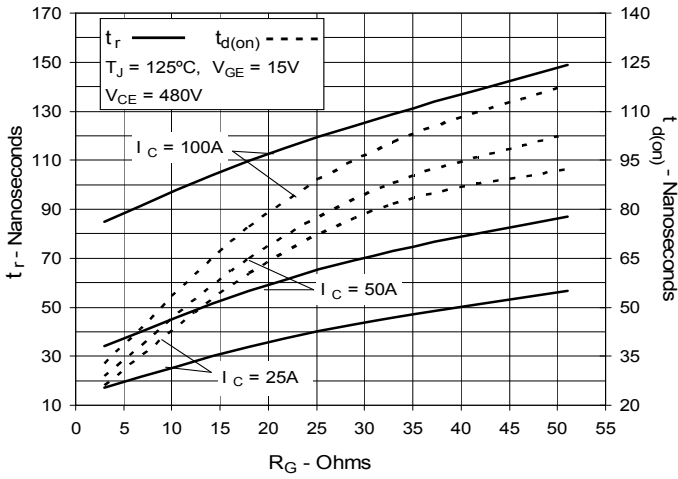

Fig. 17. Inductive Turn-off Switching Times vs. Junction Temperature



**Fig. 18. Inductive Turn-on
Switching Times vs. Gate Resistance**



**Fig. 19. Inductive Turn-on
Switching Times vs. Collector Current**

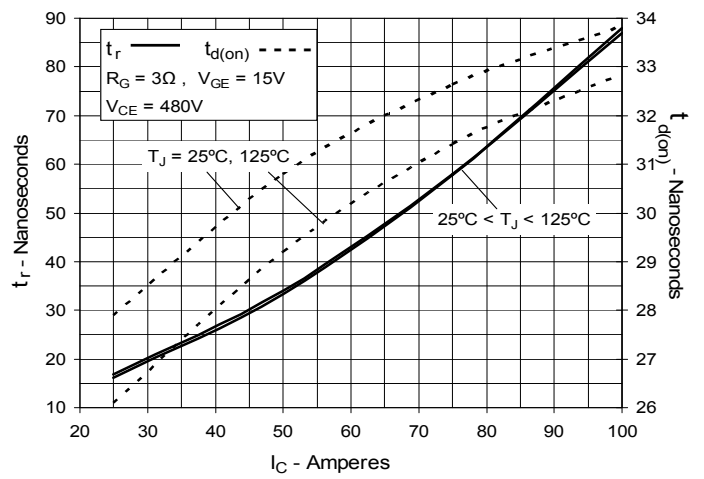

**Fig. 20. Inductive Turn-on
Switching Times vs. Junction Temperature**

