

HiPerFAST™ IGBTs w/ Diode

IXGT40N60C2D1
IXGJ40N60C2D1
IXGH40N60C2D1

V_{CES} = 600V
I_{C110} = 40A
V_{CE(SAT)} ≤ 2.7V
t_{fi(typ)} = 32ns

C2-Class High Speed IGBTs



Symbol	Test Conditions	Maximum Ratings	
V _{CES}	T _J = 25°C to 150°C	600	V
V _{CGR}	T _J = 25°C to 150°C, R _{GE} = 1MΩ	600	V
V _{GES}	Continuous	±20	V
V _{GEM}	Transient	±30	V
I _{C25}	T _C = 25°C (Limited by Lead)	75	A
I _{C110}	T _C = 110°C	40	A
I _{CM}	T _C = 25°C, 1ms	200	A
SSOA (RBSOA)	V _{GE} = 15V, T _J = 125°C, R _G = 10Ω Clamped Inductive Load	I _{CM} = 80 V _{CE} ≤ V _{CES}	A
P _C	T _C = 25°C	300	W
T _J		-55 ... +150	°C
T _{JM}		150	°C
T _{stg}		-55 ... +150	°C
T _L	1.6mm (0.062 in.) from Case for 10s	300	°C
T _{SOLD}	Plastic Body for 10 seconds	260	°C
M _d	Mounting Torque (TO-247)	1.13/10	Nm/lb.in.
Weight	TO-247	6	g
	TO-268	4	g

Symbol	Test Conditions (T _J = 25°C, Unless Otherwise Specified)	Characteristic Values		
		Min.	Typ.	Max.
V _{GE(th)}	I _C = 250μA, V _{CE} = V _{GE}	3.0		5.0 V
I _{CES}	V _{CE} = V _{CES} , V _{GE} = 0V T _J = 125°C			200 μA 3 mA
I _{GES}	V _{CE} = 0V, V _{GE} = ±20V			±100 nA
V _{CE(sat)}	I _C = 30A, V _{GE} = 15V, Note 1 T _J = 125°C		2.2 1.7	2.7 V V

TO-268 (IXGT)

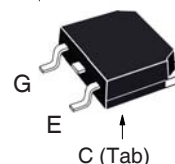

TO-268 (IXGJ)

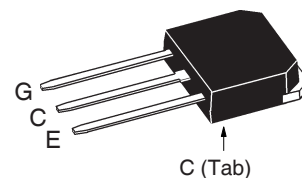

TO-247 (IXGH)

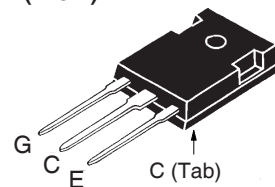

G = Gate C = Collector
E = Emitter Tab = Collector

Features

- Very High Frequency IGBT
- Square RBSOA
- High Current Handling Capability

Applications

- Uninterruptible Power Supplies (UPS)
- Switch-Mode and Resonant-Mode Power Supplies
- AC Motor Speed Control
- DC Servo and Robot Drives
- DC Choppers

Advantages

- High Power Density
- Very Fast Switching Speeds for High Frequency Applications
- High Power Surface Mountable Packages

Symbol Test Conditions

($T_J = 25^\circ\text{C}$ Unless Otherwise Specified)

Characteristic Values

		Min.	Typ.	Max.	
g_{fs}	$I_C = 30\text{A}, V_{CE} = 10\text{V}$, Note 1	20	36		S
C_{ies}	$V_{CE} = 25\text{V}, V_{GE} = 0\text{V}, f = 1\text{MHz}$		2500		pF
C_{oes}			220		pF
C_{res}			54		pF
Q_g	$I_C = 30\text{A}, V_{GE} = 15\text{V}, V_{CE} = 0.5 \cdot V_{CES}$		95		nC
Q_{ge}			14		nC
Q_{gc}			36		nC
$t_{d(on)}$	Inductive load, $T_J = 25^\circ\text{C}$		18		ns
t_{ri}		$I_C = 30\text{A}, V_{GE} = 15\text{V}$		20	
$t_{d(off)}$	$V_{CE} = 400\text{V}, R_G = 3\Omega$		90	140	ns
t_{fi}			32		ns
E_{off}	Note 2		0.20	0.37	mJ
$t_{d(on)}$	Inductive load, $T_J = 125^\circ\text{C}$		18		ns
t_{ri}		$I_C = 30\text{A}, V_{GE} = 15\text{V}$		20	
E_{on}	$V_{CE} = 400\text{V}, R_G = 3\Omega$		0.60		mJ
$t_{d(off)}$			130		ns
t_{fi}	Note 2		80		ns
E_{off}			0.50		mJ
R_{thJC}				0.42	$^\circ\text{C/W}$
R_{thCS}	TO-247 & TO-268		0.25		$^\circ\text{C/W}$

Reverse Diode (FRED)

Symbol Test Conditions

($T_J = 25^\circ\text{C}$ Unless Otherwise Specified)

Characteristic Values

		Min.	Typ.	Max.	
V_F	$I_F = 30\text{A}, V_{GE} = 0\text{V}$, Note 1			2.5	V
I_{RM}	$I_F = 30\text{A}, V_{GE} = 0\text{V}, -di_F/dt = 100\text{A}/\mu\text{s}$			4	A
t_{rr}	$V_R = 100\text{V}$		100		ns
	$I_F = 1\text{A}, V_{GE} = 0\text{V}, -di_F/dt = 100\text{A}/\mu\text{s}, V_R = 30\text{V}$		25		ns
R_{thJC}				0.9	$^\circ\text{C/W}$

Notes:

1. Pulse test, $t \leq 300\mu\text{s}$, duty cycle, $d \leq 2\%$.
2. Switching times & energy losses may increase for higher V_{CE} (clamp), T_J or R_G .

TO-268 Outline

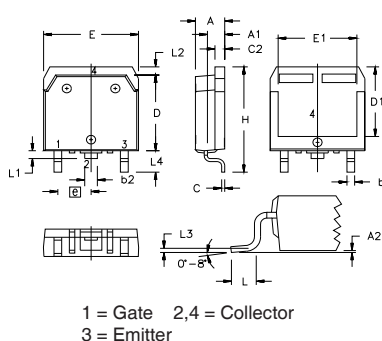

SYM	INCHES		MILLIMETERS	
	MIN	MAX	MIN	MAX
A	.193	.201	4.90	5.10
A1	.106	.114	2.70	2.90
A2	.001	.010	0.02	0.25
b	.045	.057	1.15	1.45
b2	.075	.083	1.90	2.10
C	.016	.026	0.40	0.65
C2	.057	.063	1.45	1.60
D	.543	.551	13.80	14.00
D1	.488	.500	12.40	12.70
E	.624	.632	15.85	16.05
E1	.524	.535	13.30	13.60
e	.215 BSC		5.45 BSC	
H	.736	.752	18.70	19.10
L	.094	.106	2.40	2.70
L1	.047	.055	1.20	1.40
L2	.039	.045	1.00	1.15
L3	.010 BSC		0.25 BSC	
L4	.150	.161	3.80	4.10

IXYS Reserves The Right to Change Limits, Test Conditions, and Dimensions.

IXYS MOSFETs and IGBTs are covered by one or more of the following U.S. patents:	4,835,592	4,931,844	5,049,961	5,237,481	6,162,665	6,404,065 B1	6,683,344	6,727,585	7,005,734 B2	7,157,338B2
	4,850,072	5,017,508	5,063,307	5,381,025	6,259,123 B1	6,534,343	6,710,405 B2	6,759,692	7,063,975 B2	
	4,881,106	5,034,796	5,187,117	5,486,715	6,306,728 B1	6,583,505	6,710,463	6,771,478 B2	7,071,537	

TO-247 Outline

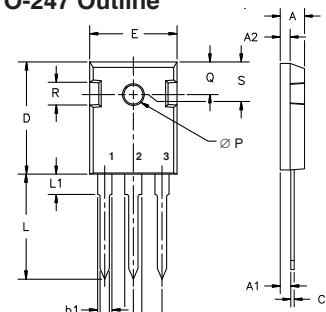

Dim.	Millimeter		Inches	
	Min.	Max.	Min.	Max.
A	4.7	5.3	.185	.209
A ₁	2.2	2.54	.087	.102
A ₂	2.2	2.6	.059	.098
b	1.0	1.4	.040	.055
b ₁	1.65	2.13	.065	.084
b ₂	2.87	3.12	.113	.123
C	.4	.8	.016	.031
D	20.80	21.46	.819	.845
E	15.75	16.26	.610	.640
e	5.20	5.72	0.205	0.225
L	19.81	20.32	.780	.800
L1		4.50		.177
∅P	3.55	3.65	.140	.144
Q	5.89	6.40	0.232	0.252
R	4.32	5.49	.170	.216
S	6.15	BSC	242	BSC

TO-268 Ledged Outline

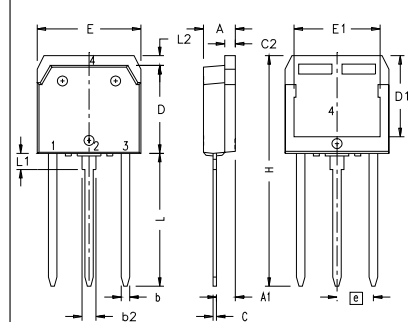

SYM	INCHES		MILLIMETERS	
	MIN	MAX	MIN	MAX
A	.193	.201	4.90	5.10
A1	.106	.114	2.70	2.90
b	.045	.057	1.15	1.45
b2	.075	.083	1.90	2.10
C	.016	.026	0.40	0.65
C2	.057	.063	1.45	1.60
D	.543	.551	13.80	14.00
D1	.488	.500	12.40	12.70
E	.624	.632	15.85	16.05
E1	.524	.535	13.30	13.60
e	.215 BSC		5.45 BSC	
H	1.365	1.395	34.67	35.43
L	.780	.800	19.81	20.32
L1	.079	.091	2.00	2.30
L2	.039	.045	1.00	1.15

NOTE: ALL METAL AREA ARE SOLDER PLATED.

- 1 - GATE
- 2 - DRAIN (COLLECTOR)
- 3 - SOURCE (EMITTER)
- 4 - DRAIN (COLLECTOR)

Fig. 1. Output Characteristics
@ 25 Deg. C

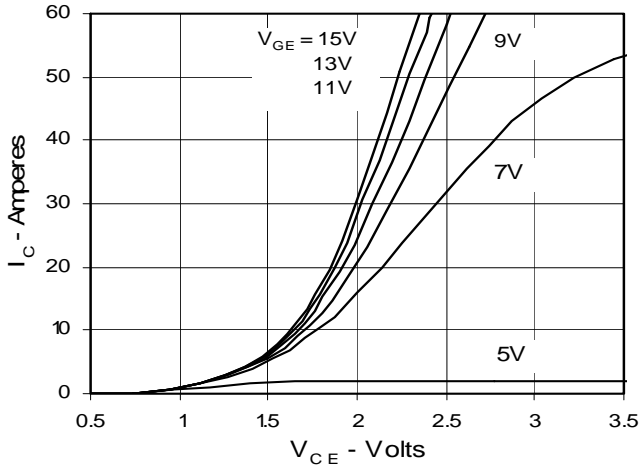

Fig. 2. Extended Output Characteristics
@ 25 deg. C

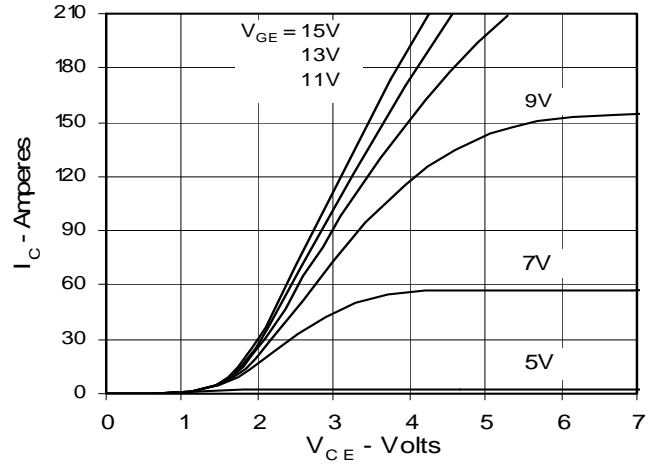

Fig. 3. Output Characteristics
@ 125 Deg. C

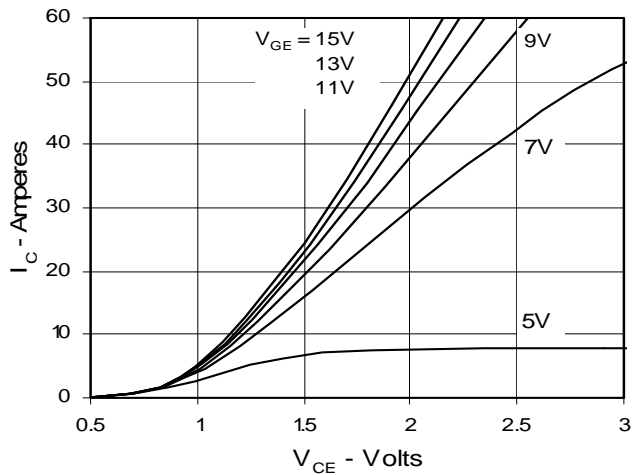

Fig. 4. Temperature Dependence of $V_{CE(sat)}$

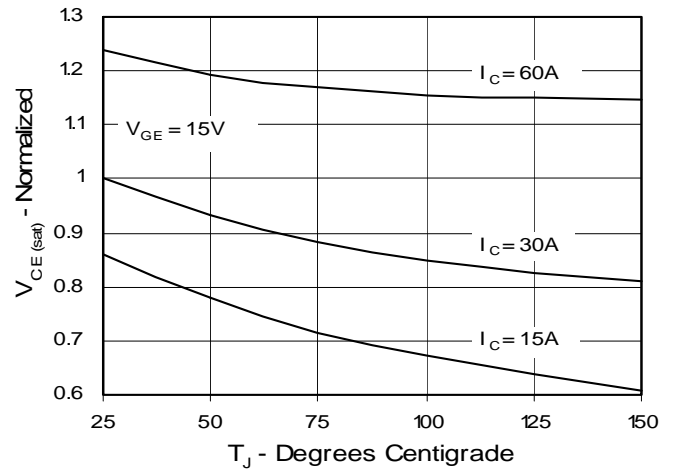

Fig. 5. Collector-to-Emitter Voltage
vs. Gate-to-Emitter voltage

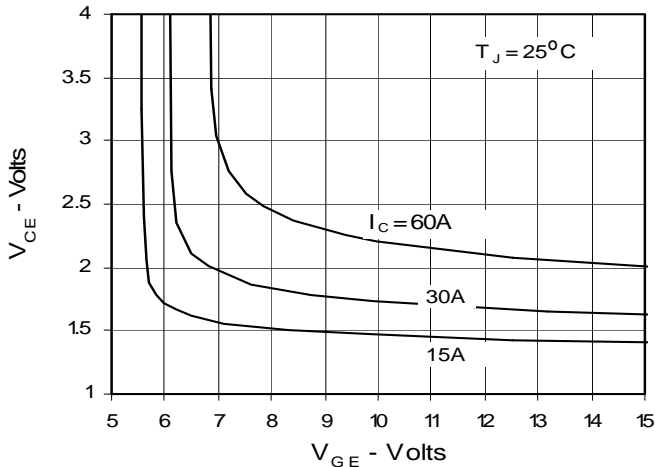

Fig. 6. Input Admittance

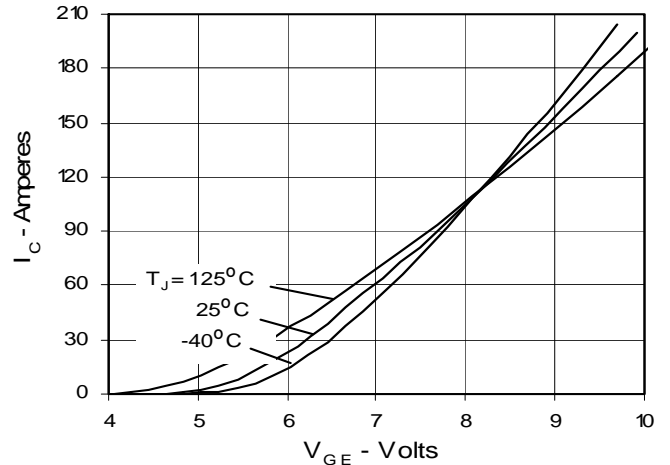

Fig. 7. Transconductance

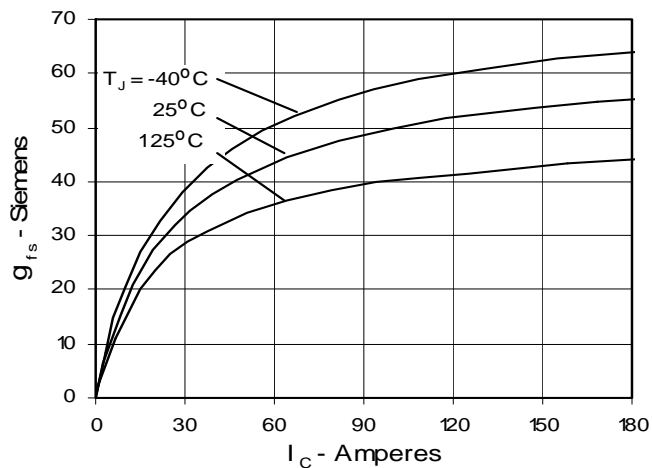

Fig. 8. Dependence of E_{off} on R_G

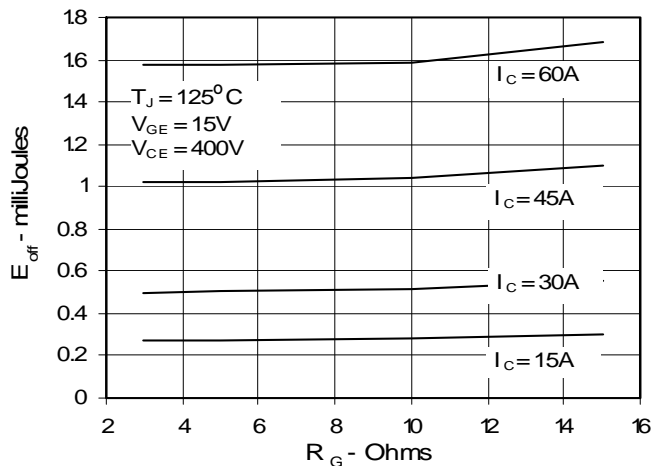

Fig. 9. Dependence of E_{off} on I_C

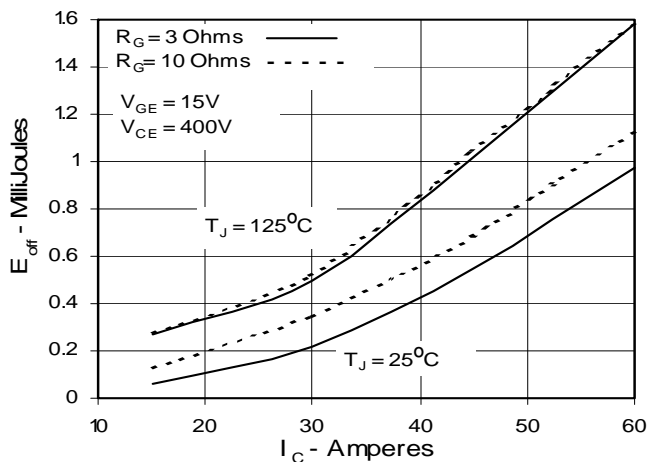

Fig. 10. Dependence of E_{off} on Temperature

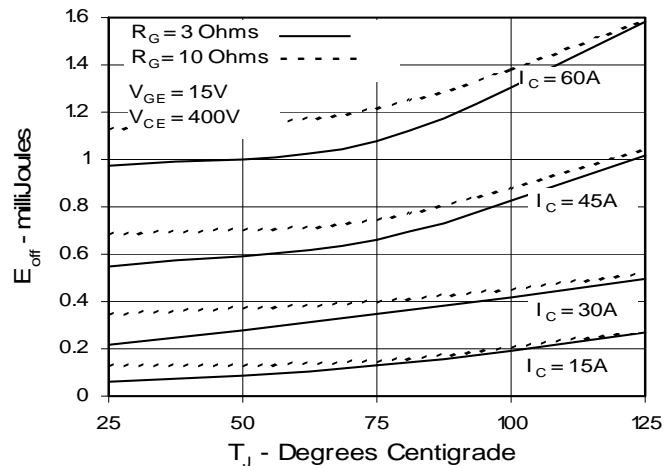

Fig. 11. Gate Charge

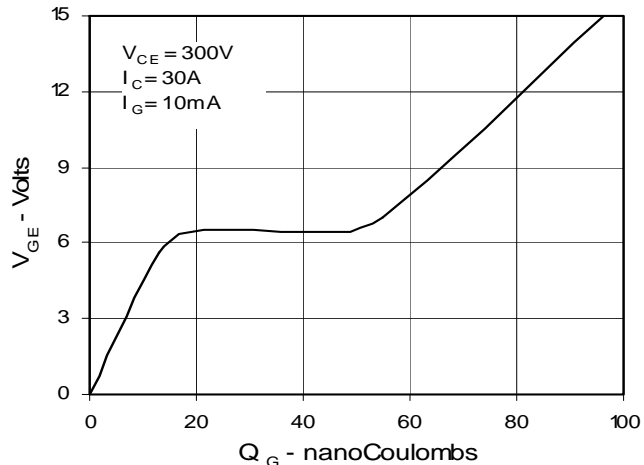

Fig. 12. Capacitance

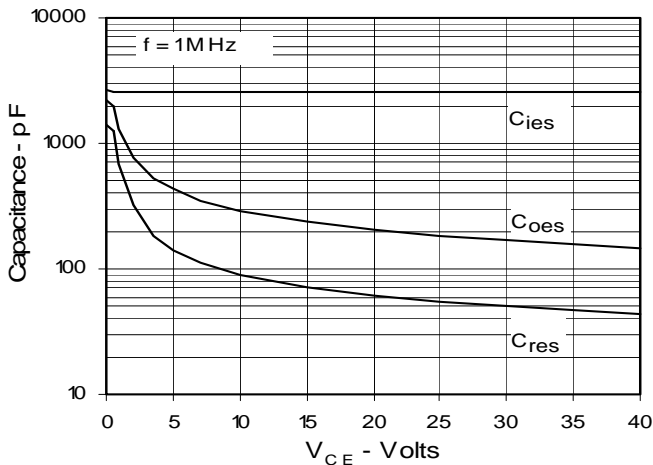
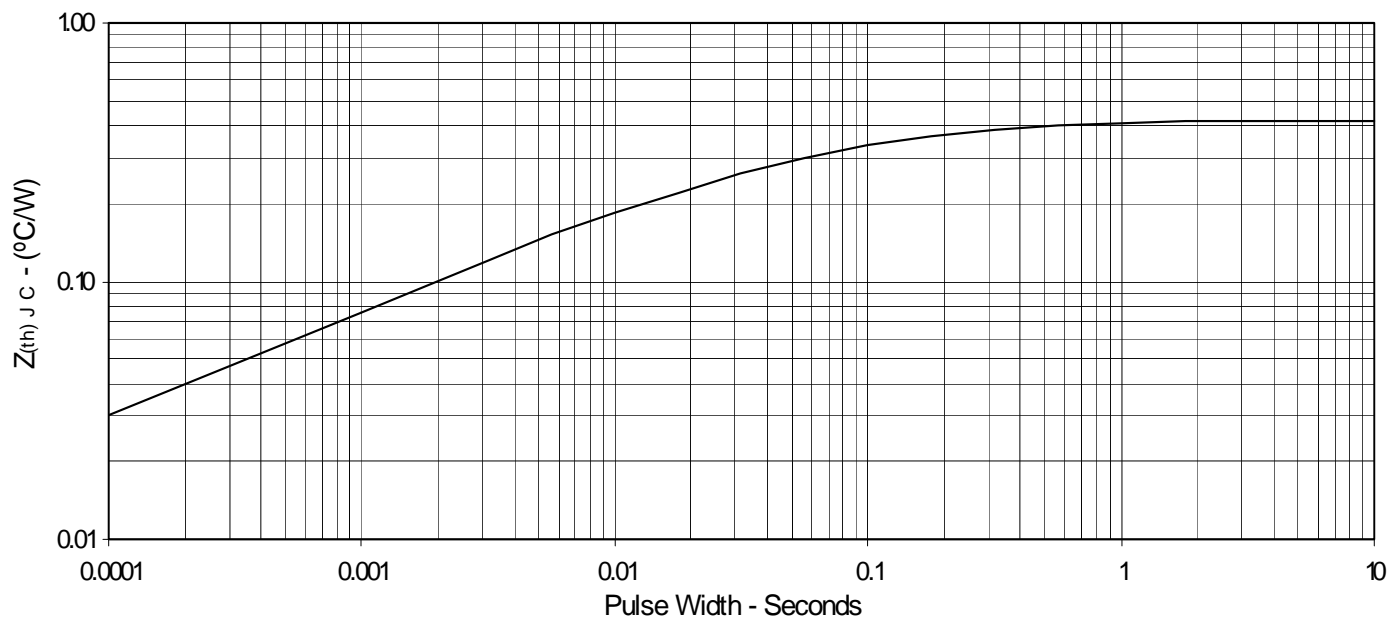

Fig. 13. Maximum Transient Thermal Impedance



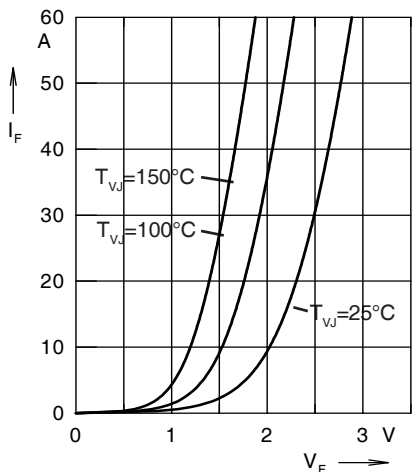

Fig. 14. Forward current I_F versus V_F

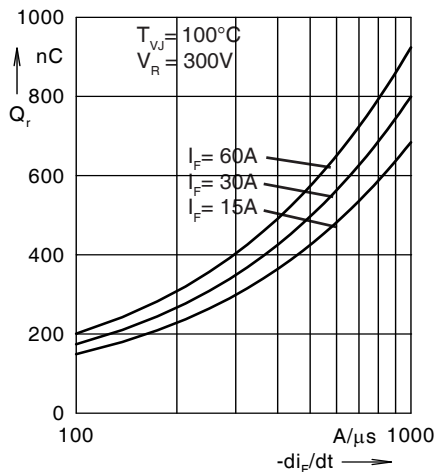

Fig. 15. Reverse recovery charge Q_r versus $-di_F/dt$

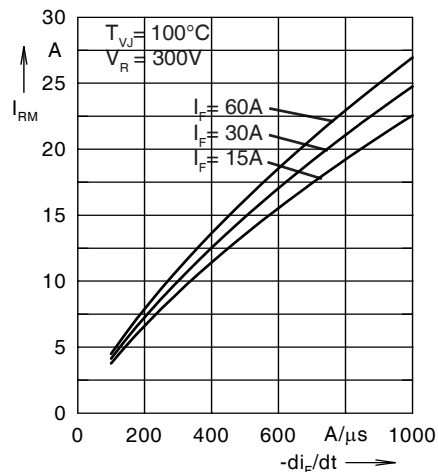

Fig. 16. Peak reverse current I_{RM} versus $-di_F/dt$

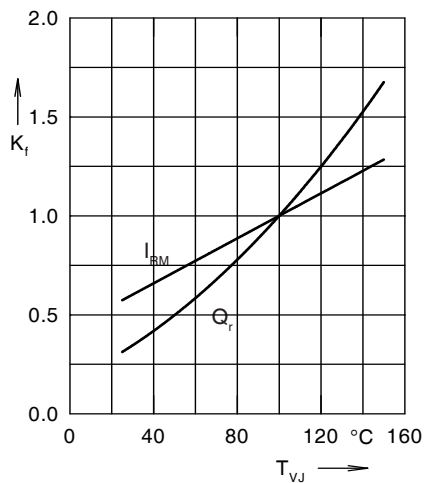

Fig. 17. Dynamic parameters Q_r , I_{RM} versus T_{VJ}

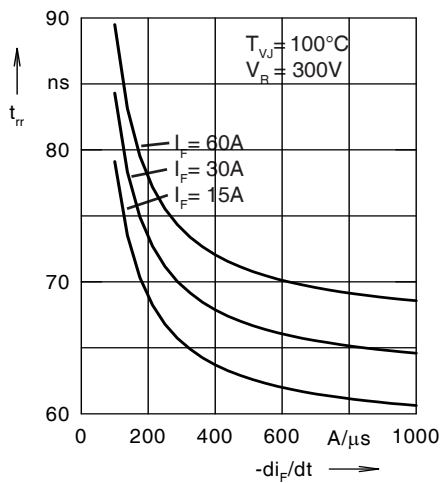

Fig. 18. Recovery time t_{rr} versus $-di_F/dt$

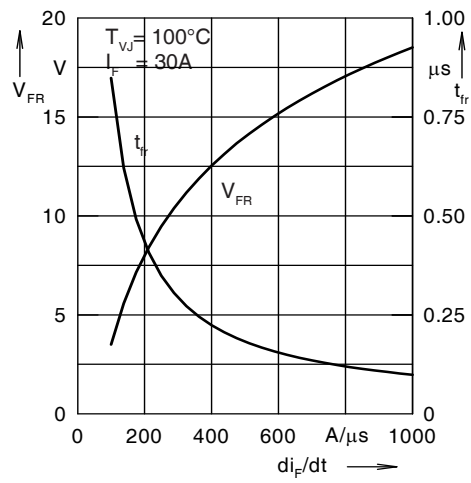

Fig. 19. Peak forward voltage V_{FR} and t_{rr} versus di_F/dt

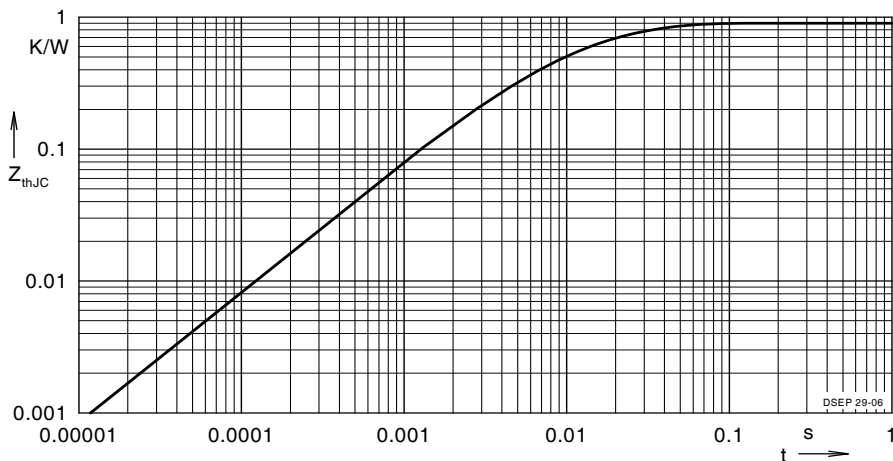

Fig. 20. Transient thermal resistance junction to case

Constants for Z_{thJC} calculation:

i	R_{thi} (K/W)	t_i (s)
1	0.502	0.0052
2	0.193	0.0003
3	0.205	0.0162