

**GenX3™ 1200V IGBTs
w/ Diode**
**IXGK50N120C3H1
IXGX50N120C3H1**
**High-Speed PT IGBTs
for 20 - 50 kHz Switching**

$$\begin{aligned} V_{CES} &= 1200V \\ I_{C100} &= 50A \\ V_{CE(sat)} &\leq 4.2V \\ t_{fi(typ)} &= 64ns \end{aligned}$$

TO-264 (IXGK)

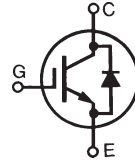
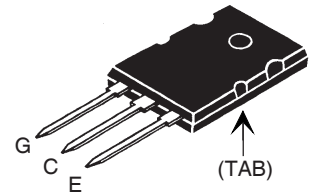

PLUS247™ (IXGX)

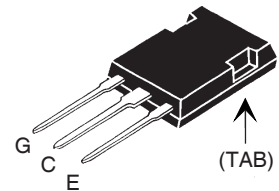

G = Gate E = Emitter
C = Collector TAB = Collector

Symbol	Test Conditions	Maximum Ratings	
V_{CES}	$T_J = 25^\circ\text{C to } 150^\circ\text{C}$	1200	V
V_{CGR}	$T_J = 25^\circ\text{C to } 150^\circ\text{C}, R_{GE} = 1M\Omega$	1200	V
V_{GES}	Continuous	± 20	V
V_{GEM}	Transient	± 30	V
I_{C25}	$T_C = 25^\circ\text{C}$ (Chip Capability)	95	A
I_{C100}	$T_C = 100^\circ\text{C}$	50	A
I_{CM}	$T_C = 25^\circ\text{C}, 1\text{ms}$	240	A
I_A	$T_C = 25^\circ\text{C}$	40	A
E_{AS}	$T_C = 25^\circ\text{C}$	750	mJ
SSOA (RBSOA)	$V_{GE} = 15V, T_J = 125^\circ\text{C}, R_G = 3\Omega$ Clamped Inductive Load	$I_{CM} = 100$ $V_{CE} \leq V_{CES}$	A
P_C	$T_C = 25^\circ\text{C}$	460	W
T_J		-55 ... +150	$^\circ\text{C}$
T_{JM}		150	$^\circ\text{C}$
T_{stg}		-55 ... +150	$^\circ\text{C}$
T_L	Maximum Lead Temperature for Soldering	300	$^\circ\text{C}$
T_{SOLD}	1.6 mm (0.062 in.) from Case for 10	260	$^\circ\text{C}$
M_d	Mounting Torque (IXGK)	1.13/10	Nm/lb.in.
F_C	Mounting Force (IXGX)	20..120/4.5..14.6	N/lb.
Weight	TO-264	10	g
	PLUS247	6	g

Symbol	Test Conditions ($T_J = 25^\circ\text{C}$, Unless Otherwise Specified)	Characteristic Values		
		Min.	Typ.	Max.
$V_{GE(th)}$	$I_C = 250\mu\text{A}, V_{CE} = V_{GE}$	3.0		5.0 V
I_{CES}	$V_{CE} = V_{CES}, V_{GE} = 0V$ $T_J = 125^\circ\text{C}, \text{Note 1}$			250 μA 14 mA
I_{GES}	$V_{CE} = 0V, V_{GE} = \pm 20V$			± 100 nA
$V_{CE(sat)}$	$I_C = 40A, V_{GE} = 15V, \text{Note 2}$ $T_J = 125^\circ\text{C}$		2.6	4.2 V

Features

- Optimized for Low Switching Losses
- Square RBSOA
- High Avalanche Capability
- Anti-Parallel Ultra Fast Diode
- International Standard Packages

Advantages

- High Power Density
- Low Gate Drive Requirement

Applications

- High Frequency Power Inverters
- UPS
- Motor Drives
- SMPS
- PFC Circuits
- Battery Chargers
- Welding Machines
- Lamp Ballasts

Symbol	Test Conditions ($T_J = 25^\circ\text{C}$, Unless Otherwise Specified)	Characteristic Values		
		Min.	Typ.	Max.
g_{fs}	$I_C = 40\text{A}$, $V_{CE} = 10\text{V}$, Note 2	24	40	S
C_{ies}	$V_{CE} = 25\text{V}$, $V_{GE} = 0\text{V}$, $f = 1\text{MHz}$		4250	pF
C_{oes}			455	pF
C_{res}			120	pF
Q_g	$I_C = 50\text{A}$, $V_{GE} = 15\text{V}$, $V_{CE} = 0.5 \cdot V_{CES}$		196	nC
Q_{ge}			24	nC
Q_{gc}			84	nC
$t_{d(on)}$	Inductive load, $T_J = 25^\circ\text{C}$ $I_C = 40\text{A}$, $V_{GE} = 15\text{V}$ $V_{CE} = 0.5 \cdot V_{CES}$, $R_G = 2\Omega$ Note 3		31	ns
t_{ri}			36	ns
E_{on}			2.0	mJ
$t_{d(off)}$			123	ns
t_{fi}			64	ns
E_{off}			0.63	1.2 mJ
$t_{d(on)}$	Inductive load, $T_J = 125^\circ\text{C}$ $I_C = 40\text{A}$, $V_{GE} = 15\text{V}$ $V_{CE} = 0.5 \cdot V_{CES}$, $R_G = 2\Omega$ Note 3		23	ns
t_{ri}			37	ns
E_{on}			3.0	mJ
$t_{d(off)}$			170	ns
t_{fi}			315	ns
E_{off}			2.1	mJ
R_{thJC}				0.27 $^\circ\text{C/W}$
R_{thCK}		0.15		$^\circ\text{C/W}$

Reverse Diode (FRED)

Symbol	Test Conditions ($T_J = 25^\circ\text{C}$, Unless Otherwise Specified)	Characteristic Values		
		Min.	Typ.	Max.
V_F	$I_F = 50\text{A}$, $V_{GE} = 0\text{V}$, Note 1 $T_J = 125^\circ\text{C}$		2.1	2.4 V 2.3 V
I_{RM}	$I_F = 50\text{A}$, $V_{GE} = 0\text{V}$, $-di_F/dt = 2500\text{A}/\mu\text{s}$, $V_R = 800\text{V}$		50	A
t_{rr}			75	ns
R_{thJC}				0.30 $^\circ\text{C/W}$

Notes:

- Part must be heatsunk for high-temp I_{CES} measurement.
- Pulse test, $t \leq 300\mu\text{s}$, duty cycle, $d \leq 2\%$.
- Switching times & energy losses may increase for higher V_{CE} (Clamp), T_J or R_G .

ADVANCE TECHNICAL INFORMATION

The product presented herein is under development. The Technical Specifications offered are derived from a subjective evaluation of the design, based upon prior knowledge and experience, and constitute a "considered reflection" of the anticipated result. IXYS reserves the right to change limits, test conditions, and dimensions without notice.

IXYS Reserves the Right to Change Limits, Test Conditions, and Dimensions.

IXYS MOSFETs and IGBTs are covered by one or more of the following U.S. patents:	4,835,592	4,931,844	5,049,961	5,237,481	6,162,665	6,404,065 B1	6,683,344	6,727,585	7,005,734 B2	7,157,338B2
	4,850,072	5,017,508	5,063,307	5,381,025	6,259,123 B1	6,534,343	6,710,405 B2	6,759,692	7,063,975 B2	
	4,881,106	5,034,796	5,187,117	5,486,715	6,306,728 B1	6,583,505	6,710,463	6,771,478 B2	7,071,537	

TO-264 (IXGK) Outline

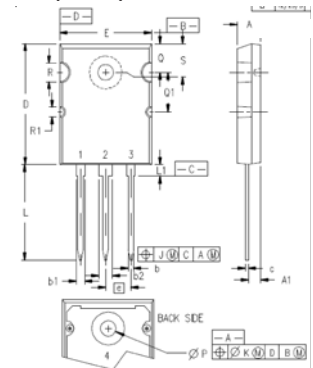

1 - GATE
2, 4 - DRAIN (COLLECTOR)
3 - SOURCE (EMITTER)

SYM	INCHES		MILLIMETERS	
	MIN	MAX	MIN	MAX
A	.185	.209	4.70	5.31
A1	.102	.118	2.59	3.00
b	.037	.055	0.94	1.40
b1	.087	.102	2.21	2.59
b2	.110	.126	2.79	3.20
c	.017	.029	0.43	0.74
D	1.007	1.047	25.58	26.59
E	.760	.799	19.30	20.29
e	.215 BSC		5.46 BSC	
J	.000	.010	0.00	0.25
K	.000	.010	0.00	0.25
L	.779	.842	19.79	21.39
L1	.087	.102	2.21	2.59
ØP	.122	.138	3.10	3.51
Q	.240	.256	6.10	6.50
Q1	.330	.346	8.38	8.79
ØR	.155	.187	3.94	4.75
ØR1	.085	.093	2.16	2.36
S	.243	.253	6.17	6.43

PLUS247™ (IXGX) Outline

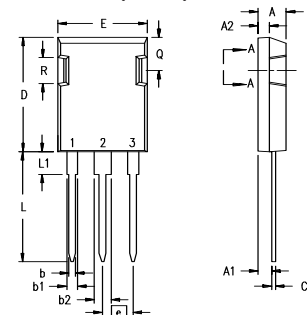

Terminals: 1 - Gate
2 - Drain (Collector)
3 - Source (Emitter)

Dim.	Millimeter		Inches	
	Min.	Max.	Min.	Max.
A	4.83	5.21	.190	.205
A ₁	2.29	2.54	.090	.100
A ₂	1.91	2.16	.075	.085
b	1.14	1.40	.045	.055
b ₁	1.91	2.13	.075	.084
b ₂	2.92	3.12	.115	.123
C	0.61	0.80	.024	.031
D	20.80	21.34	.819	.840
E	15.75	16.13	.620	.635
e	5.45 BSC		.215 BSC	
L	19.81	20.32	.780	.800
L1	3.81	4.32	.150	.170
Q	5.59	6.20	.220	0.244
R	4.32	4.83	.170	.190

Fig. 1. Output Characteristics @ 25°C

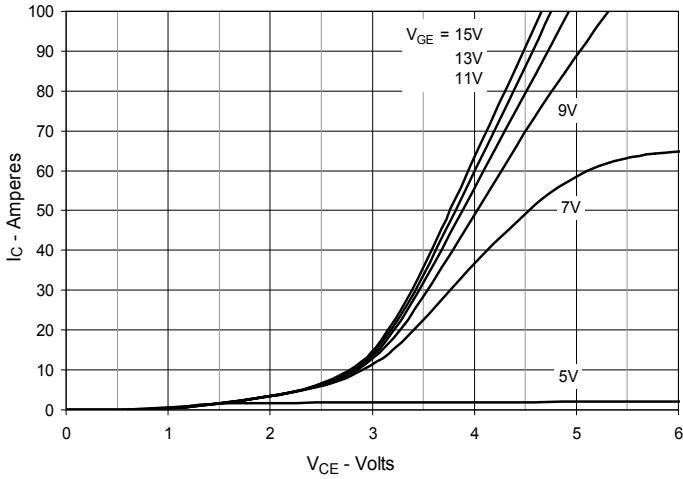

Fig. 2. Extended Output Characteristics @ 25°C

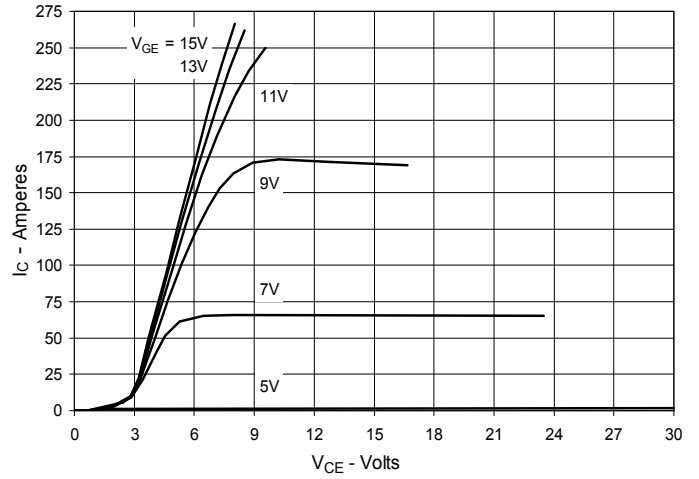

Fig. 3. Output Characteristics @ 125°C

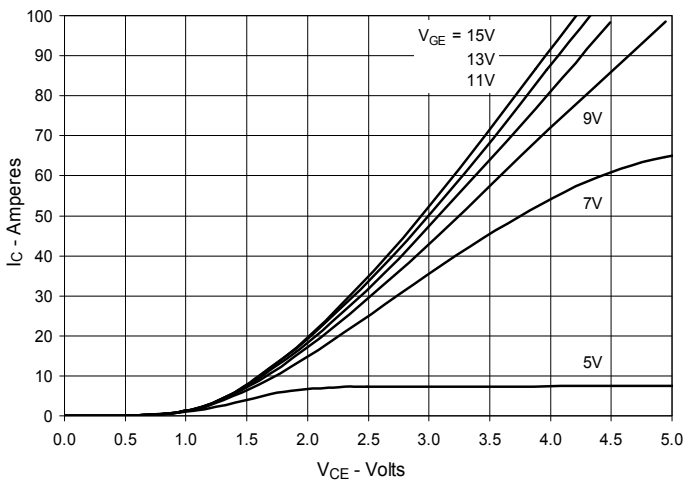

Fig. 4. Dependence of VCE(sat) on Junction Temperature

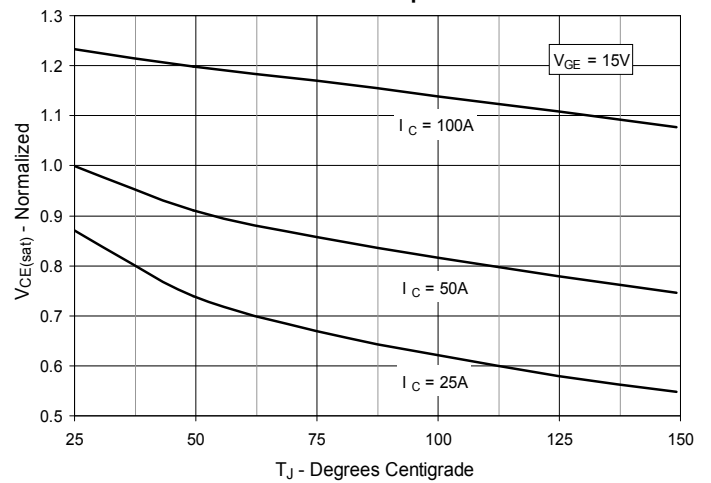

Fig. 5. Collector-to-Emitter Voltage vs. Gate-to-Emitter Voltage

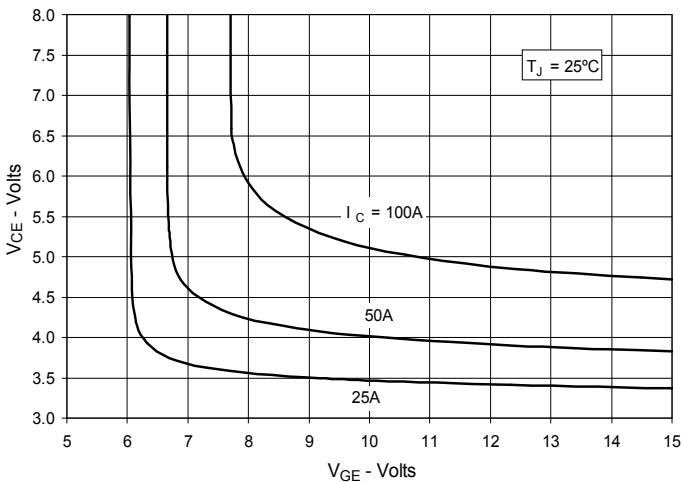

Fig. 6. Input Admittance

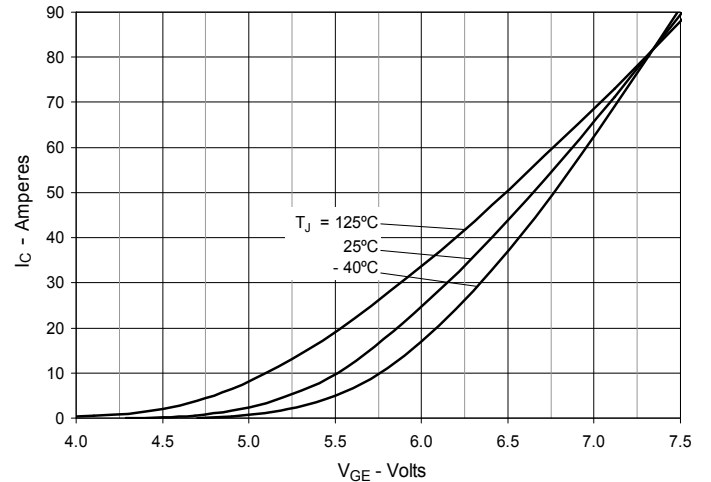

Fig. 7. Transconductance

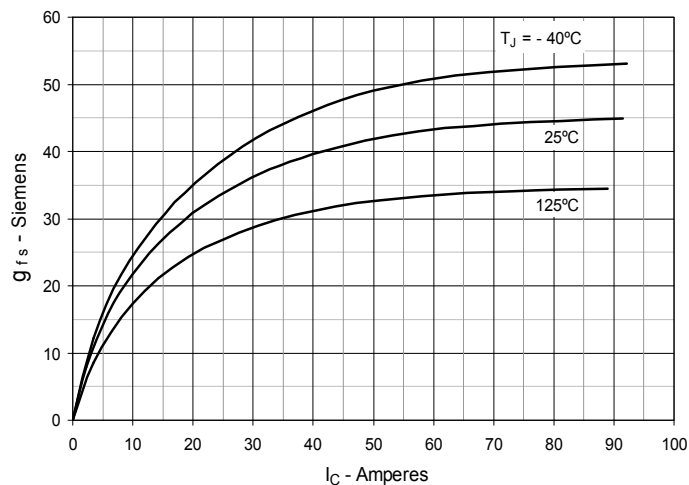

Fig. 8. Gate Charge

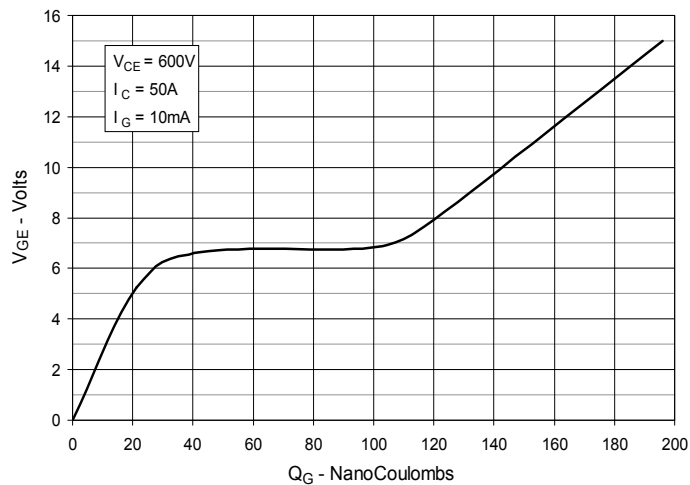

Fig. 9. Capacitance

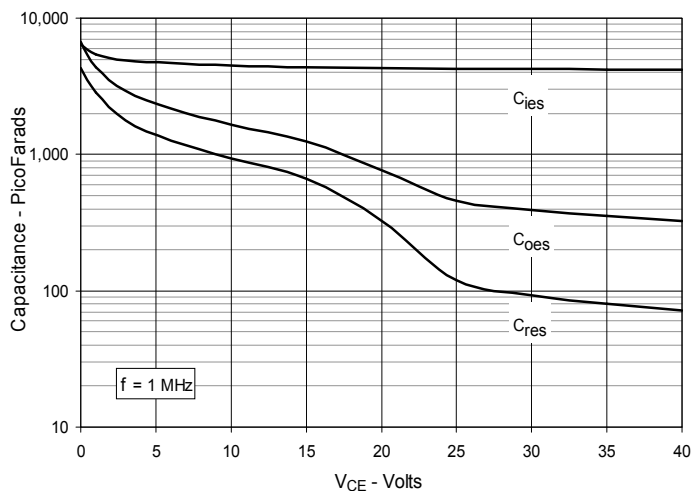

Fig. 10. Reverse-Bias Safe Operating Area

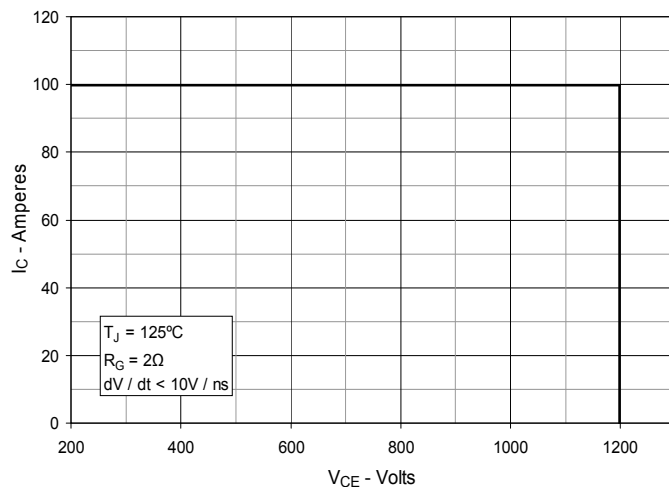
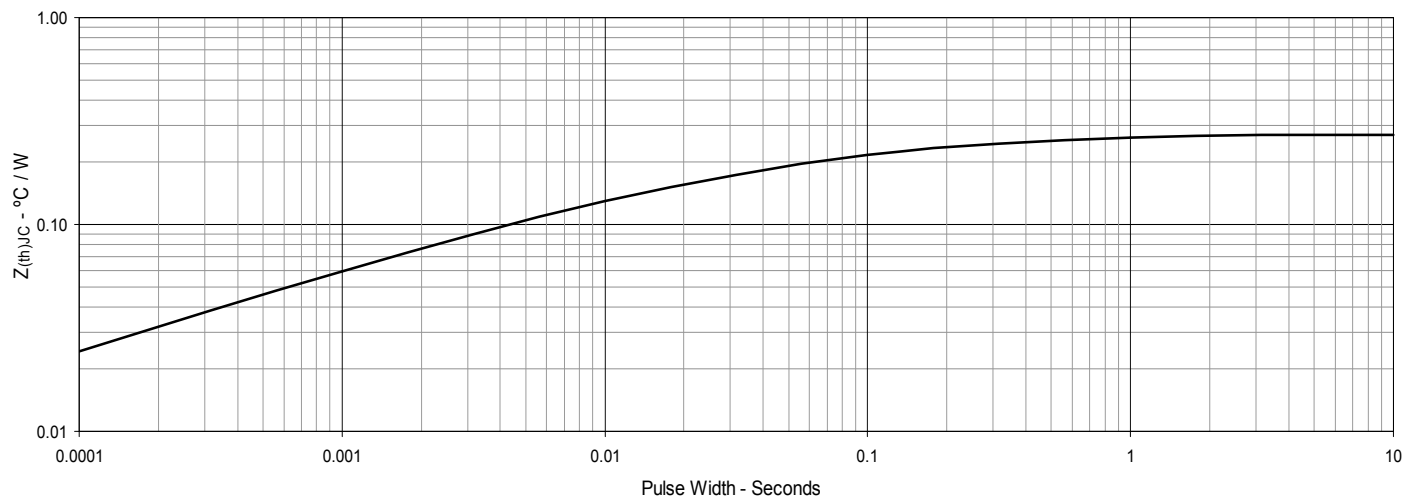
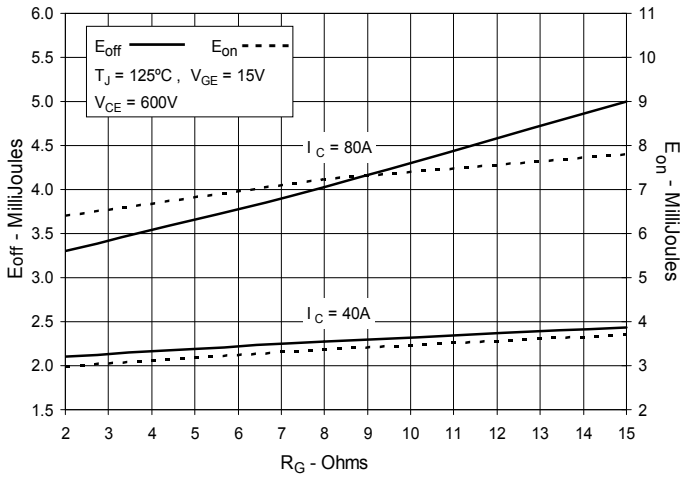

Fig. 11. Maximum Transient Thermal Impedance



**Fig. 12. Inductive Switching
Energy Loss vs. Gate Resistance**



**Fig. 13. Inductive Switching
Energy Loss vs. Collector Current**

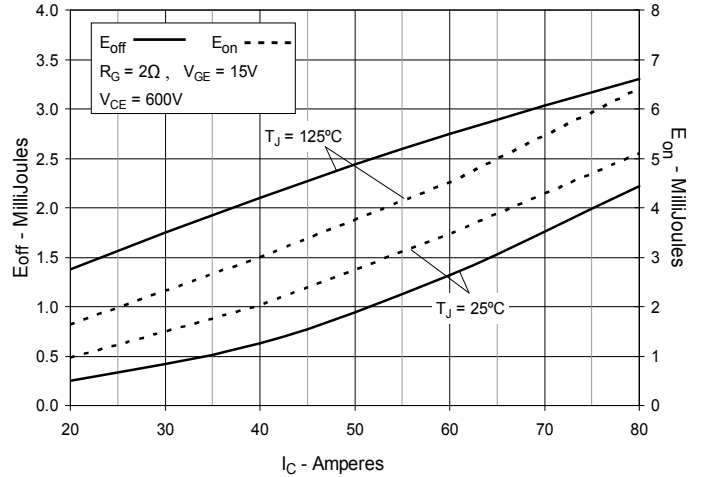

**Fig. 14. Inductive Switching
Energy Loss vs. Junction Temperature**

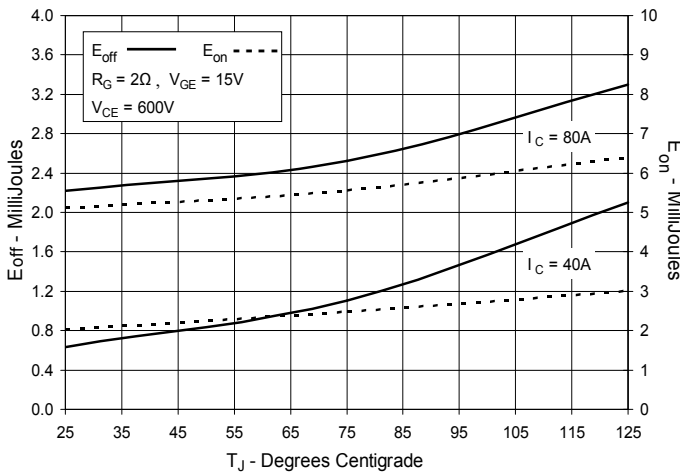

**Fig. 15. Inductive Turn-off
Switching Times vs. Gate Resistance**

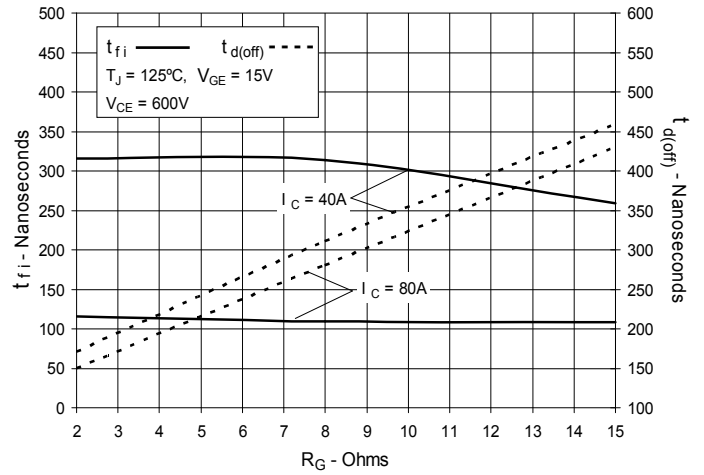

**Fig. 16. Inductive Turn-off
Switching Times vs. Collector Current**

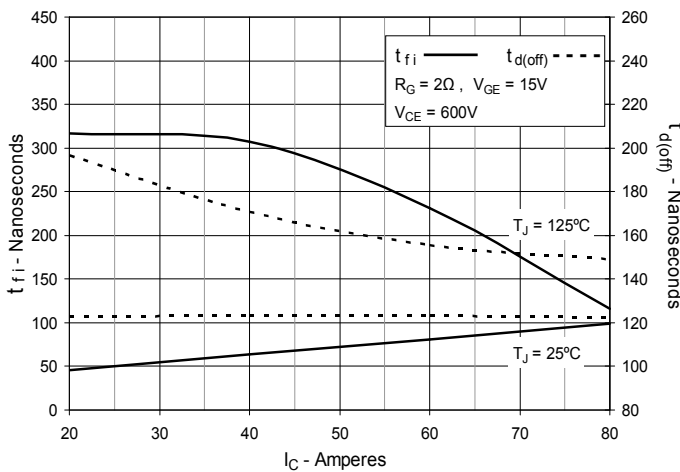

**Fig. 17. Inductive Turn-off
Switching Times vs. Junction Temperature**

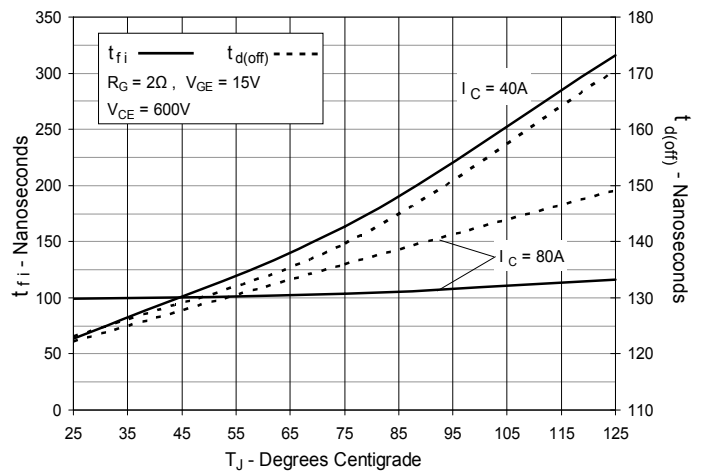

**Fig. 18. Inductive Turn-on
Switching Times vs. Gate Resistance**

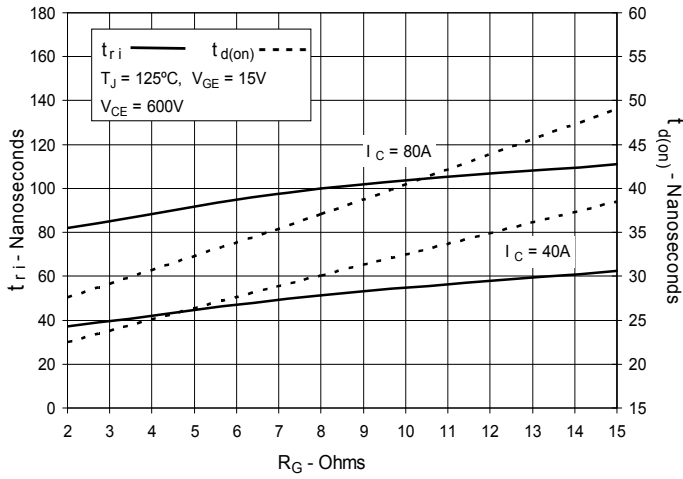

**Fig. 19. Inductive Turn-on
Switching Times vs. Collector Current**

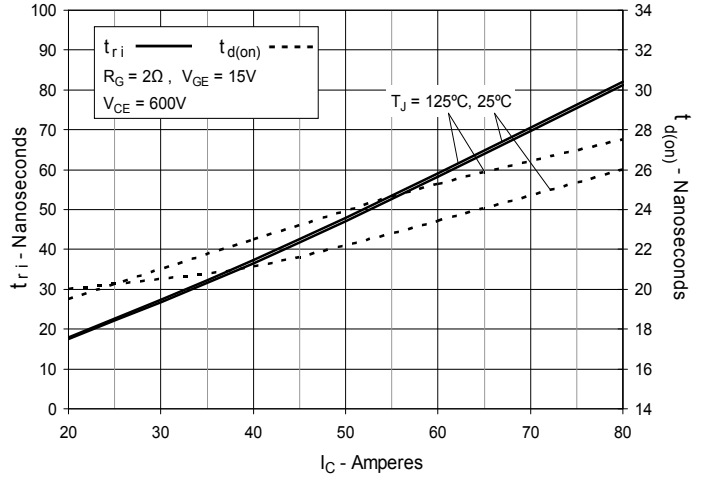

**Fig. 20. Inductive Turn-on
Switching Times vs. Junction Temperature**

