

# HiPerFAST™ IGBT with Diode B2-Class High Speed IGBTs

**IXGK 50N60B2D1**  
**IXGX 50N60B2D1**

$V_{CES} = 600 \text{ V}$   
 $I_{C25} = 75 \text{ A}$   
 $V_{CE(sat)} = 2.0 \text{ V}$   
 $t_{fi(typ)} = 65 \text{ ns}$

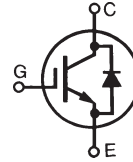

Symbol	Test Conditions	Maximum Ratings	
$V_{CES}$	$T_J = 25^\circ\text{C to } 150^\circ\text{C}$	600	V
$V_{CGR}$	$T_J = 25^\circ\text{C to } 150^\circ\text{C}; R_{GE} = 1 \text{ M}\Omega$	600	V
$V_{GES}$	Continuous	$\pm 20$	V
$V_{GEM}$	Transient	$\pm 30$	V
$I_{C25}$	$T_C = 25^\circ\text{C}$ (limited by leads)	75	A
$I_{C110}$	$T_C = 110^\circ\text{C}$	50	A
$I_{F110}$	$T_C = 110^\circ\text{C}$ (50N60B2D1 Diode)	38	A
$I_{CM}$	$T_C = 25^\circ\text{C}, 1 \text{ ms}$	200	A
<b>SSOA</b> <b>(RBSOA)</b>	$V_{GE} = 15 \text{ V}, T_{VJ} = 125^\circ\text{C}, R_G = 10 \Omega$ Clamped inductive load @ $V_{CE} \leq 600 \text{ V}$	$I_{CM} = 80$	A
$P_c$	$T_C = 25^\circ\text{C}$	400	W
$T_J$		-55 ... +150	$^\circ\text{C}$
$T_{JM}$		150	$^\circ\text{C}$
$T_{stg}$		-55 ... +150	$^\circ\text{C}$
$M_d$	Mounting torque, TO-264	1.13/10	Nm/lb.in.
<b>Weight</b>	TO-264	10	g
	PLUS247	6	g
Maximum lead temperature for soldering 1.6 mm (0.062 in.) from case for 10 s		300	$^\circ\text{C}$

**TO-264**  
**(IXGK)**

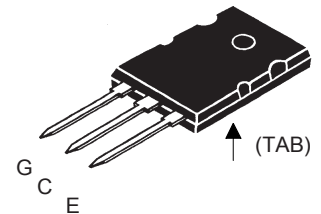

**PLUS247**  
**(IXGX)**

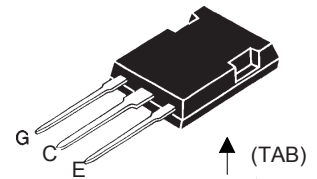

G = Gate      C = Collector  
E = Emitter    Tab = Collector

## Features

- High frequency IGBT and anti-parallel FRED in one package
- High current handling capability
- MOS Gate turn-on for drive simplicity
- Fast Recovery Epitaxial Diode (FRED) with soft recovery and low  $I_{RM}$

## Applications

- Switch-mode and resonant-mode power supplies
- Uninterruptible power supplies (UPS)
- DC choppers
- AC motor speed control
- DC servo and robot drives

## Advantages

- Space savings (two devices in one package)
- Easy to mount with 1 screw

Symbol	Test Conditions	Characteristic Values ( $T_J = 25^\circ\text{C}$ , unless otherwise specified)		
		Min.	Typ.	Max.
$V_{GE(th)}$	$I_C = 250 \mu\text{A}, V_{CE} = V_{GE}$	3.0		5.0 V
$I_{CES}$	$V_{CE} = V_{CES}$ $V_{GE} = 0 \text{ V}$	$T_J = 25^\circ\text{C}$ $T_J = 125^\circ\text{C}$		600 $\mu\text{A}$
				5 mA
$I_{GES}$	$V_{CE} = 0 \text{ V}, V_{GE} = \pm 20 \text{ V}$			$\pm 100 \text{ nA}$
$V_{CE(sat)}$	$I_C = 40 \text{ A}, V_{GE} = 15 \text{ V}$ Note 1	$T_J = 125^\circ\text{C}$	1.6	2.0 V
			1.5	V

Symbol	Test Conditions	Characteristic Values ( $T_J = 25^\circ\text{C}$ , unless otherwise specified)			
		Min.	Typ.	Max.	
$g_{fs}$	$I_C = 40\text{ A}; V_{CE} = 10\text{ V}$ , Note 1	40	55	S	
$C_{ies}$	$V_{CE} = 25\text{ V}, V_{GE} = 0\text{ V}, f = 1\text{ MHz}$		3500	pF	
$C_{oes}$			220	pF	
$C_{res}$			50	pF	
$Q_g$	$I_C = 40\text{ A}, V_{GE} = 15\text{ V}, V_{CE} = 0.5 V_{CES}$		140	nC	
$Q_{ge}$			23	nC	
$Q_{gc}$			44	nC	
$t_{d(on)}$	<b>Inductive load, <math>T_J = 25^\circ\text{C}</math></b> $I_C = 40\text{ A}, V_{GE} = 15\text{ V}$ $V_{CE} = 480\text{ V}, R_G = R_{off} = 5.0\ \Omega$		18	ns	
$t_{ri}$			25	ns	
$t_{d(off)}$			190	300	ns
$t_{fi}$			65	ns	
$E_{off}$			0.55	0.85	mJ
$t_{d(on)}$	<b>Inductive load, <math>T_J = 125^\circ\text{C}</math></b> $I_C = 40\text{ A}, V_{GE} = 15\text{ V}$ $V_{CE} = 480\text{ V}, R_G = R_{off} = 5.0\ \Omega$		18	ns	
$t_{ri}$			25	ns	
$E_{on}$			0.9	mJ	
$t_{d(off)}$			290	ns	
$t_{fi}$			140	ns	
$E_{off}$		1.55	mJ		
$R_{thJC}$			0.31	K/W	
$R_{thCK}$		0.15		K/W	

**Reverse Diode (FRED)**

Symbol	Test Conditions	Characteristic Values ( $T_J = 25^\circ\text{C}$ , unless otherwise specified)		
		min.	typ.	max.
$V_F$	$I_F = 60\text{ A}, V_{GE} = 0\text{ V}$ , Note 1			2.1 V
		$T_J = 150^\circ\text{C}$		1.4
$I_{RM}$	$I_F = 60\text{ A}, V_{GE} = 0\text{ V}, -di_F/dt = 100\text{ A}/\mu\text{s}$ $T_J = 100^\circ\text{C}$ $V_R = 100\text{ V}$			8.3 A
$t_{rr}$	$I_F = 1\text{ A}; -di/dt = 200\text{ A/ms}; V_R = 30\text{ V}$		35	ns
$R_{thJC}$				0.65 K/W

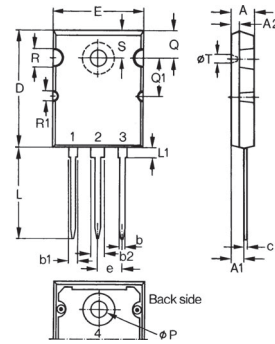
 Note 1: Pulse test,  $t \leq 300\ \mu\text{s}$ , duty cycle  $\leq 2\%$ 
**TO-264 Outline**

Dim.	Millimeter		Inches	
	Min.	Max.	Min.	Max.
A	4.82	5.13	.190	.202
A1	2.54	2.89	.100	.114
A2	2.00	2.10	.079	.083
b	1.12	1.42	.044	.056
b1	2.39	2.69	.094	.106
b2	2.90	3.09	.114	.122
c	0.53	0.83	.021	.033
D	25.91	26.16	1.020	1.030
E	19.81	19.96	.780	.786
e	5.46 BSC		.215 BSC	
J	0.00	0.25	.000	.010
K	0.00	0.25	.000	.010
L	20.32	20.83	.800	.820
L1	2.29	2.59	.090	.102
P	3.17	3.66	.125	.144
Q	6.07	6.27	.239	.247
Q1	8.38	8.69	.330	.342
R	3.81	4.32	.150	.170
R1	1.78	2.29	.070	.090
S	6.04	6.30	.238	.248
T	1.57	1.83	.062	.072

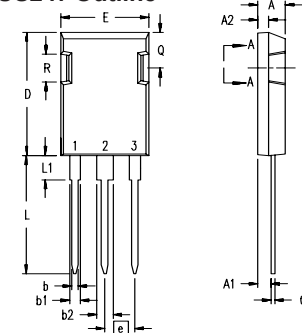
**PLUS247 Outline**

 Terminals: 1 - Gate  
 2 - Drain (Collector)  
 3 - Source (Emitter)  
 4 - Drain (Collector)

Dim.	Millimeter		Inches	
	Min.	Max.	Min.	Max.
A	4.83	5.21	.190	.205
A <sub>1</sub>	2.29	2.54	.090	.100
A <sub>2</sub>	1.91	2.16	.075	.085
b	1.14	1.40	.045	.055
b <sub>1</sub>	1.91	2.13	.075	.084
b <sub>2</sub>	2.92	3.12	.115	.123
C	0.61	0.80	.024	.031
D	20.80	21.34	.819	.840
E	15.75	16.13	.620	.635
e	5.45 BSC		.215 BSC	
L	19.81	20.32	.780	.800
L1	3.81	4.32	.150	.170
Q	5.59	6.20	.220	0.244
R	4.32	4.83	.170	.190

IXYS reserves the right to change limits, test conditions, and dimensions.

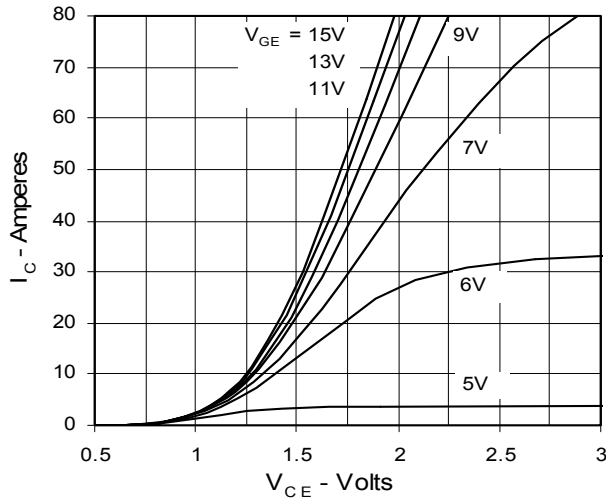
**Fig. 1. Output Characteristics  
@ 25 Deg. C**



**Fig. 2. Extended Output Characteristics  
@ 25 deg. C**

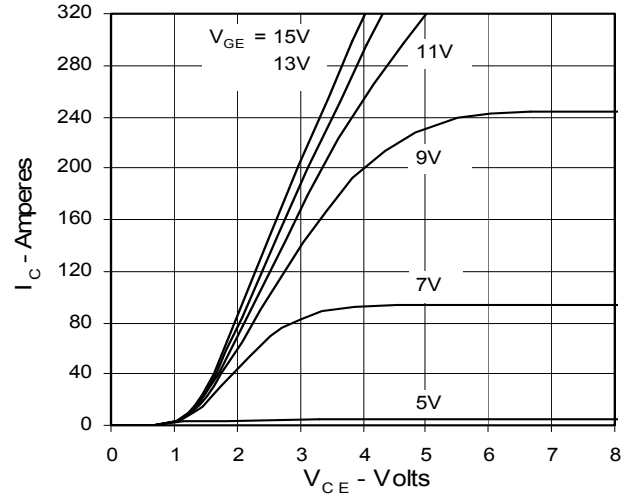

**Fig. 3. Output Characteristics  
@ 125 Deg. C**

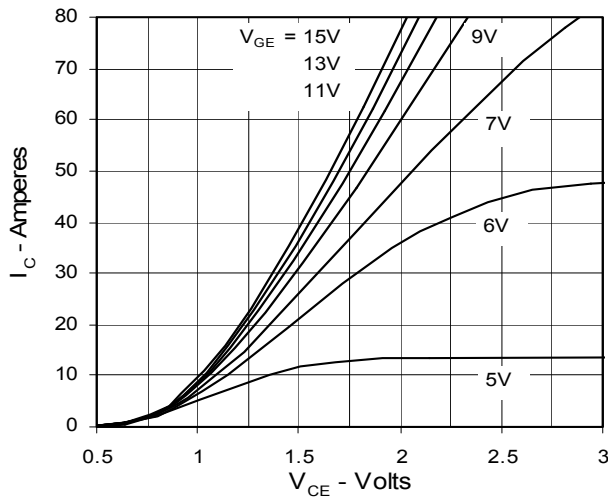

**Fig. 4. Dependence of  $V_{CE(sat)}$  on  
Temperature**

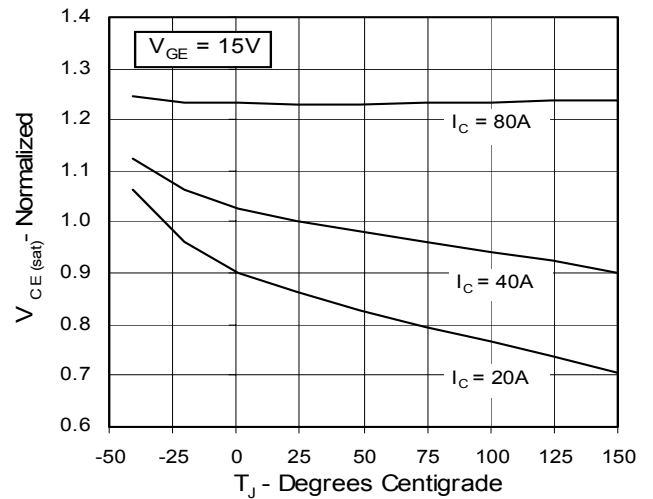

**Fig. 5. Collector-to-Emitter Voltage  
vs. Gate-to-Emitter voltage**

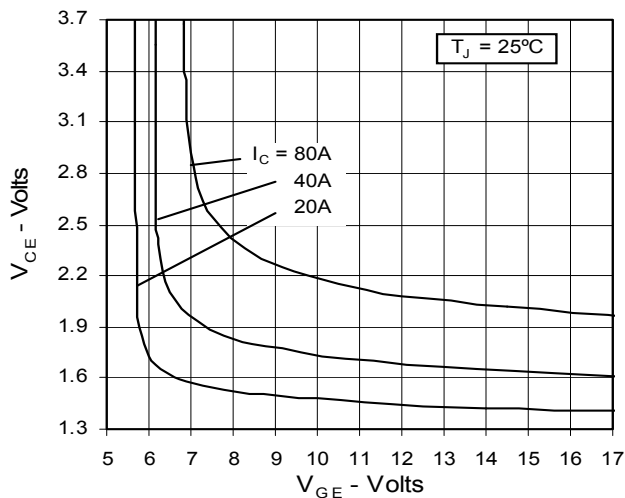

**Fig. 6. Input Admittance**

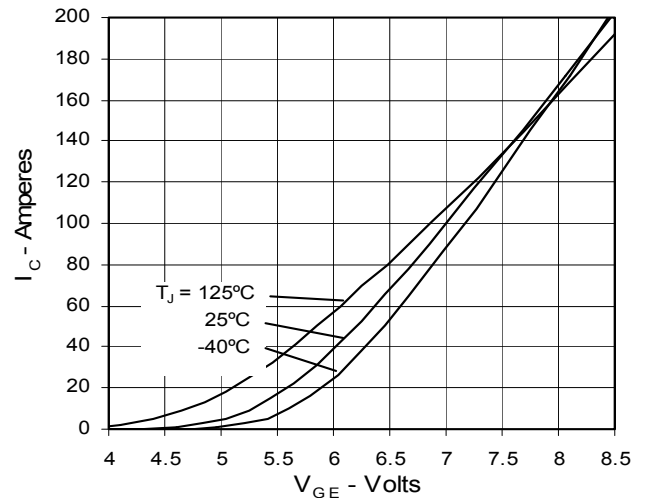

Fig. 7. Transconductance

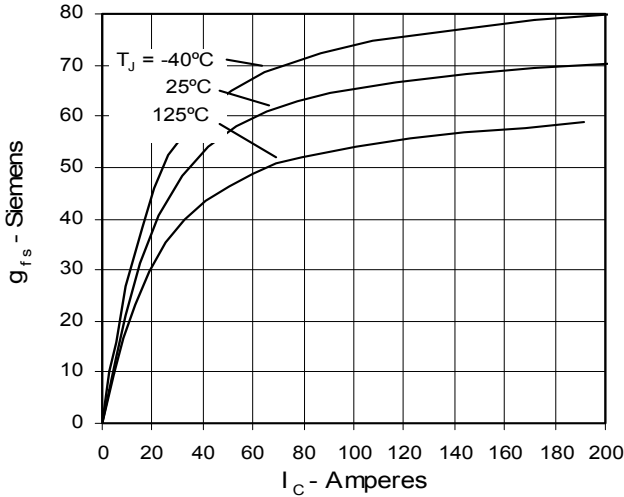

Fig. 8. Dependence of Turn-Off Energy on  $R_G$

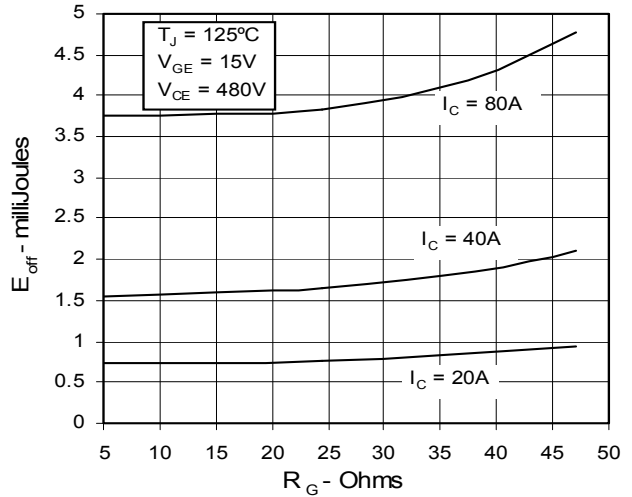

Fig. 9. Dependence of Turn-Off Energy on  $I_C$

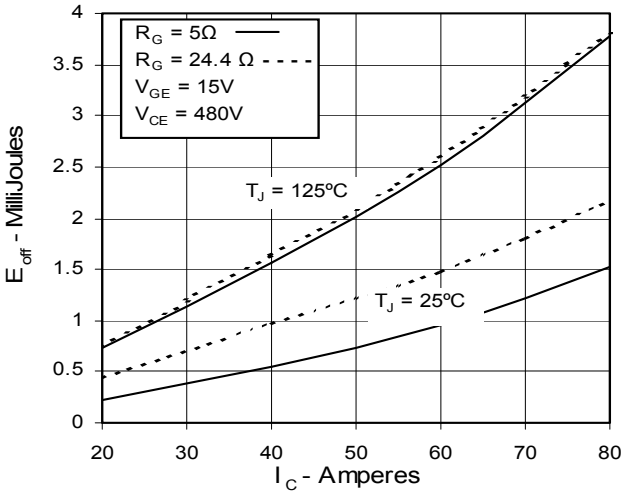

Fig. 10. Dependence of Turn-Off Energy on Temperature

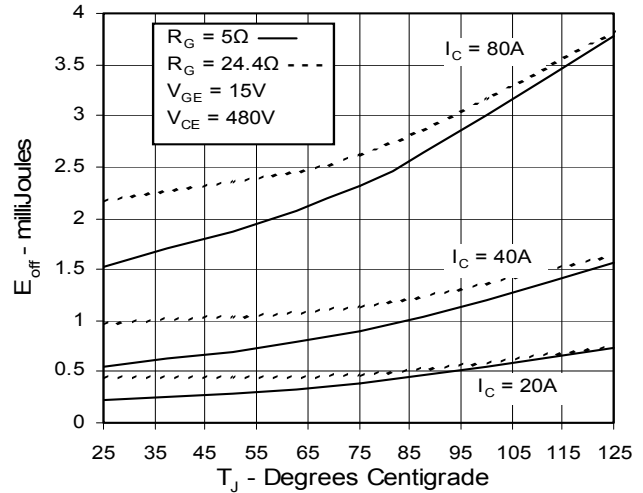

Fig. 11. Dependence of Turn-Off Switching Time on  $R_G$

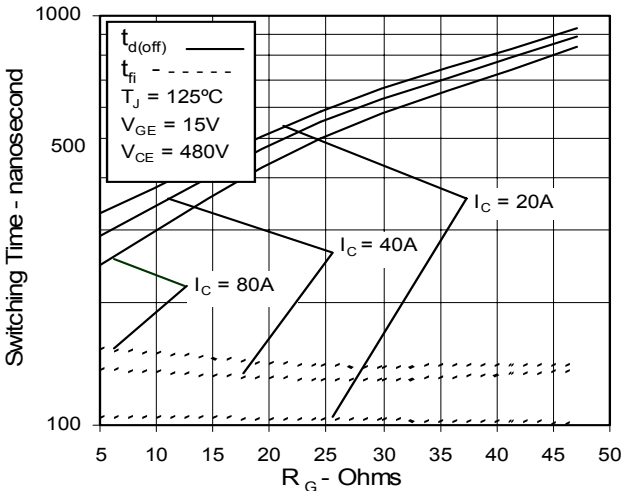
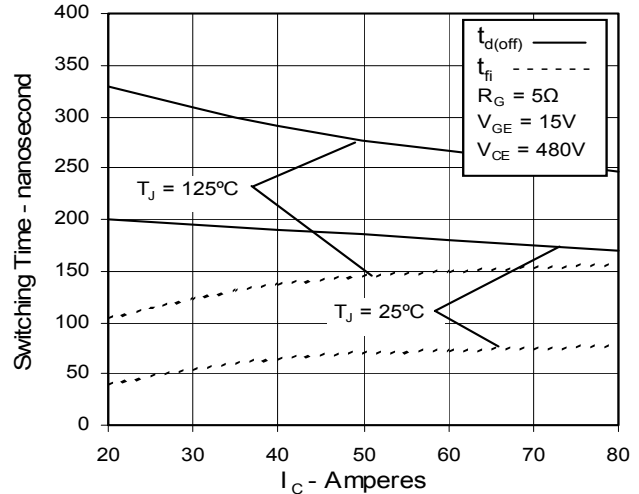
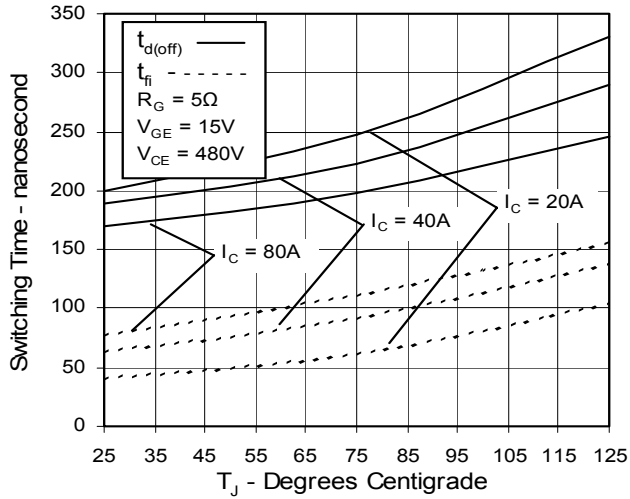

Fig. 12. Dependence of Turn-Off Switching Time on  $I_C$



IXYS reserves the right to change limits, test conditions, and dimensions.

**Fig. 13. Dependence of Turn-Off Switching Time on Temperature**



**Fig. 14. Reverse-Bias Safe Operating Area**

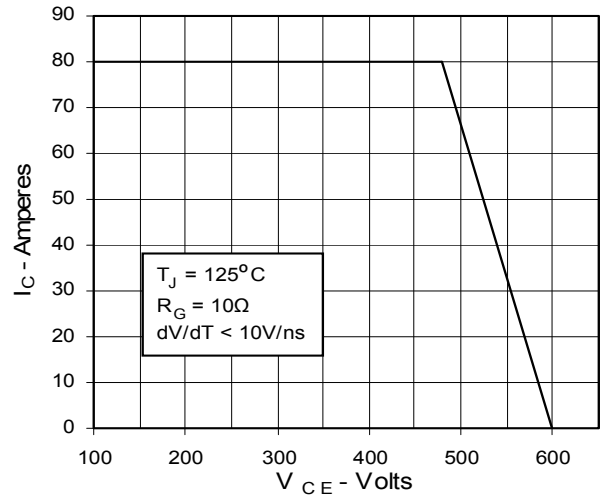

**Fig. 15. Gate Charge**

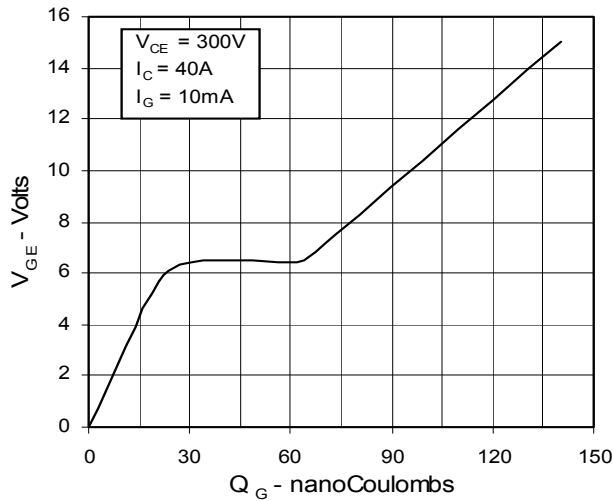

**Fig. 16. Capacitance**

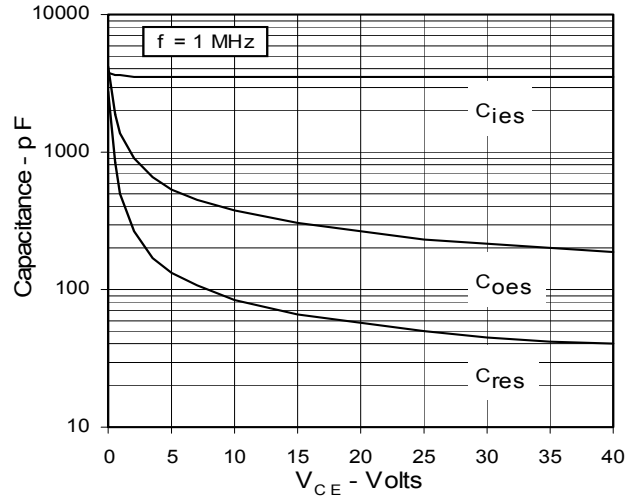

**Fig. 17. Maximum Transient Thermal Resistance**

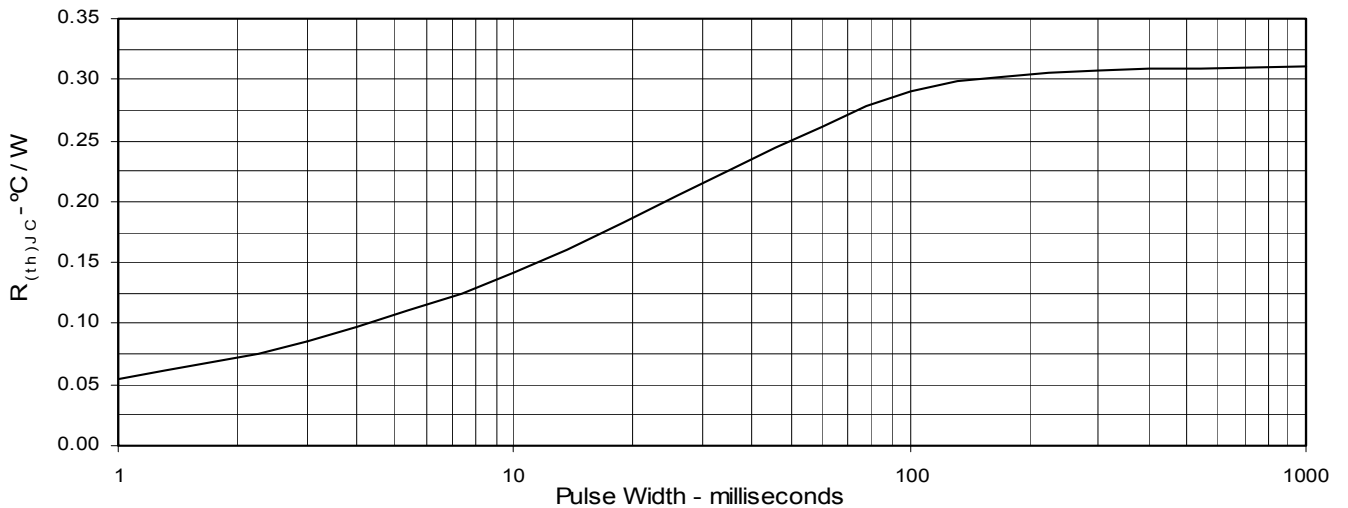

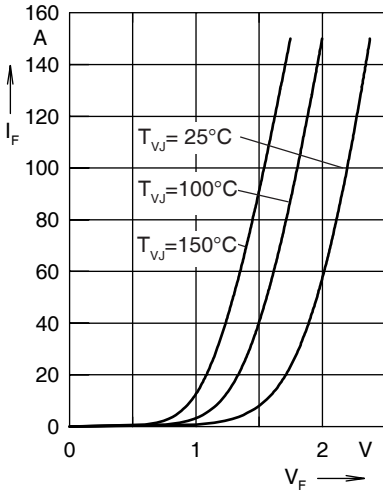

Fig. 18. Forward current  $I_F$  versus  $V_F$

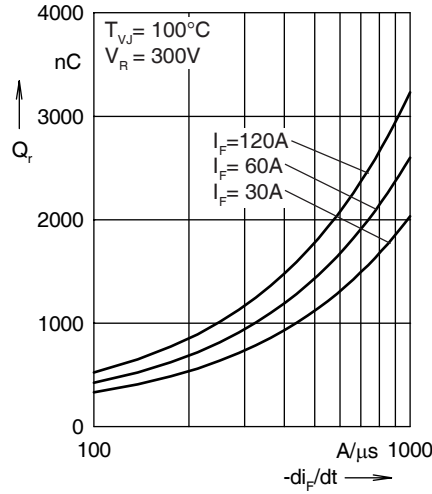

Fig. 19. Reverse recovery charge  $Q_r$  versus  $-di_F/dt$

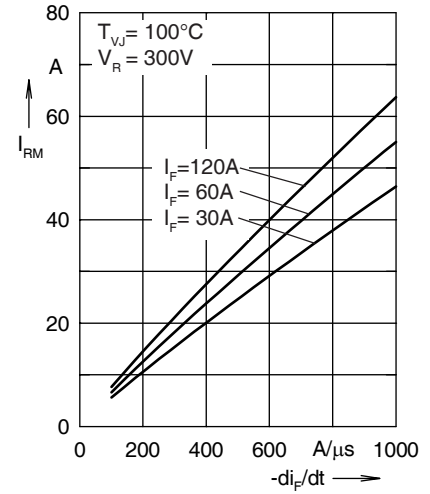

Fig. 20. Peak reverse current  $I_{RM}$  versus  $-di_F/dt$

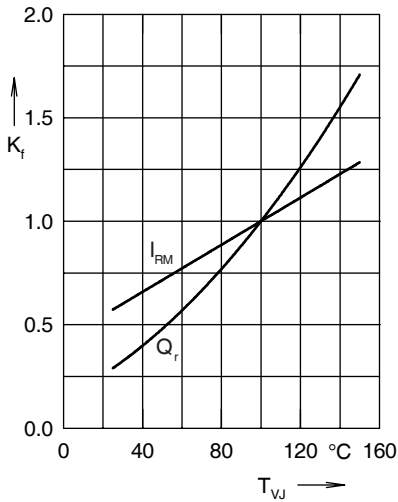

Fig. 21. Dynamic parameters  $Q_r$ ,  $I_{RM}$  versus  $T_{VJ}$

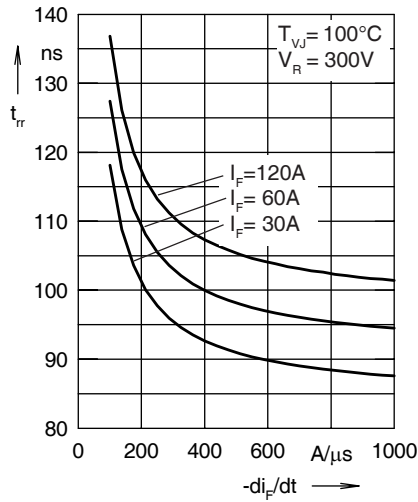

Fig. 22. Recovery time  $t_{rr}$  versus  $-di_F/dt$

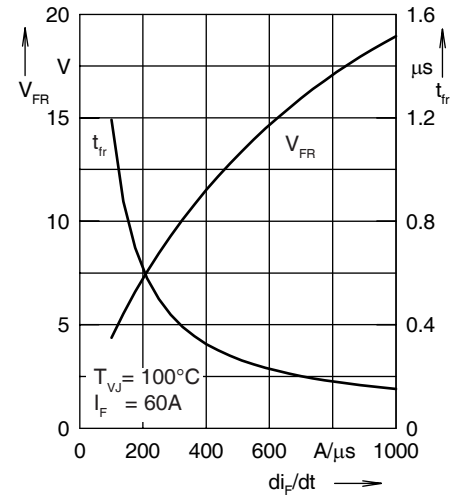

Fig. 23. Peak forward voltage  $V_{FR}$  and  $t_{fr}$  versus  $di_F/dt$

Constants for  $Z_{thJC}$  calculation:

i	$R_{thi}$ (K/W)	$t_i$ (s)
1	0.324	0.0052
2	0.125	0.0003
3	0.201	0.0385

Note: Fig. 18 through Fig. 23 show typical values

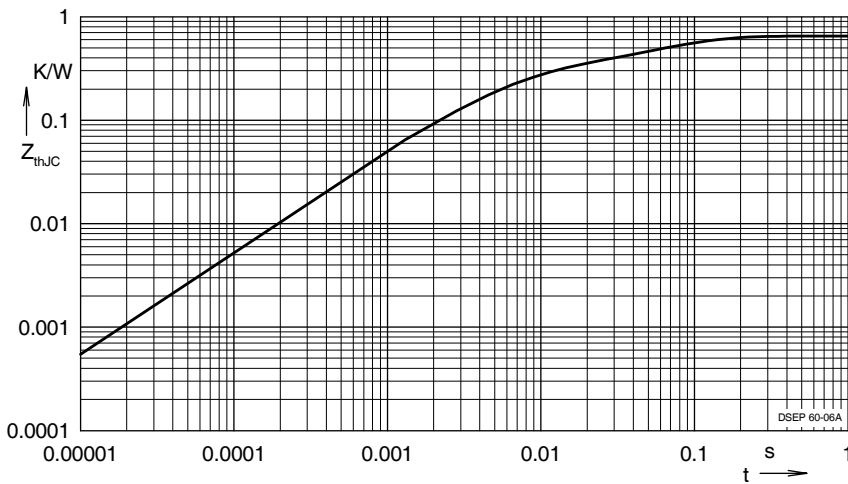

Fig. 24. Transient thermal resistance junction to case

IXYS reserves the right to change limits, test conditions, and dimensions.

IXYS MOSFETs and IGBTs are covered by one or more of the following U.S. patents:

4,850,072	4,931,844	5,034,796	5,063,307	5,237,481	5,381,025	6,404,065B1	6,162,665	6,534,343	6,583,505
4,835,592	4,881,106	5,017,508	5,049,961	5,187,117	5,486,715	6,306,728B1	6,259,123B1	6,306,728B1	6,683,344