

HiPerFAST™ IGBT

IXGA 12N60C
IXGP 12N60C

$V_{CES} = 600 \text{ V}$
 $I_{C25} = 24 \text{ A}$
 $V_{CE(sat)} = 2.7 \text{ V}$
 $t_{fi(typ)} = 55 \text{ ns}$

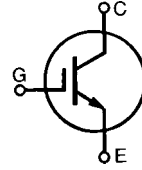

Symbol	Test Conditions	Maximum Ratings	
V_{CES}	$T_J = 25^\circ\text{C to } 150^\circ\text{C}$	600	V
V_{CGR}	$T_J = 25^\circ\text{C to } 150^\circ\text{C}; R_{GE} = 1 \text{ M}\Omega$	600	V
V_{GES}	Continuous	± 20	V
V_{GEM}	Transient	± 30	V
I_{C25}	$T_C = 25^\circ\text{C}$	24	A
I_{C90}	$T_C = 90^\circ\text{C}$	12	A
I_{CM}	$T_C = 25^\circ\text{C}, 1 \text{ ms}$	48	A
SSOA (RBSOA)	$V_{GE} = 15 \text{ V}, T_{VJ} = 125^\circ\text{C}, R_G = 33 \Omega$ Clamped inductive load, $L = 300 \mu\text{H}$	$I_{CM} = 24$ @ $0.8 V_{CES}$	A
P_C	$T_C = 25^\circ\text{C}$	100	W
T_J		-55 ... +150	$^\circ\text{C}$
T_{JM}		150	$^\circ\text{C}$
T_{stg}		-55 ... +150	$^\circ\text{C}$
M_d	Mounting torque with screw M3 Mounting torque with screw M3.5	0.45/4 0.55/5	Nm/lb.in.
Weight		4	g
	Maximum lead temperature for soldering 1.6 mm (0.062 in.) from case for 10 s	300	$^\circ\text{C}$

TO-263 AA (IXGA)

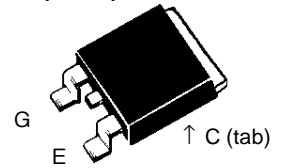

TO-220 AB (IXGP)

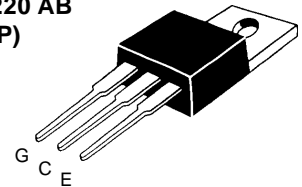

G = Gate C = Collector
E = Emitter TAB = Collector

Features

- Very high frequency IGBT
- New generation HDMOS™ process
- International standard package
JEDEC TO-220AB and TO-263AA
- High peak current handling capability

Applications

- PFC circuits
- AC motor speed control
- DC servo & robot drives
- Switch-mode and resonant-mode power supplies
- High power audio amplifiers

Advantages

- Fast switching speed
- High power density

Symbol	Test Conditions ($T_J = 25^\circ\text{C}$, unless otherwise specified)	Characteristic Values		
		Min.	Typ.	Max.
BV_{CES}	$I_C = 250 \mu\text{A}, V_{GE} = 0 \text{ V}$	600		V
$V_{GE(th)}$	$I_C = 250 \mu\text{A}, V_{GE} = V_{GE}$	2.5		V
I_{CES}	$V_{CE} = 0.8, V_{CES}$			200 μA
	$V_{GE} = 0 \text{ V}$	$T_J = 25^\circ\text{C}$		1 mA
I_{GES}	$V_{CE} = 0 \text{ V}, V_{GE} = \pm 20 \text{ V}$			$\pm 100 \text{ nA}$
$V_{CE(sat)}$	$I_C = I_{CE90}, V_{GE} = 15$	2.1	2.7	V

Symbol	Test Conditions ($T_J = 25^\circ\text{C}$, unless otherwise specified)	Characteristic Values		
		Min.	Typ.	Max.
g_{fs}	$I_C = I_{C90}$; $V_{CE} = 10\text{ V}$, Pulse test, $t \leq 300\ \mu\text{s}$, duty cycle $\leq 2\%$	7	11	S
C_{ies}	$V_{CE} = 25\text{ V}$, $V_{GE} = 0\text{ V}$, $f = 1\text{ MHz}$		860	pF
C_{oes}			64	pF
C_{res}			15	pF
Q_g	$I_C = I_{C90}$; $V_{GE} = 15\text{ V}$, $V_{CE} = 0.5 V_{CES}$		32	nC
Q_{ge}			10	nC
Q_{gc}			10	nC
$t_{d(on)}$	Inductive load, $T_J = 25^\circ\text{C}$ $I_C = I_{C90}$; $V_{GE} = 15\text{ V}$, $L = 300\ \mu\text{H}$ $V_{CE} = 0.8 V_{CES}$; $R_G = R_{off} = 18\ \Omega$ Remarks: Switching times may increase for V_{CE} (Clamp) $> 0.8 V_{CES}$, higher T_J or increased R_G		20	ns
t_{ri}			20	ns
$t_{d(off)}$			60	ns
t_{fi}			55	ns
E_{off}			0.09	mJ
$t_{d(on)}$	Inductive load, $T_J = 125^\circ\text{C}$ $I_C = I_{C90}$; $V_{GE} = 15\text{ V}$, $L = 300\ \mu\text{H}$ $V_{CE} = 0.8 V_{CES}$; $R_G = R_{off} = 18\ \Omega$ Remarks: Switching times may increase for V_{CE} (Clamp) $> 0.8 V_{CES}$, higher T_J or increased R_G		20	ns
t_{ri}			20	ns
E_{on}			0.15	mJ
$t_{d(off)}$			85	180 ns
t_{fi}			85	180 ns
E_{off}		0.27	0.60 mJ	
R_{thJC}			1.25	KW
R_{thCK}			0.25	KW

Min. Recommended Footprint
(Dimensions in inches and mm)

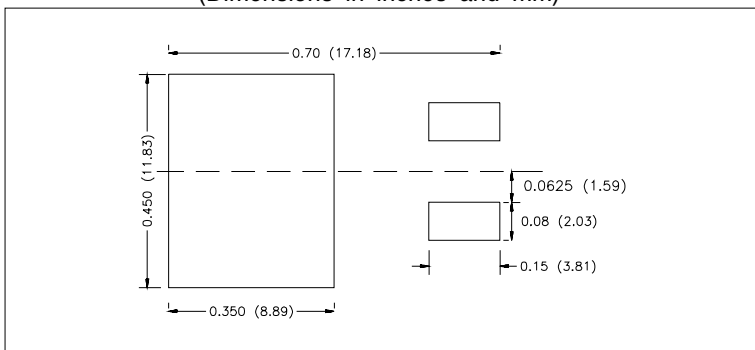

TO-220 AB Dimensions

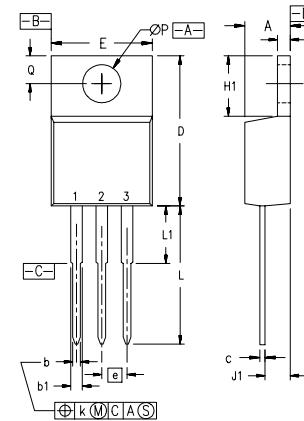

Pins: 1 - Gate
2 - Collector
3 - Emitter
4 - Collector
Bottom Side

SYM	INCHES		MILLIMETERS	
	MIN	MAX	MIN	MAX
A	.170	.190	4.32	4.83
b	.025	.040	0.64	1.02
b1	.045	.065	1.15	1.65
c	.014	.022	0.35	0.56
D	.580	.630	14.73	16.00
E	.390	.420	9.91	10.66
e	.100 BSC		2.54 BSC	
F	.045	.055	1.14	1.40
H1	.230	.270	5.85	6.85
J1	.090	.110	2.29	2.79
k	0	.015	0	0.38
L	.500	.550	12.70	13.97
L1	.110	.230	2.79	5.84
ØP	.139	.161	3.53	4.08
Q	.100	.125	2.54	3.18

NOTE: This drawing will meet all dimensions requirement of JEDEC outline TO-220 AB.

TO-263 AA Outline

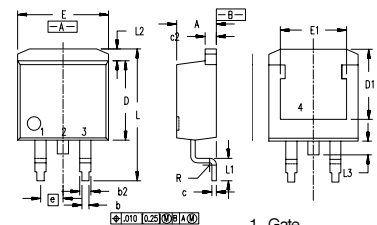

1. Gate
2. Collector
3. Emitter
4. Collector
Bottom Side

Dim.	Millimeter		Inches	
	Min.	Max.	Min.	Max.
A	4.06	4.83	.160	.190
A1	2.03	2.79	.080	.110
b	0.51	0.99	.020	.039
b2	1.14	1.40	.045	.055
c	0.46	0.74	.018	.029
c2	1.14	1.40	.045	.055
D	8.64	9.65	.340	.380
D1	7.11	8.13	.280	.320
E	9.65	10.29	.380	.405
E1	6.86	8.13	.270	.320
e	2.54	BSC	.100	BSC
L	14.61	15.88	.575	.625
L1	2.29	2.79	.090	.110
L2	1.02	1.40	.040	.055
L3	1.27	1.78	.050	.070
L4	0	0.38	0	.015
R	0.46	0.74	.018	.029

IXYS reserves the right to change limits, test conditions, and dimensions.

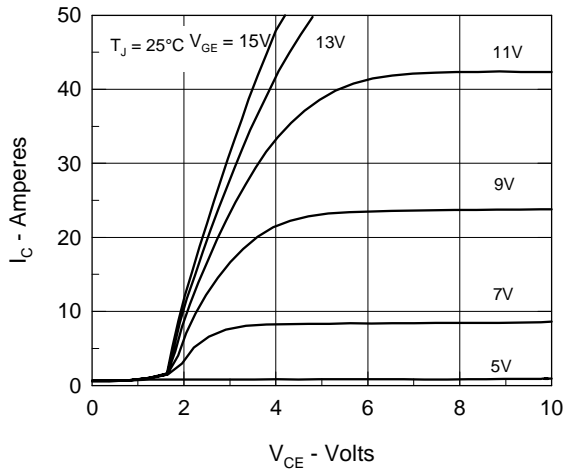

Fig. 1. Saturation Voltage Characteristics

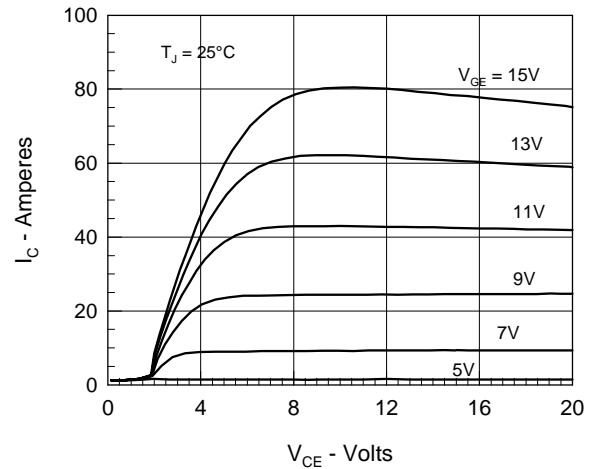

Fig. 2. Extended Output Characteristics

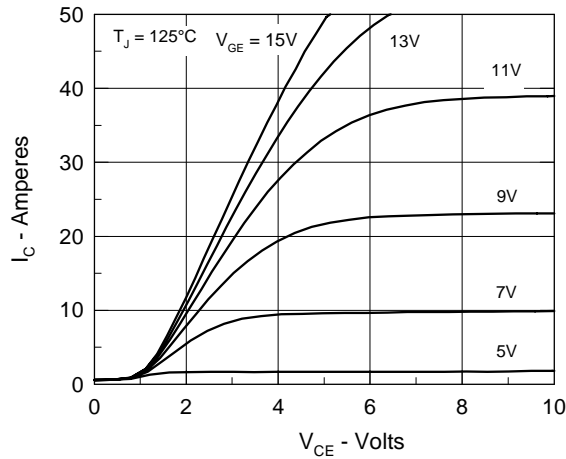

Fig. 3. Saturation Voltage Characteristics

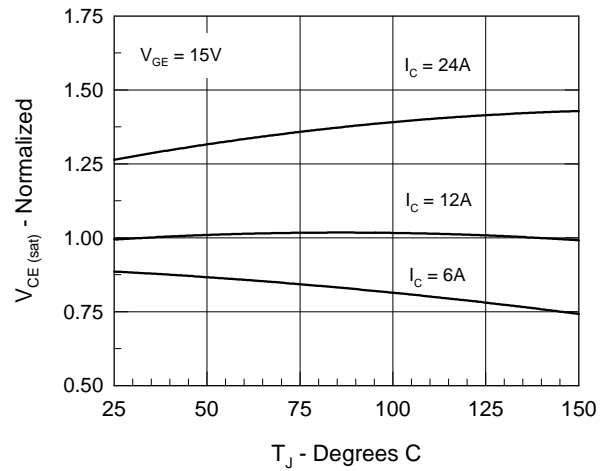
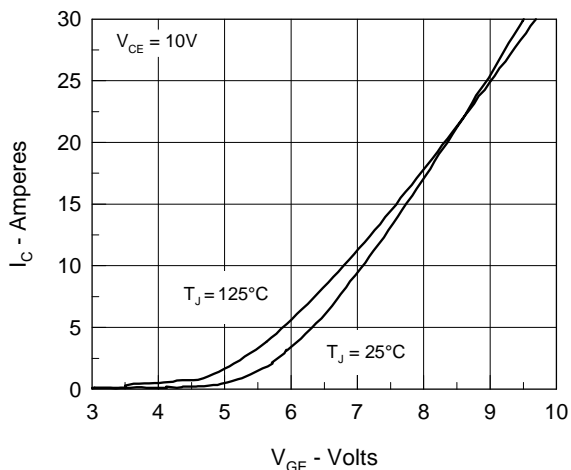

 Fig. 4. Temperature Dependence of $V_{CE(sat)}$

Fig. 5. Saturation Voltage Characteristics

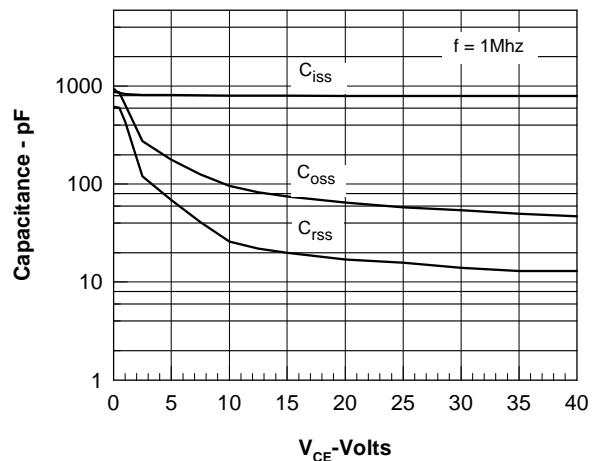

Fig. 6. Junction Capacitance Curves

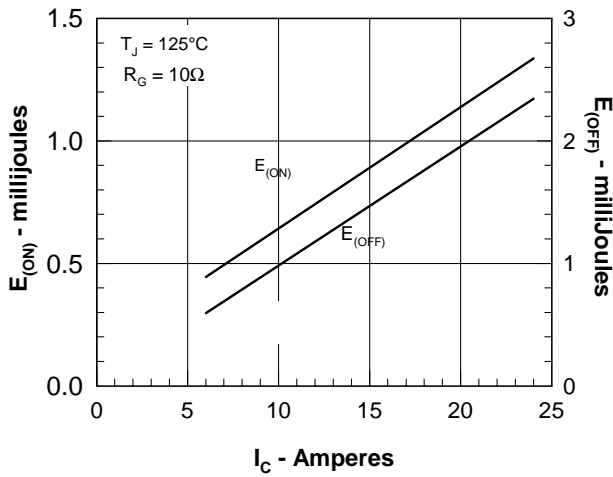

Fig. 7. Dependence of E_{ON} and E_{OFF} on I_C .

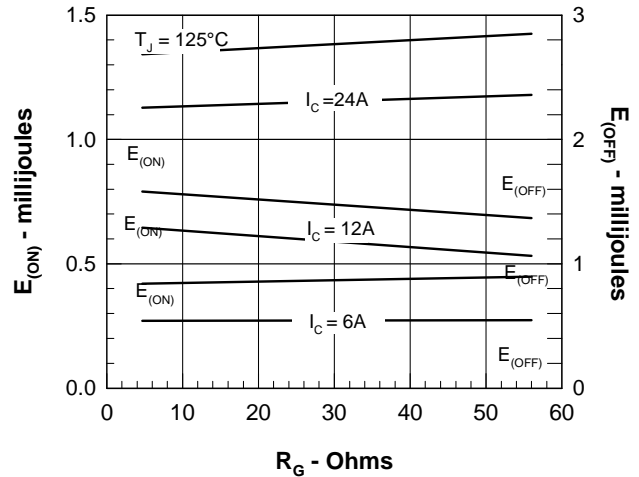

Fig. 8. Dependence of E_{ON} and E_{OFF} on R_G .

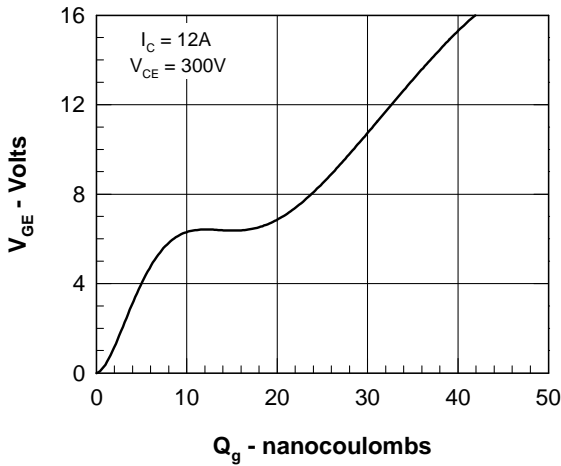

Fig. 9. Gate Charge

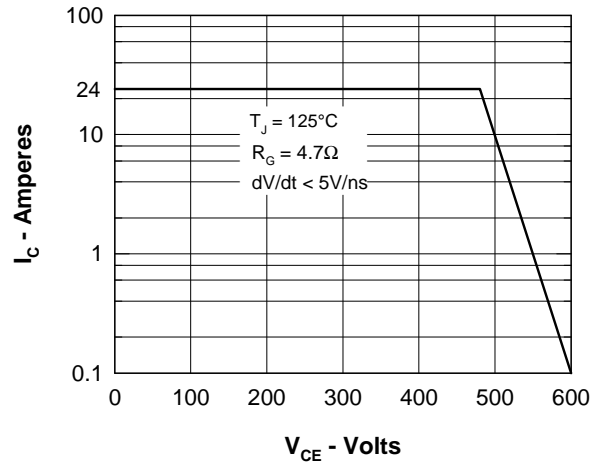

Fig. 10. Turn-off Safe Operating Area

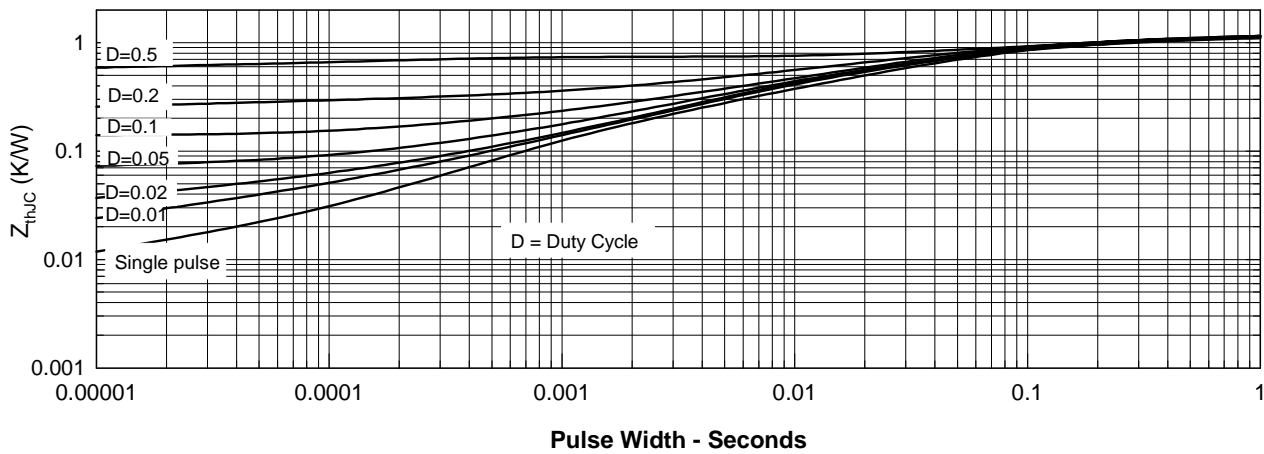

Fig. 11. Transient Thermal Resistance

IXYS reserves the right to change limits, test conditions, and dimensions.

IXYS MOSFETS and IGBTs are covered by one or more of the following U.S. patents:

4,835,592	4,881,106	5,017,508	5,049,961	5,187,117	5,486,715	6,306,728B1
4,850,072	4,931,844	5,034,796	5,063,307	5,237,481	5,381,025	