

GenX3™ 600V IGBT

IXGA48N60C3
IXGH48N60C3
IXGP48N60C3

High Speed PT IGBTs for
 40-100kHz switching

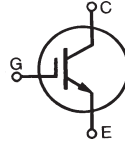

V_{CES} = 600V
I_{C110} = 48A
V_{CE(sat)} ≤ 2.5V
t_{fi(typ)} = 38ns

Symbol	Test Conditions	Maximum Ratings	
V _{CES}	T _C = 25°C to 150°C	600	V
V _{CGR}	T _J = 25°C to 150°C, R _{GE} = 1MΩ	600	V
V _{GES}	Continuous	± 20	V
V _{GEM}	Transient	± 30	V
I _{C25}	T _C = 25°C (Limited by Leads)	75	A
I _{C110}	T _C = 110°C	48	A
I _{CM}	T _C = 25°C, 1ms	250	A
I _A	T _C = 25°C	30	A
E _{AS}	T _C = 25°C	300	mJ
SSOA (RBSOA)	V _{GE} = 15V, T _{VJ} = 125°C, R _G = 3Ω Clamped Inductive Load @ ≤ 600V	I _{CM} = 100	A
P _C	T _C = 25°C	300	W
T _J		-55 ... +150	°C
T _{JM}		150	°C
T _{stg}		-55 ... +150	°C
T _L	1.6mm (0.062 in.) from Case for 10s	300	°C
T _{SOLD}	Plastic Body for 10 Seconds	260	°C
M _d	Mounting Torque (TO-247&TO-220)	1.13/10	Nm/lb.in.
Weight	TO-247	6.0	g
	TO-220	3.0	g
	TO-263	2.5	g

TO-263 (IXGA)

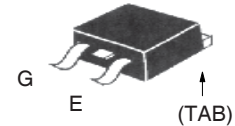

TO-247 (IXGH)

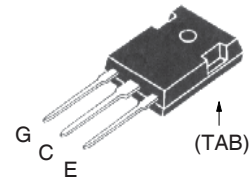

TO-220 (IXGP)

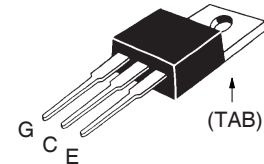

G = Gate C = Collector
 E = Emitter TAB = Collector

Features

- Optimized for Low Switching Losses
- Square RBSOA
- Avalanche Rated
- Fast Switching
- International Standard Packages

Advantages

- High Power Density
- Low Gate Drive Requirement

Applications

- High Frequency Power Inverters
- UPS
- Motor Drives
- SMPS
- PFC Circuits
- Battery Chargers
- Welding Machines
- Lamp Ballasts

Symbol	Test Conditions	Characteristic Values		
		Min.	Typ.	Max.
BV _{CES}	I _C = 250μA, V _{GE} = 0V	600		V
V _{GE(th)}	I _C = 250μA, V _{CE} = V _{GE}	3.0		5.5 V
I _{CES}	V _{CE} = V _{CES} V _{GE} = 0V T _J = 125°C			25 μA
				250 μA
I _{GES}	V _{CE} = 0V, V _{GE} = ± 20V			±100 nA
V _{CE(sat)}	I _C = 30A, V _{GE} = 15V, Note 1 T _J = 125°C		2.3	2.5 V
			1.8	V

Symbol	Test Conditions	Characteristic Values		
		Min.	Typ.	Max.
g_{fs}	$I_C = 30A, V_{CE} = 10V, \text{Note 1}$	20	30	S
C_{ies}	$V_{CE} = 25V, V_{GE} = 0V, f = 1MHz$		1960	pF
C_{oes}			207	pF
C_{res}			66	pF
Q_g	$I_C = 30A, V_{GE} = 15V, V_{CE} = 0.5 \cdot V_{CES}$		77	nC
Q_{ge}			16	nC
Q_{gc}			32	nC
$t_{d(on)}$	Inductive Load, $T_J = 25^\circ C$ $I_C = 30A, V_{GE} = 15V$ $V_{CE} = 400V, R_G = 3\Omega$		19	ns
t_{ri}			26	ns
E_{on}			0.41	mJ
$t_{d(off)}$			60	100 ns
t_{fi}			38	ns
E_{off}			0.23	0.42 mJ
$t_{d(on)}$	Inductive Load, $T_J = 125^\circ C$ $I_C = 30A, V_{GE} = 15V$ $V_{CE} = 400V, R_G = 3\Omega$		19	ns
t_{ri}			26	ns
E_{on}			0.65	mJ
$t_{d(off)}$			92	ns
t_{fi}			95	ns
E_{off}			0.57	mJ
R_{thJC}			0.42	$^\circ C/W$
R_{thCS}	(TO-247)		0.21	$^\circ C/W$
	(TO-220)		0.50	$^\circ C/W$

Note 1: Pulse Test, $t \leq 300\mu s$; Duty Cycle, $d \leq 2\%$.

TO-247 (IXGH) Outline

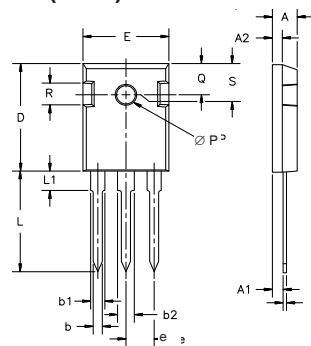

Dim.	Millimeter		Inches	
	Min.	Max.	Min.	Max.
A	4.7	5.3	.185	.209
A ₁	2.2	2.54	.087	.102
A ₂	2.2	2.6	.059	.098
b	1.0	1.4	.040	.055
b ₁	1.65	2.13	.065	.084
b ₂	2.87	3.12	.113	.123
C	.4	.8	.016	.031
D	20.80	21.46	.819	.845
E	15.75	16.26	.610	.640
e	5.20	5.72	0.205	0.225
L	19.81	20.32	.780	.800
L1		4.50		.177
ØP	3.55	3.65	.140	.144
Q	5.89	6.40	0.232	0.252
R	4.32	5.49	.170	.216
S	6.15	BSC	.242	BSC

TO-220 (IXGP) Outline

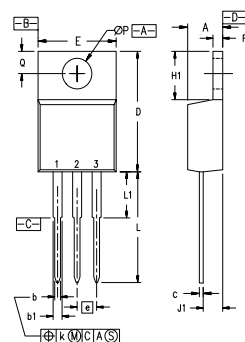

Pins: 1 - Gate 2 - Drain
3 - Source 4 - Drain

SYM	INCHES		MILLIMETERS	
	MIN	MAX	MIN	MAX
A	.170	.190	4.32	4.83
b	.025	.040	0.64	1.02
b1	.045	.065	1.15	1.65
c	.014	.022	0.35	0.56
D	.580	.630	14.73	16.00
E	.390	.420	9.91	10.66
e	.100 BSC		2.54 BSC	
F	.045	.055	1.14	1.40
H1	.230	.270	5.85	6.85
J1	.090	.110	2.29	2.79
k	0	.015	0	0.38
L	.500	.550	12.70	13.97
L1	.110	.230	2.79	5.84
ØP	.139	.161	3.53	4.08
Q	.100	.125	2.54	3.18

TO-263 (IXGA) Outline

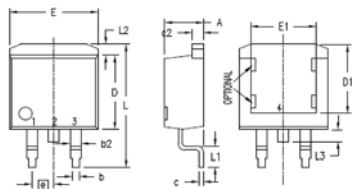

1. GATE (COLLECTOR)
2. DRAIN (COLLECTOR)
3. SOURCE (EMITTER)
4. DRAIN (COLLECTOR) BOTTOM SIDE

SYM	INCHES		MILLIMETERS	
	MIN	MAX	MIN	MAX
A	.160	.190	4.06	4.83
A1	.080	.110	2.03	2.79
b	.020	.039	0.51	0.99
b2	.045	.055	1.14	1.40
c	.016	.029	0.40	0.74
c2	.045	.055	1.14	1.40
D	.340	.380	8.64	9.65
D1	.315	.350	8.00	8.89
E	.380	.410	9.65	10.41
E1	.245	.320	6.22	8.13
e	.100 BSC		2.54 BSC	
L	.575	.625	14.61	15.88
L1	.090	.110	2.29	2.79
L2	.040	.055	1.02	1.40
L3	.050	.070	1.27	1.78
L4	0	.005	0	0.13

IXYS reserves the right to change limits, test conditions and dimensions.

IXYS MOSFETs and IGBTs are covered 4,835,592 4,931,844 5,049,961 5,237,481 6,162,665 6,404,065 B1 6,683,344 6,727,585 7,005,734 B2 7,157,338 B2
by one or more of the following U.S. patents: 4,850,072 5,017,508 5,063,307 5,381,025 6,259,123 B1 6,534,343 6,710,405 B2 6,759,692 7,063,975 B2
4,881,106 5,034,796 5,187,117 5,486,715 6,306,728 B1 6,583,505 6,710,463 6,771,478 B2 7,071,537

Fig. 1. Output Characteristics @ 25°C

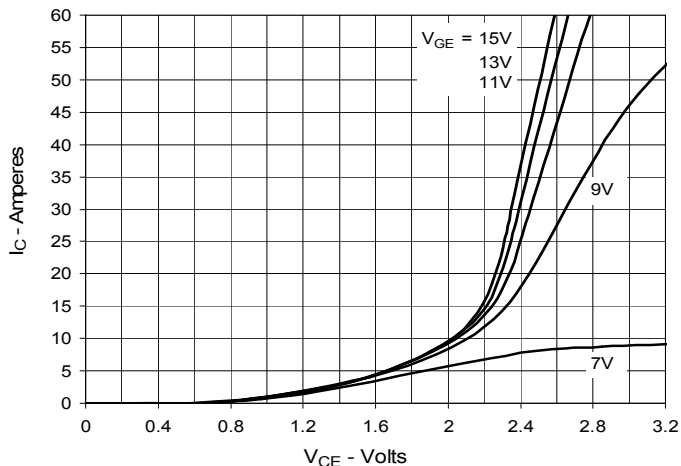

Fig. 2. Extended Output Characteristics @ 25°C

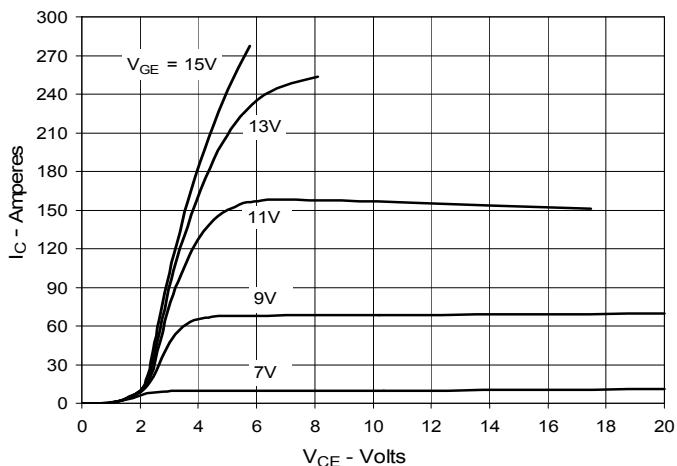

Fig. 3. Output Characteristics @ 125°C

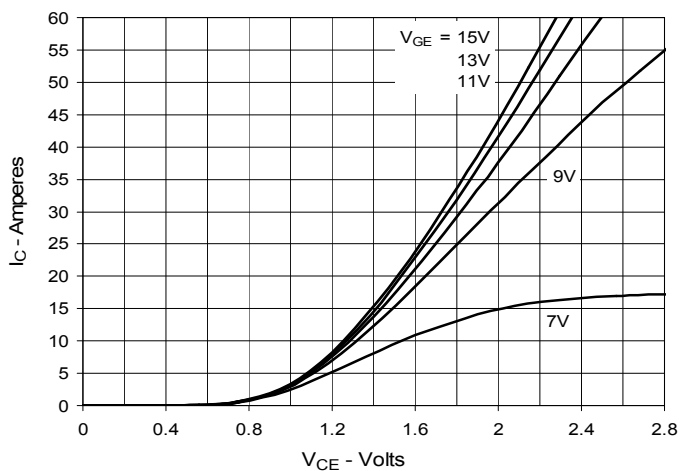

Fig. 4. Dependence of VCE(sat) on Junction Temperature

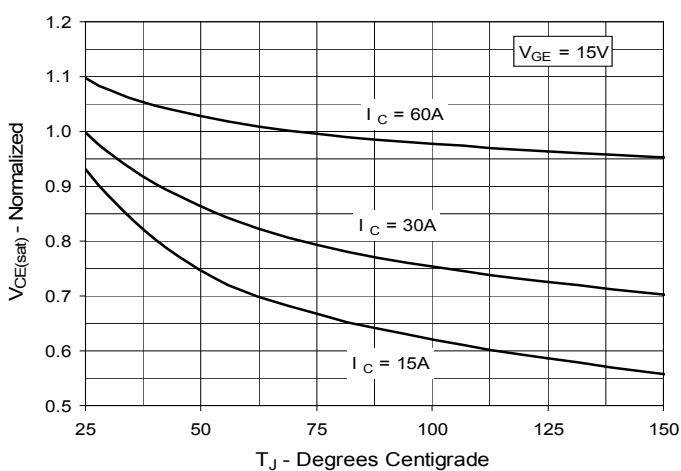

Fig. 5. Collector-to-Emitter Voltage vs. Gate-to-Emitter Voltage

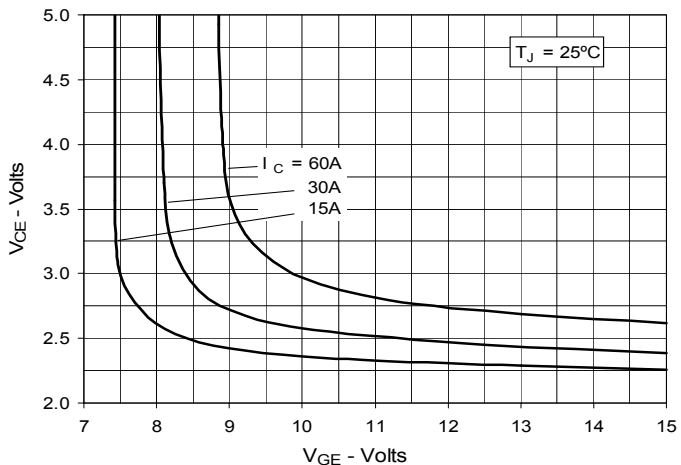

Fig. 6. Input Admittance

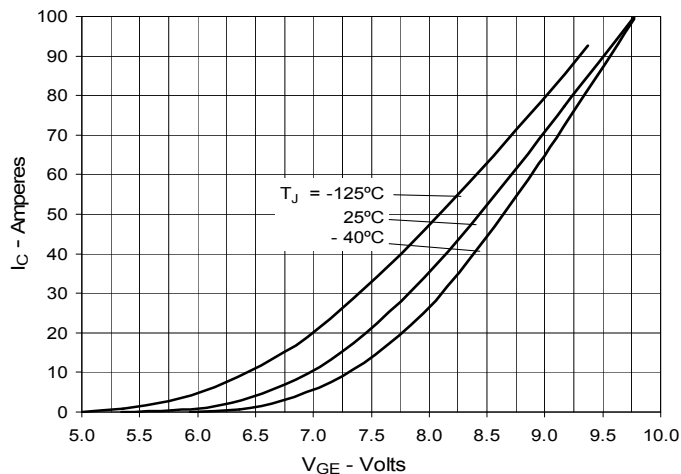

Fig. 7. Transconductance

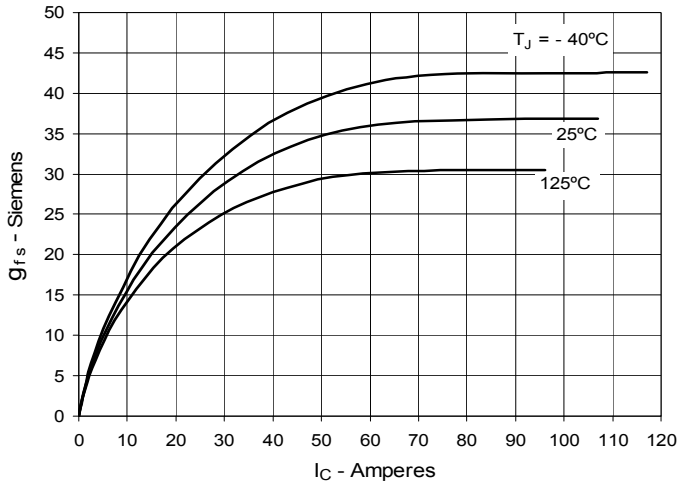

Fig. 8. Gate Charge

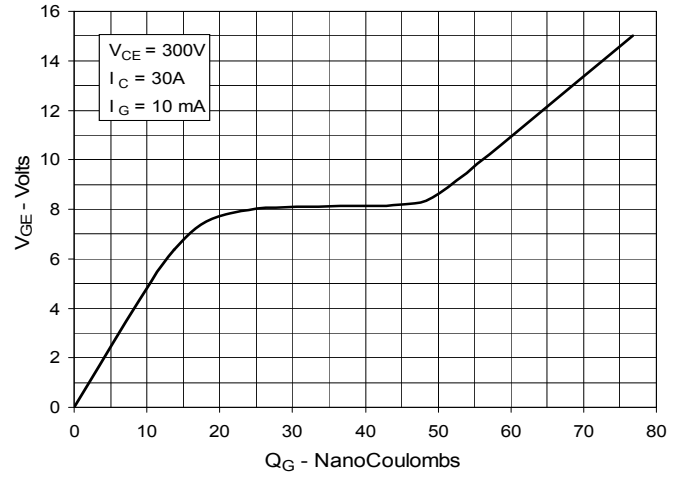

Fig. 9. Capacitance

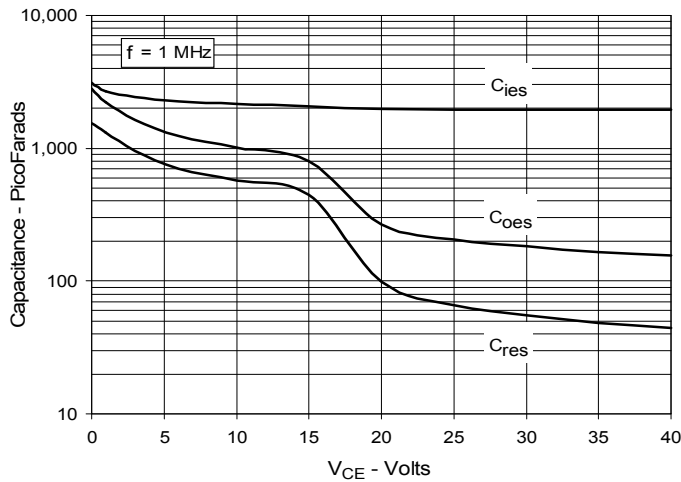

Fig. 10. Reverse-Bias Safe Operating Area

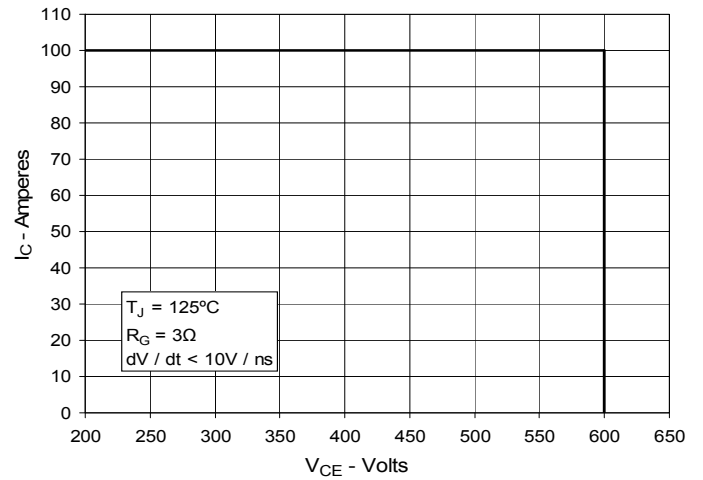
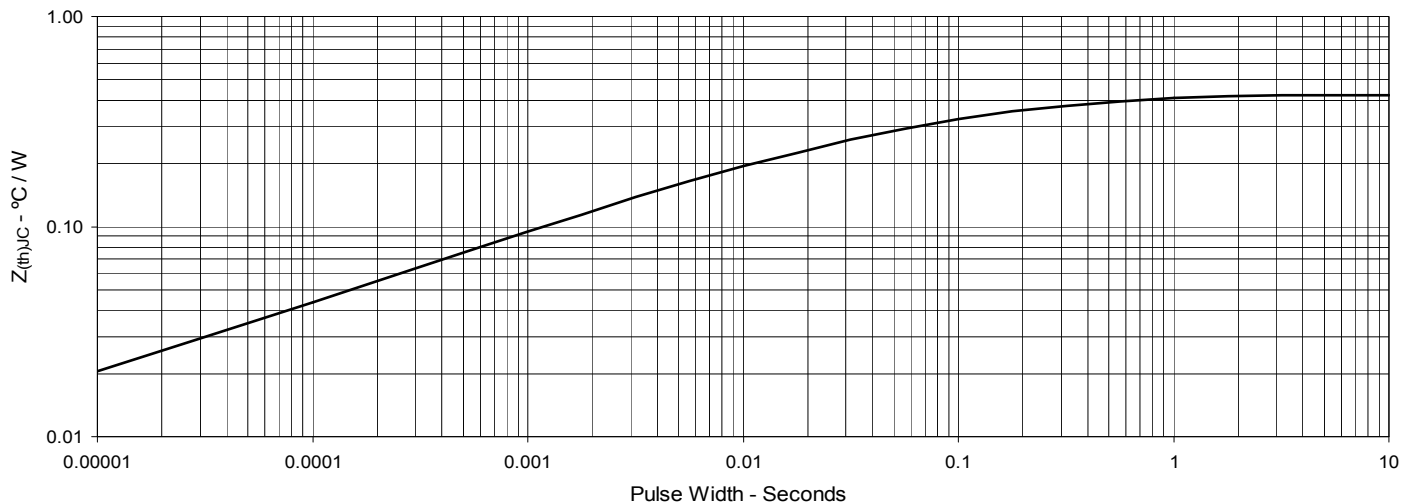

Fig. 11. Maximum Transient Thermal Impedance



IXYS reserves the right to change limits, test conditions and dimensions.

Fig. 12. Inductive Switching Energy Loss vs. Gate Resistance

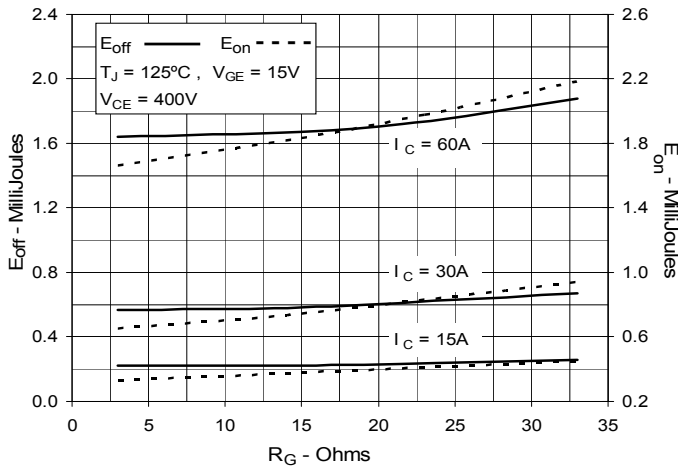

Fig. 13. Inductive Switching Energy Loss vs. Collector Current

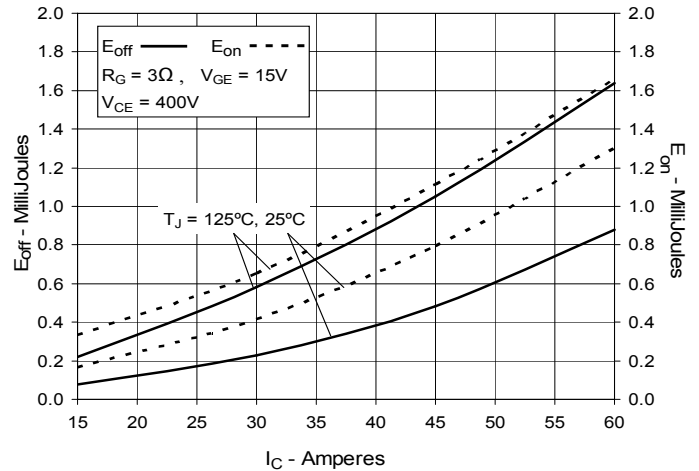

Fig. 14. Inductive Switching Energy Loss vs. Junction Temperature

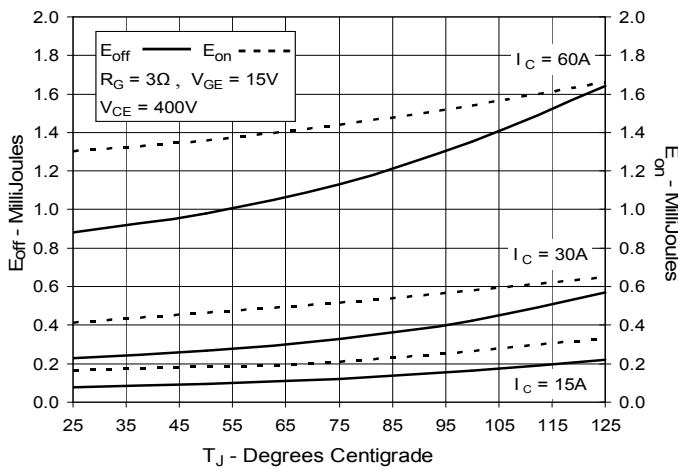

Fig. 15. Inductive Turn-off Switching Times vs. Gate Resistance

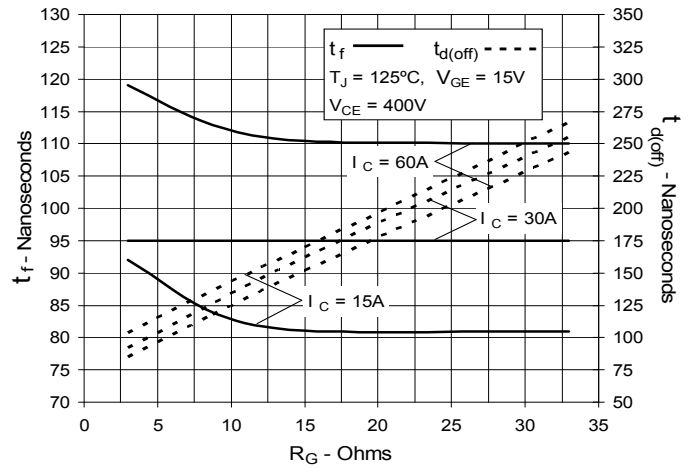

Fig. 16. Inductive Turn-off Switching Times vs. Collector Current

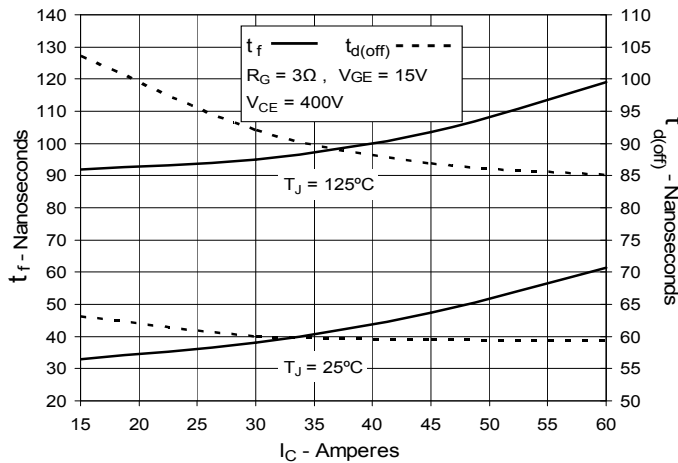
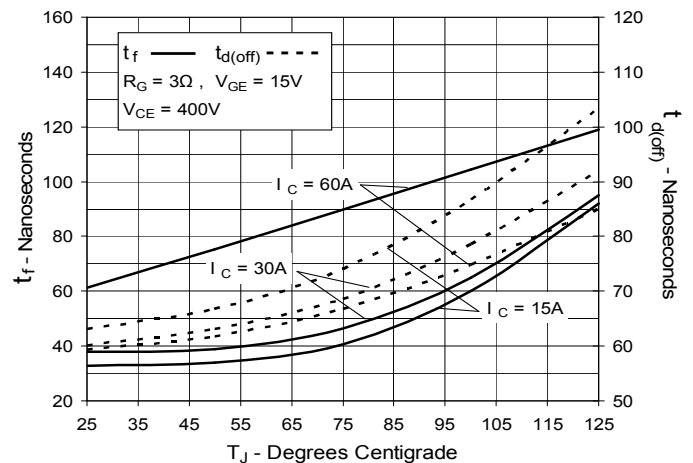
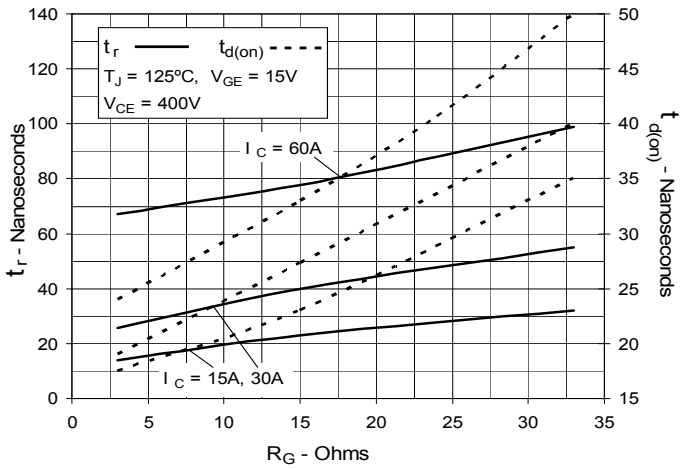

Fig. 17. Inductive Turn-off Switching Times vs. Junction Temperature



**Fig. 18. Inductive Turn-on
Switching Times vs. Gate Resistance**



**Fig. 19. Inductive Turn-on
Switching Times vs. Collector Current**

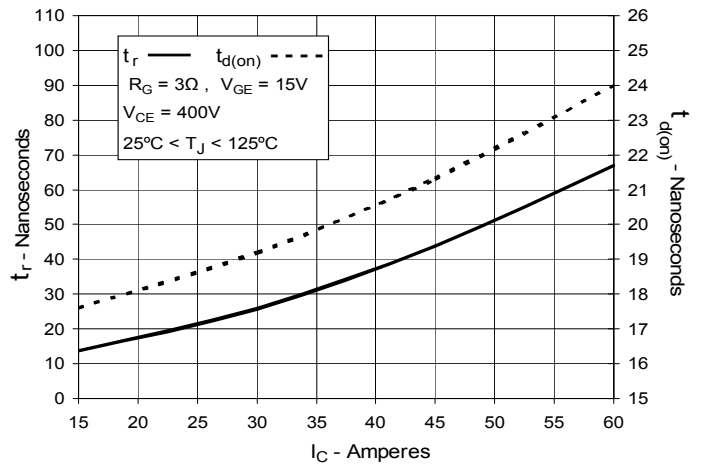

**Fig. 20. Inductive Turn-on
Switching Times vs. Junction Temperature**

