

Low $V_{CE(sat)}$ IGBT with Diode

IXGH 28N60BD1
IXGT 28N60BD1

$V_{CES} = 600\text{ V}$
 $I_{C25} = 40\text{ A}$
 $V_{CE(sat)} = 2.0\text{ V}$

Combi Pack

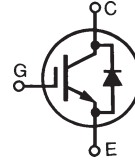

Symbol	Test Conditions	Maximum Ratings	
V_{CES}	$T_J = 25^\circ\text{C}$ to 150°C	600	V
V_{CGR}	$T_J = 25^\circ\text{C}$ to 150°C ; $R_{GE} = 1\text{ M}\Omega$	600	V
V_{GES}	Continuous	± 20	V
V_{GEM}	Transient	± 30	V
I_{C25}	$T_C = 25^\circ\text{C}$	40	A
I_{C90}	$T_C = 90^\circ\text{C}$	28	A
I_{CM}	$T_C = 25^\circ\text{C}$, 1 ms	80	A
SSOA (RBSOA)	$V_{GE} = 15\text{ V}$, $T_{VJ} = 125^\circ\text{C}$, $R_G = 10\ \Omega$ Clamped inductive load	$I_{CM} = 56$ @ $0.8 V_{CES}$	A
P_C	$T_C = 25^\circ\text{C}$	150	W
T_J		-55 ... +150	$^\circ\text{C}$
T_{JM}		150	$^\circ\text{C}$
T_{stg}		-55 ... +150	$^\circ\text{C}$
M_d	Mounting torque (M3) TO-247	1.13/10	Nm/lb.in.
Maximum lead temperature for soldering 1.6 mm (0.062 in.) from case for 10 s		300	$^\circ\text{C}$
Weight	TO-247	6	g
	TO-268	4	g

TO-268 (IXGT)

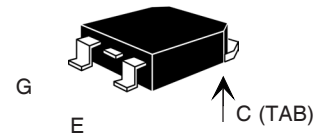

TO-247 AD (IXGH)

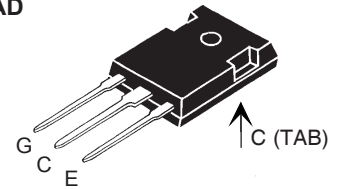

G = Gate,
E = Emitter,

C = Collector,
TAB = Collector

Features

- International standard packages
- IGBT and anti-parallel FRED in one package
- Low $V_{CE(sat)}$
 - for minimum on-state conduction losses
- MOS Gate turn-on
 - drive simplicity

Applications

- AC motor speed control
- DC servo and robot drives
- DC choppers
- Uninterruptible power supplies (UPS)
- Switch-mode and resonant-mode power supplies

Advantages

- Space savings (two devices in one package)
- Easy to mount with 1 screw (isolated mounting screw hole)
- Reduces assembly time and cost
- High power density

Symbol	Test Conditions	Characteristic Values ($T_J = 25^\circ\text{C}$, unless otherwise specified)		
		min.	typ.	max.
$V_{GE(th)}$	$I_C = 250\ \mu\text{A}$, $V_{CE} = V_{GE}$	2.5		5.5 V
I_{CES}	$V_{CE} = V_{CES}$ $V_{GE} = 0\text{ V}$	$T_J = 25^\circ\text{C}$		200 μA
		$T_J = 125^\circ\text{C}$		3 mA
I_{GES}	$V_{CE} = 0\text{ V}$, $V_{GE} = \pm 20\text{ V}$			$\pm 100\text{ nA}$
$V_{CE(sat)}$	$I_C = I_{C90}$, $V_{GE} = 15\text{ V}$			2.0 V

Symbol	Test Conditions	Characteristic Values ($T_J = 25^\circ\text{C}$, unless otherwise specified)		
		min.	typ.	max.
g_{fs}	$I_C = I_{C90}$; $V_{CE} = 10\text{ V}$, Pulse test, $t \leq 300\ \mu\text{s}$, duty cycle $\leq 2\%$	15	25	S
C_{ies} C_{oes} C_{res}	} $V_{CE} = 25\text{ V}$, $V_{GE} = 0\text{ V}$, $f = 1\text{ MHz}$		1500	pF
			170	pF
			40	pF
Q_g Q_{ge} Q_{gc}	} $I_C = I_{C90}$, $V_{GE} = 15\text{ V}$, $V_{CE} = 0.5 V_{CES}$		68	100 nC
			15	30 nC
			20	40 nC
$t_{d(on)}$ t_{ri} $t_{d(off)}$ t_{fi} E_{off}	} Inductive load, $T_J = 25^\circ\text{C}$ $I_C = I_{C90}$, $V_{GE} = 15\text{ V}$, $L = 100\ \mu\text{H}$, $V_{CE} = 0.8 V_{CES}$, $R_G = R_{off} = 10\ \Omega$ Remarks: Switching times may increase for V_{CE} (Clamp) $> 0.8 \cdot V_{CES}$, higher T_J or increased R_G		15	ns
			25	ns
			175	400 ns
			260	400 ns
			2	4 mJ
$t_{d(on)}$ t_{ri} E_{on} $t_{d(off)}$ t_{fi} E_{off}	} Inductive load, $T_J = 125^\circ\text{C}$ $I_C = I_{C90}$, $V_{GE} = 15\text{ V}$, $L = 100\ \mu\text{H}$ $V_{CE} = 0.8 V_{CES}$, $R_G = R_{off} = 10\ \Omega$ Remarks: Switching times may increase for V_{CE} (Clamp) $> 0.8 \cdot V_{CES}$, higher T_J or increased R_G		15	ns
			25	ns
			1	mJ
			400	ns
			400	ns
			3	mJ
R_{thJC} R_{thCK}	TO-247			0.83 K/W K/W

Reverse Diode (FRED)

Symbol	Test Conditions	Characteristic Values ($T_J = 25^\circ\text{C}$, unless otherwise specified)		
		min.	typ.	max.
V_F	$I_F = I_{C90}$, $V_{GE} = 0\text{ V}$, Pulse test, $t \leq 300\ \mu\text{s}$, duty cycle $d \leq 2\%$			1.6 V 2.5 V
I_{RM} t_{rr}	} $I_F = I_{C90}$, $V_{GE} = 0\text{ V}$, $-di_F/dt = 100\text{ A}/\mu\text{s}$ $V_R = 100\text{ V}$ $I_F = 1\text{ A}$; $-di/dt = 100\text{ A}/\mu\text{s}$; $V_R = 30\text{ V}$		6	A
			100	ns
			25	ns
R_{thJC}				1 K/W

TO-247 AD Outline

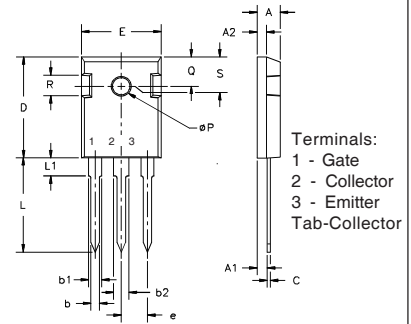

Dim.	Millimeter		Inches	
	Min.	Max.	Min.	Max.
A	4.7	5.3	.185	.209
A ₁	2.2	2.54	.087	.102
A ₂	2.2	2.6	.059	.098
b	1.0	1.4	.040	.055
b ₁	1.65	2.13	.065	.084
b ₂	2.87	3.12	.113	.123
C	.4	.8	.016	.031
D	20.80	21.46	.819	.845
E	15.75	16.26	.610	.640
e	5.20	5.72	0.205	0.225
L	19.81	20.32	.780	.800
L ₁		4.50		.177
∅P	3.55	3.65	.140	.144
Q	5.89	6.40	0.232	0.252
R	4.32	5.49	.170	.216
S	6.15	BSC	242	BSC

TO-268 Outline

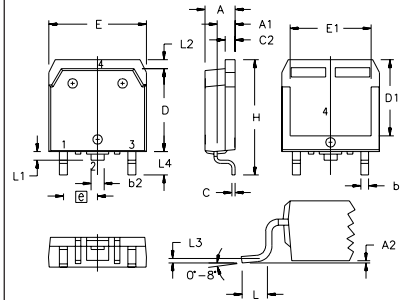

Terminals: 1 - Gate 2 - Collector
3 - Emitter Tab - Collector

SYM	INCHES		MILLIMETERS	
	MIN	MAX	MIN	MAX
A	.193	.201	4.90	5.10
A ₁	.106	.114	2.70	2.90
A ₂	.001	.010	0.02	0.25
b	.045	.057	1.15	1.45
b ₂	.075	.083	1.90	2.10
C	.016	.026	0.40	0.65
C ₂	.057	.063	1.45	1.60
D	.543	.551	13.80	14.00
D ₁	.488	.500	12.40	12.70
E	.624	.632	15.85	16.05
E ₁	.524	.535	13.30	13.60
e	.215 BSC		5.45 BSC	
H	.736	.752	18.70	19.10
L	.094	.106	2.40	2.70
L ₁	.047	.055	1.20	1.40
L ₂	.039	.045	1.00	1.15
L ₃	.010 BSC		0.25 BSC	
L ₄	.150	.161	3.80	4.10

IXYS reserves the right to change limits, test conditions, and dimensions.

**Fig. 1. Output Characteristics
@ 25 Deg. C**

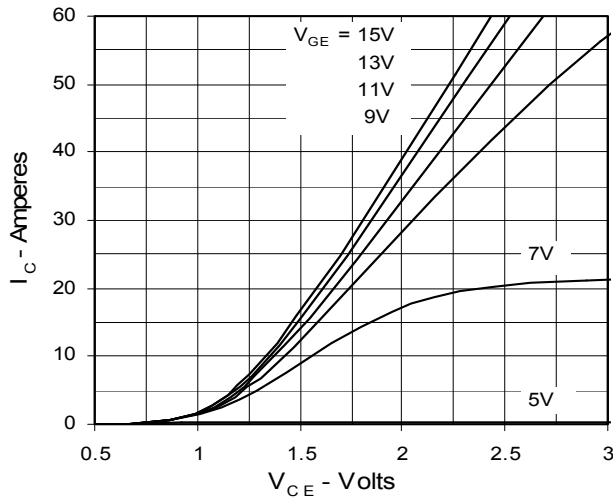

**Fig. 2. Extended Output Characteristics
@ 25 deg. C**

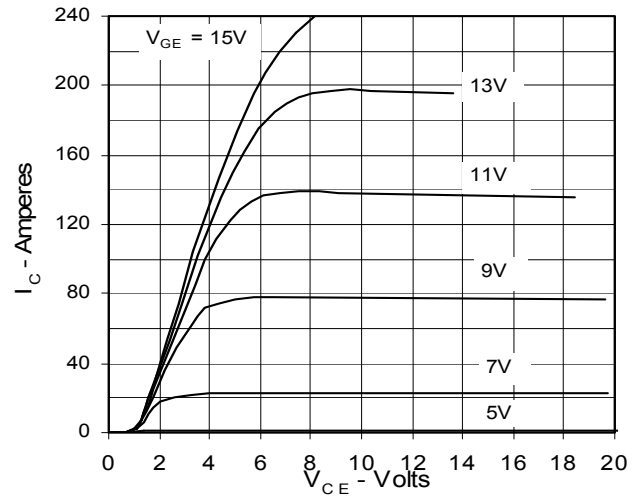

**Fig. 3. Output Characteristics
@ 125 Deg. C**

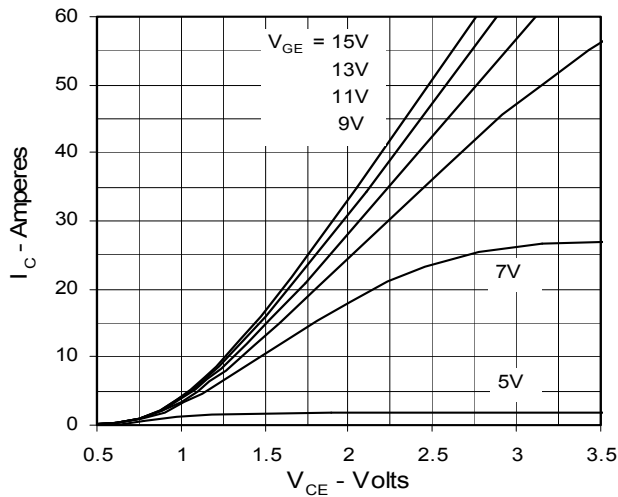
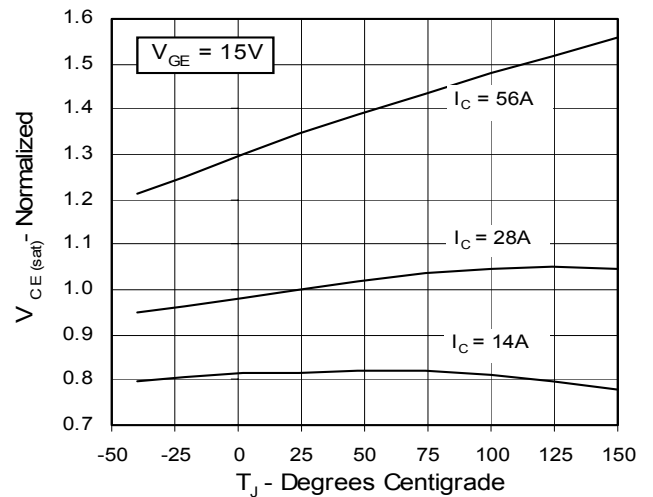

Fig. 4. Dependence of $V_{CE(sat)}$ on Temperature



**Fig. 5. Collector-to-Emitter Voltage
vs. Gate-to-Emitter voltage**

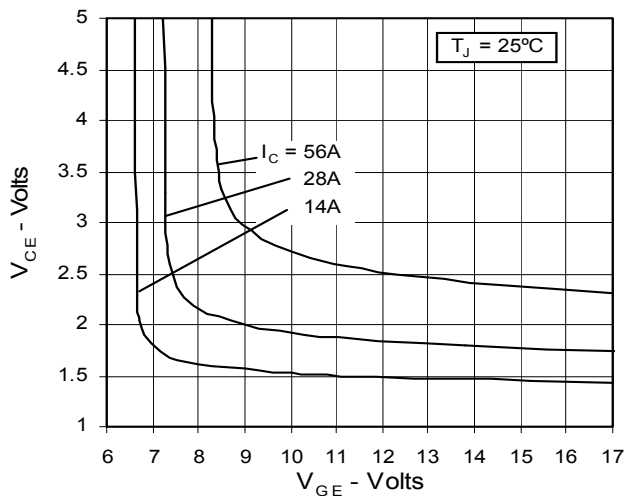

Fig. 6. Input Admittance

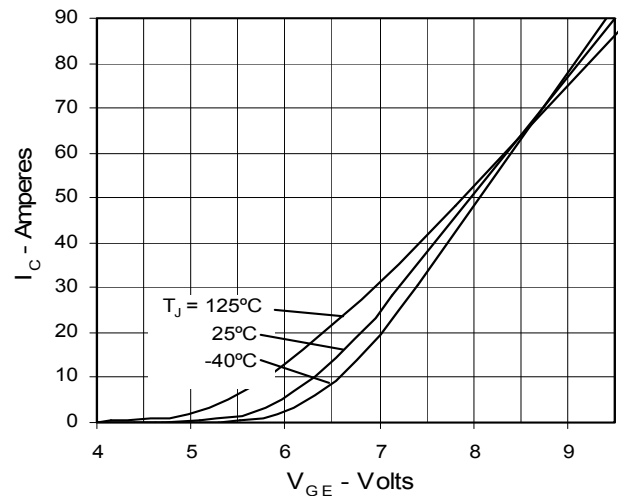

Fig. 7. Transconductance

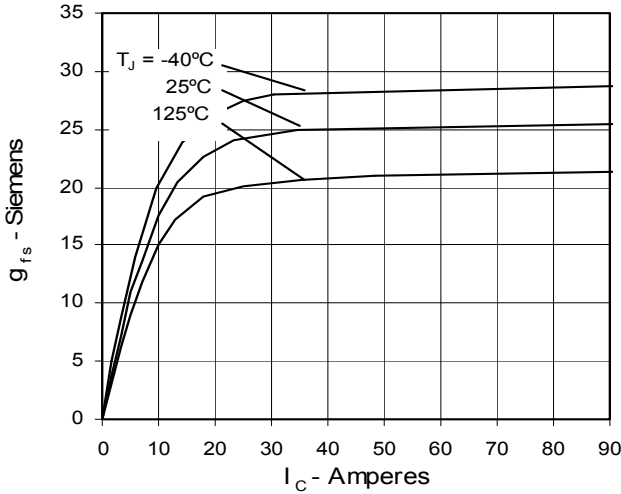

Fig. 8. Dependence of E_{off} on R_G

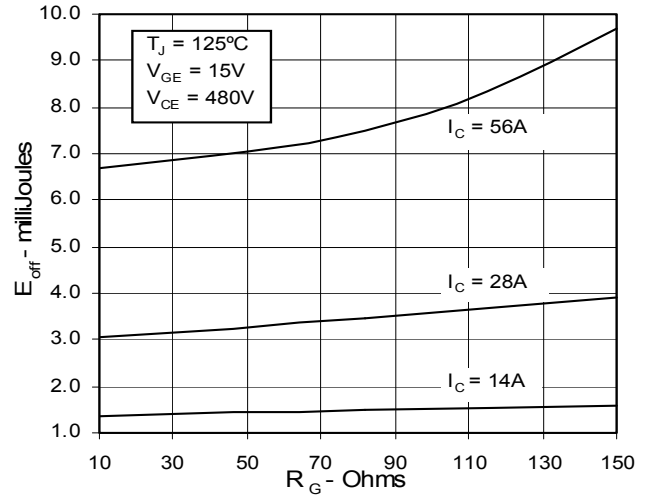

Fig. 9. Dependence of E_{off} on I_C

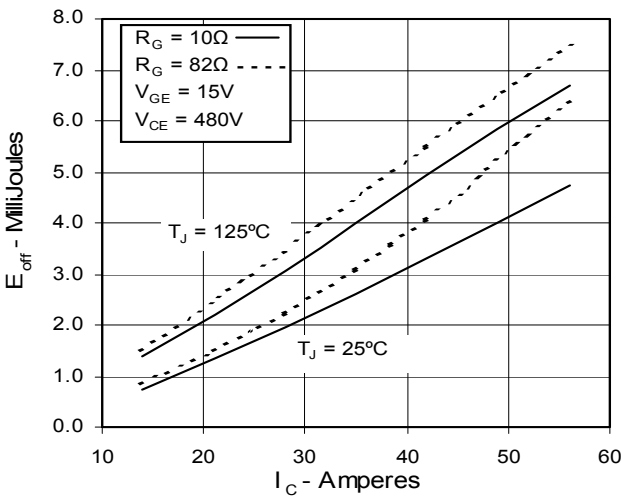

Fig. 10. Dependence of E_{off} on Temperature

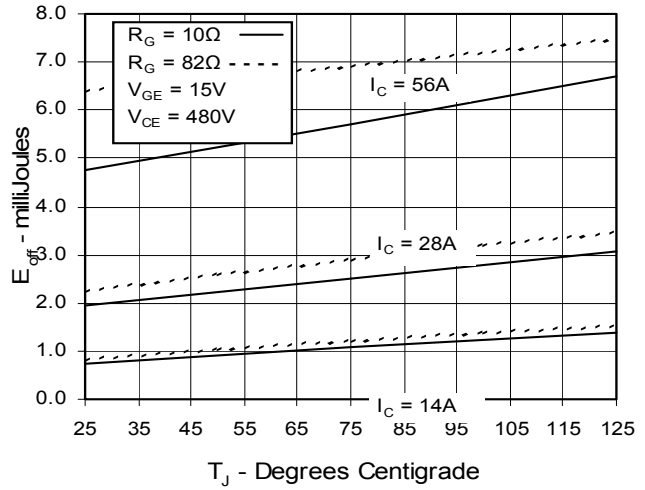

Fig. 11. Dependence of Switching Time on R_G

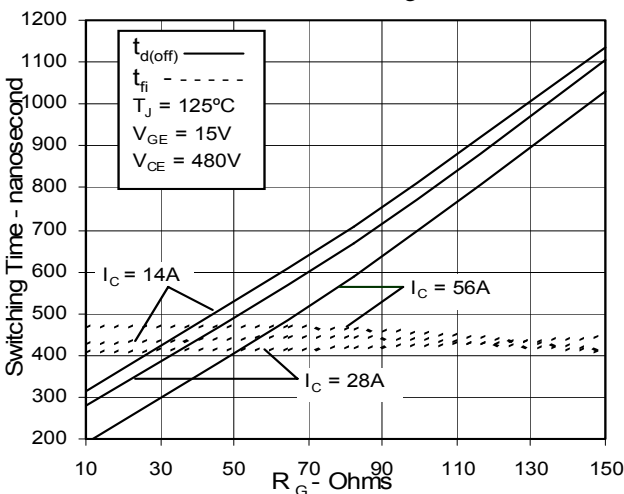
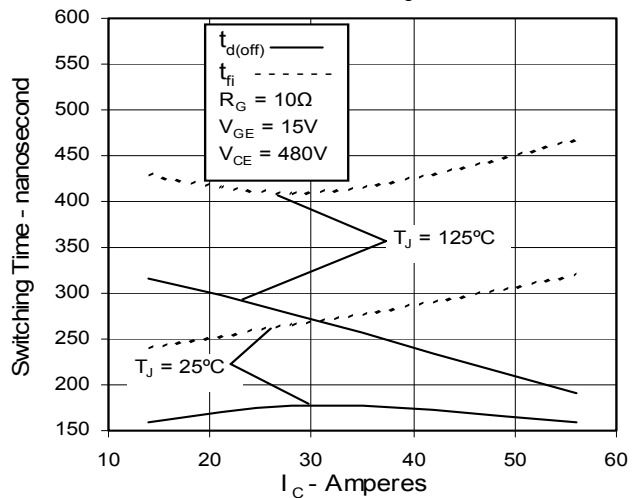

Fig. 12. Dependence of Switching Time on I_C



IXYS reserves the right to change limits, test conditions, and dimensions.

Fig. 13. Dependence of Switching Time on Temperature

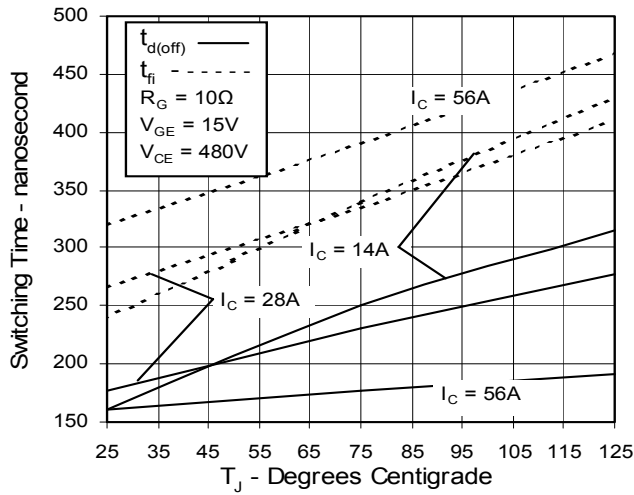

Fig. 14. Gate Charge

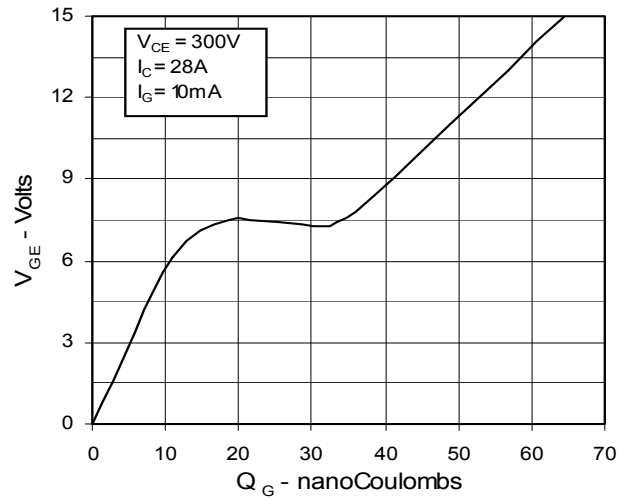

Fig. 15. Capacitance

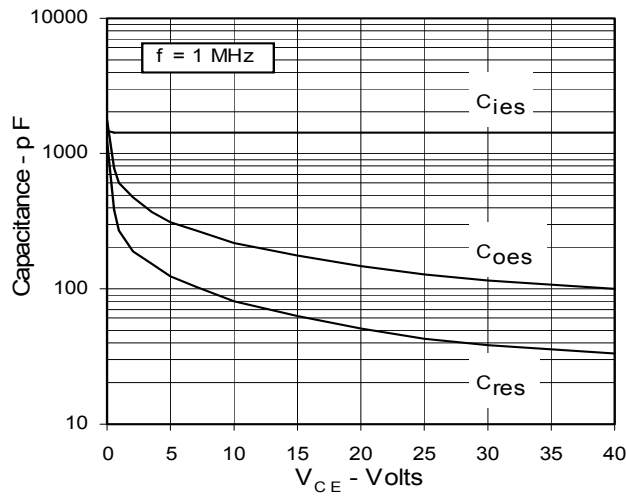
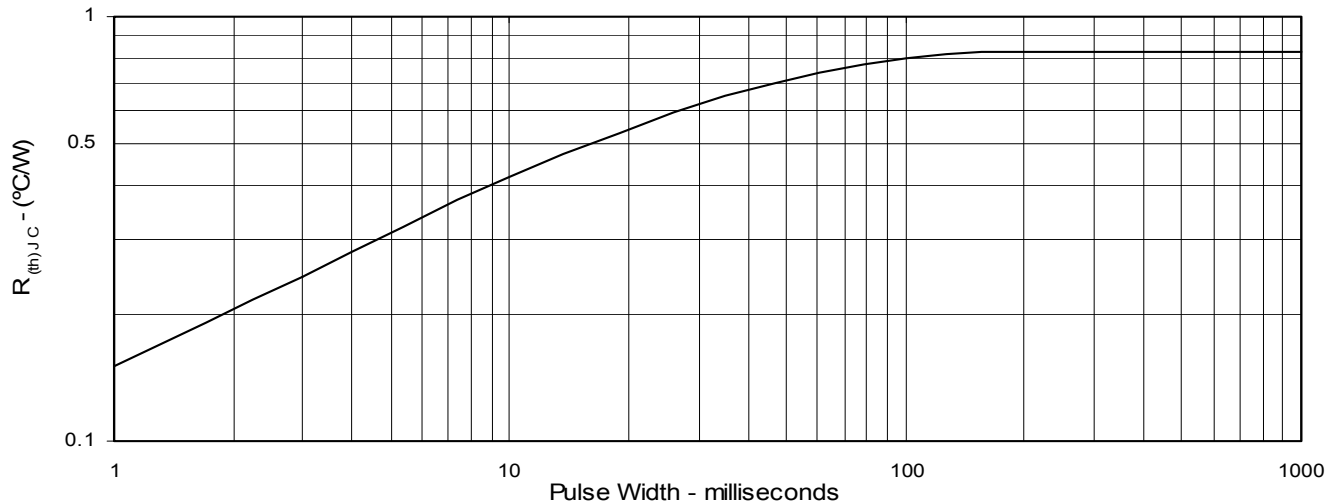

Fig. 16. Maximum Transient Thermal Resistance



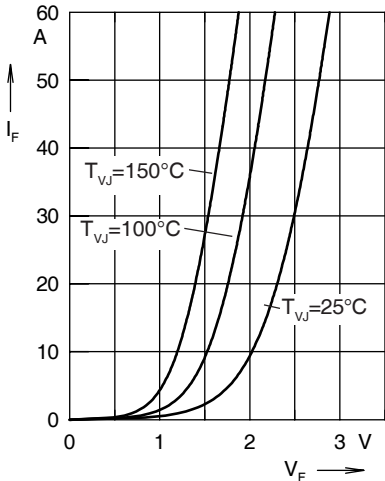

Fig. 12 Forward current I_F versus V_F

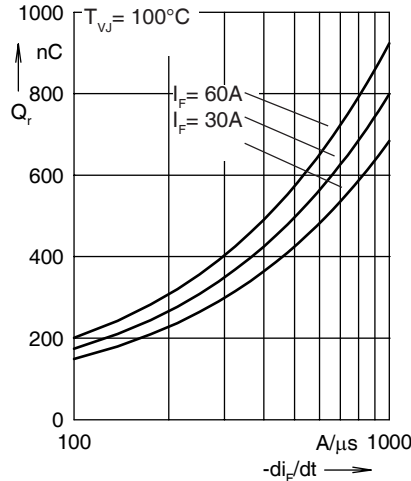

Fig. 13 Reverse recovery charge Q_r

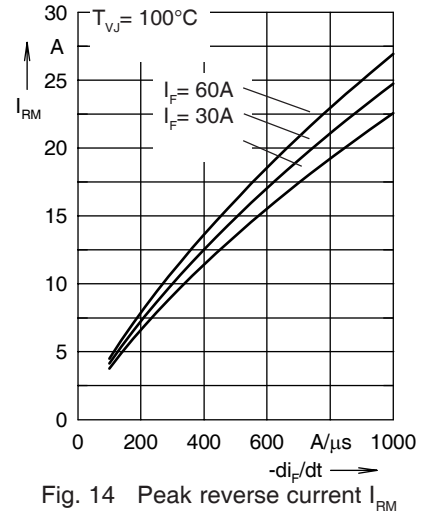

Fig. 14 Peak reverse current I_{RM}

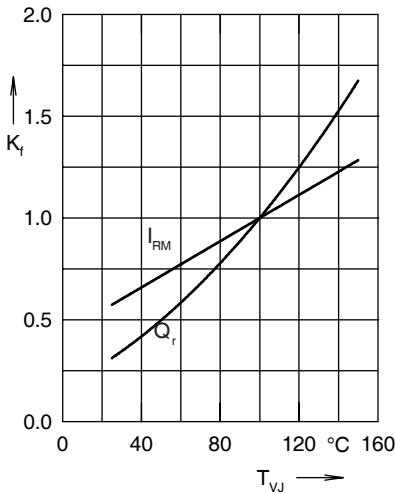

Fig. 15 Dynamic parameters Q_r , I_{RM}

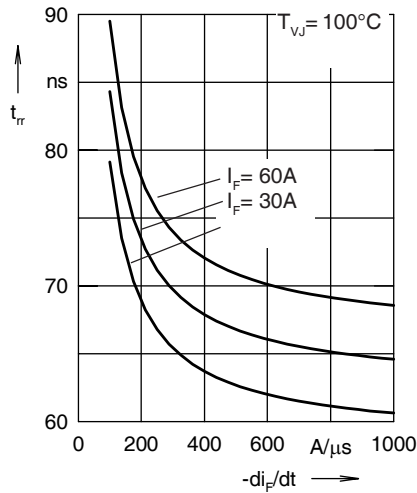

Fig. 16 Recovery time t_{rr} versus $-di_F/dt$

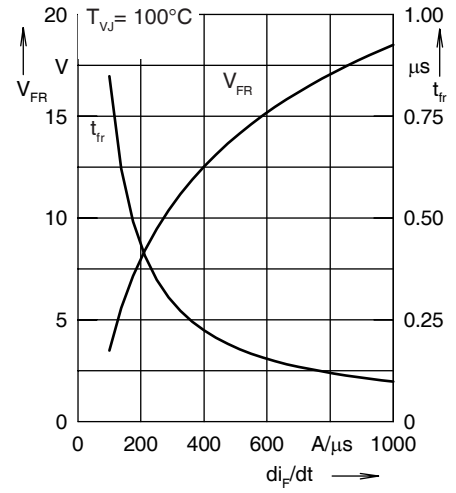

Fig. 17 Peak forward voltage V_{FR} and t_{fr}

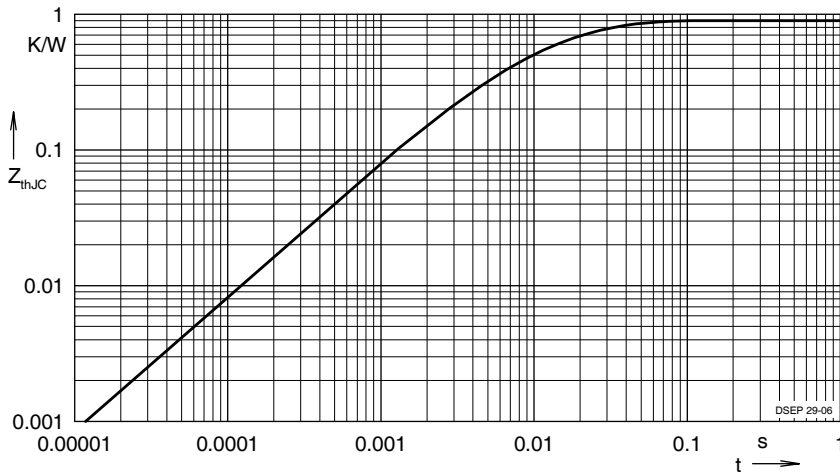

Fig. 18 Transient thermal resistance junction to case

Constants for Z_{thJC} calculation:

i	R_{thi} (K/W)	t_i (s)
1	0.502	0.0052
2	0.193	0.0003