

HiPerFAST™ IGBT

IXGH 30N60C2
IXGT 30N60C2

C2-Class High Speed IGBTs

$V_{CES} = 600 \text{ V}$
 $I_{C25} = 70 \text{ A}$
 $V_{CE(sat)} = 2.7 \text{ V}$
 $t_{fi} \text{ typ} = 32 \text{ ns}$

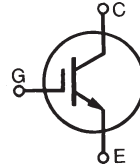

| Symbol | Test Conditions | Maximum Ratings | |
|---|---|------------------|------------------|
| V_{CES} | $T_J = 25^\circ\text{C}$ to 150°C | 600 | V |
| V_{CGR} | $T_J = 25^\circ\text{C}$ to 150°C ; $R_{GE} = 1 \text{ M}\Omega$ | 600 | V |
| V_{GES} | Continuous | ± 20 | V |
| V_{GEM} | Transient | ± 30 | V |
| I_{C25} | $T_C = 25^\circ\text{C}$ (limited by leads) | 70 | A |
| I_{C110} | $T_C = 110^\circ\text{C}$ | 30 | A |
| I_{CM} | $T_C = 25^\circ\text{C}$, 1 ms | 150 | A |
| SSOA (RBSOA) | $V_{GE} = 15 \text{ V}$, $T_{VJ} = 125^\circ\text{C}$, $R_G = 10 \Omega$ Clamped inductive load @ $\leq 600 \text{ V}$ | $I_{CM} = 60$ | A |
| P_C | $T_C = 25^\circ\text{C}$ | 190 | W |
| T_J | | -55 ... +150 | $^\circ\text{C}$ |
| T_{JM} | | 150 | $^\circ\text{C}$ |
| T_{stg} | | -55 ... +150 | $^\circ\text{C}$ |
| Maximum lead temperature for soldering 1.6 mm (0.062 in.) from case for 10 s | | 300 | $^\circ\text{C}$ |
| Plastic body for 10s | | 250 | $^\circ\text{C}$ |
| M_d | Mounting torque (M3) (TO-247) | 1.13/10Nm/lb.in. | |
| Weight | TO-247 | 6 | g |
| | TO-268 | 4 | g |

TO-268 (IXGT)

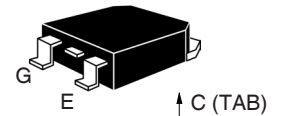

TO-247 (IXGH)

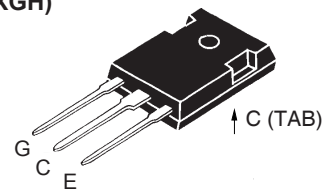

G = Gate, C = Collector,
E = Emitter, TAB = Collector

Features

- Very high frequency IGBT
- Square RBSOA
- High current handling capability
- MOS Gate turn-on
- drive simplicity

Applications

- PFC circuits
- Uninterruptible power supplies (UPS)
- Switched-mode and resonant-mode power supplies
- AC motor speed control
- DC servo and robot drives
- DC choppers

| Symbol | Test Conditions | Characteristic Values ($T_J = 25^\circ\text{C}$, unless otherwise specified) | | |
|---------------|--|---|------|--------------------------|
| | | min. | typ. | max. |
| $V_{GE(th)}$ | $I_C = 250 \mu\text{A}$, $V_{CE} = V_{GE}$ | 2.5 | | 5.0 V |
| I_{CES} | $V_{CE} = V_{CES}$ $V_{GE} = 0 \text{ V}$ | | | 50 μA 1 mA |
| I_{GES} | $V_{CE} = 0 \text{ V}$, $V_{GE} = \pm 20 \text{ V}$ | | | $\pm 100 \text{ nA}$ |
| $V_{CE(sat)}$ | $I_C = 24 \text{ A}$, $V_{GE} = 15 \text{ V}$ | | 2.0 | 2.7 V V |

| Symbol | Test Conditions | Characteristic Values ($T_J = 25^\circ\text{C}$, unless otherwise specified) | | | |
|--|--|---|------|---------------|----|
| | | min. | typ. | max. | |
| g_{fs} | $I_C = 24\text{ A}; V_{CE} = 10\text{ V}$, Pulse test, $t \leq 300\ \mu\text{s}$, duty cycle $\leq 2\%$ | 18 | 28 | S | |
| C_{ies} C_{oes} C_{res} | $V_{CE} = 25\text{ V}, V_{GE} = 0\text{ V}, f = 1\text{ MHz}$ | | 1430 | pF | |
| | | | 110 | pF | |
| | | | 40 | pF | |
| Q_g Q_{ge} Q_{gc} | $I_C = 24\text{ A}, V_{GE} = 15\text{ V}, V_{CE} = 300\text{ V}$ | | 70 | nC | |
| | | | 10 | nC | |
| | | | 23 | nC | |
| $t_{d(on)}$ t_{ri} $t_{d(off)}$ t_{fi} E_{off} | Inductive load, $T_J = 25^\circ\text{C}$ $I_C = 24\text{ A}, V_{GE} = 15\text{ V}$ $V_{CE} = 400\text{ V}, R_G = 5\ \Omega$ | | 13 | ns | |
| | | | 15 | ns | |
| | | | 70 | 140 | ns |
| | | | 60 | ns | |
| | | | 0.29 | 0.30 | mJ |
| $t_{d(on)}$ t_{ri} E_{on} $t_{d(off)}$ t_{fi} E_{off} | Inductive load, $T_J = 125^\circ\text{C}$ $I_C = 24\text{ A}, V_{GE} = 15\text{ V}$ $V_{CE} = 400\text{ V}, R_G = 5\ \Omega$ | | 13 | ns | |
| | | | 17 | ns | |
| | | | 0.22 | mJ | |
| | | | 120 | ns | |
| | | | 130 | ns | |
| | | | 0.59 | mJ | |
| R_{thJC} R_{thCK} | (TO-247) | | | 0.65 KW KW | |
| | | 0.25 | | | |

Min. Recommended Footprint (Dimensions in inches and mm)

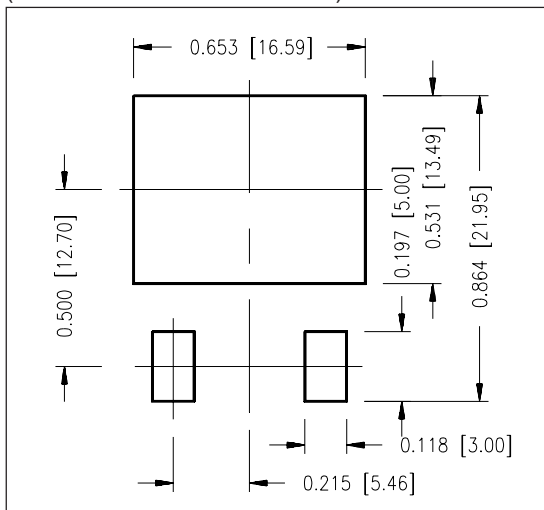

TO-247 AD Outline

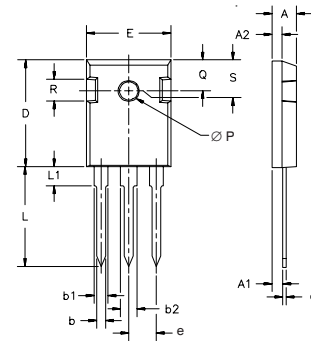

| Dim. | Millimeter | | Inches | |
|----------------|------------|-------|--------|-------|
| | Min. | Max. | Min. | Max. |
| A | 4.7 | 5.3 | .185 | .209 |
| A ₁ | 2.2 | 2.54 | .087 | .102 |
| A ₂ | 2.2 | 2.6 | .059 | .098 |
| b | 1.0 | 1.4 | .040 | .055 |
| b ₁ | 1.65 | 2.13 | .065 | .084 |
| b ₂ | 2.87 | 3.12 | .113 | .123 |
| C | .4 | .8 | .016 | .031 |
| D | 20.80 | 21.46 | .819 | .845 |
| E | 15.75 | 16.26 | .610 | .640 |
| e | 5.20 | 5.72 | 0.205 | 0.225 |
| L | 19.81 | 20.32 | .780 | .800 |
| L ₁ | | 4.50 | | .177 |
| ∅P | 3.55 | 3.65 | .140 | .144 |
| Q | 5.89 | 6.40 | 0.232 | 0.252 |
| R | 4.32 | 5.49 | .170 | .216 |
| S | 6.15 | BSC | .242 | BSC |

TO-268 Outline

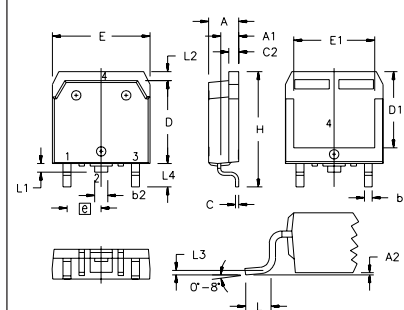

| SYM | INCHES | | MILLIMETERS | |
|----------------|----------|------|-------------|-------|
| | MIN | MAX | MIN | MAX |
| A | .193 | .201 | 4.90 | 5.10 |
| A ₁ | .106 | .114 | 2.70 | 2.90 |
| A ₂ | .001 | .010 | 0.02 | 0.25 |
| b | .045 | .057 | 1.15 | 1.45 |
| b ₂ | .075 | .083 | 1.90 | 2.10 |
| C | .016 | .026 | 0.40 | 0.65 |
| C ₂ | .057 | .063 | 1.45 | 1.60 |
| D | .543 | .551 | 13.80 | 14.00 |
| D ₁ | .488 | .500 | 12.40 | 12.70 |
| E | .624 | .632 | 15.85 | 16.05 |
| E ₁ | .524 | .535 | 13.30 | 13.60 |
| e | .215 BSC | | 5.45 BSC | |
| H | .736 | .752 | 18.70 | 19.10 |
| L | .094 | .106 | 2.40 | 2.70 |
| L ₁ | .047 | .055 | 1.20 | 1.40 |
| L ₂ | .039 | .045 | 1.00 | 1.15 |
| L ₃ | .010 BSC | | 0.25 BSC | |
| L ₄ | .150 | .161 | 3.80 | 4.10 |

IXYS reserves the right to change limits, test conditions, and dimensions.

| | | | | | | | | |
|--|-----------|-----------|-----------|-----------|--------------|--------------|--------------|--------------|
| IXYS MOSFETs and IGBTs are covered by one or more of the following U.S. patents: | 4,835,592 | 4,931,844 | 5,049,961 | 5,237,481 | 6,162,665 | 6,404,065 B1 | 6,683,344 | 6,727,585 |
| | 4,850,072 | 5,017,508 | 5,063,307 | 5,381,025 | 6,259,123 B1 | 6,534,343 | 6,710,405 B2 | 6,759,692 |
| | 4,881,106 | 5,034,796 | 5,187,117 | 5,486,715 | 6,306,728 B1 | 6,583,505 | 6,710,463 | 6,771,478 B2 |

Fig. 1. Output Characteristics
@ 25 Deg. C

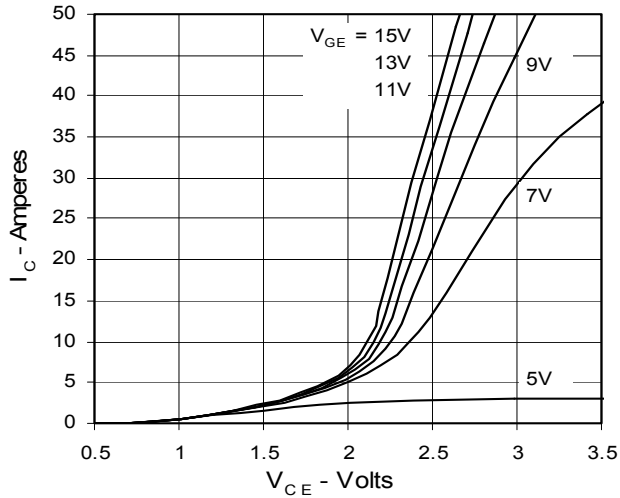

Fig. 2. Extended Output Characteristics
@ 25 deg. C

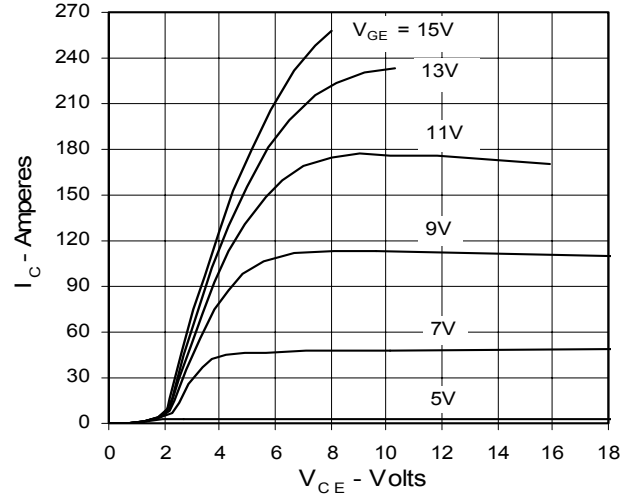

Fig. 3. Output Characteristics
@ 125 Deg. C

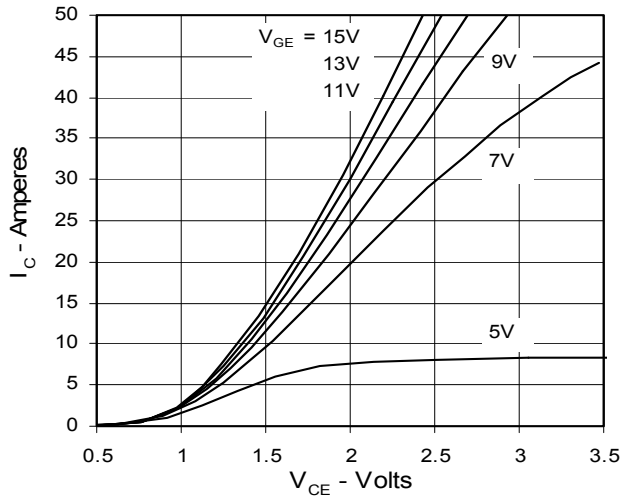

Fig. 4. Dependence of $V_{CE(sat)}$ on Temperature

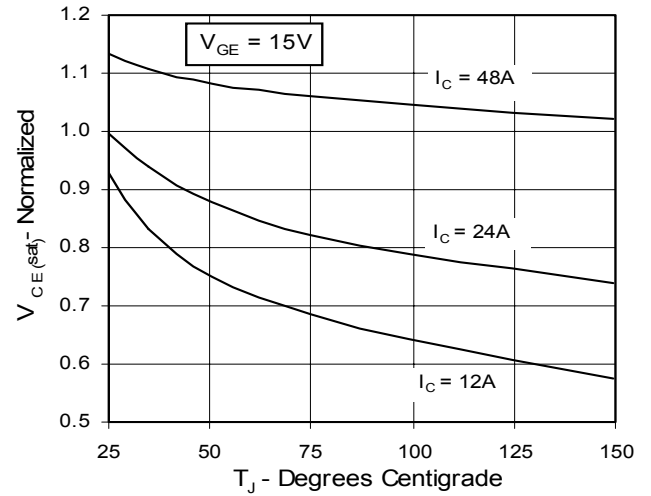

Fig. 5. Collector-to-Emitter Voltage vs. Gate-to-Emitter voltage

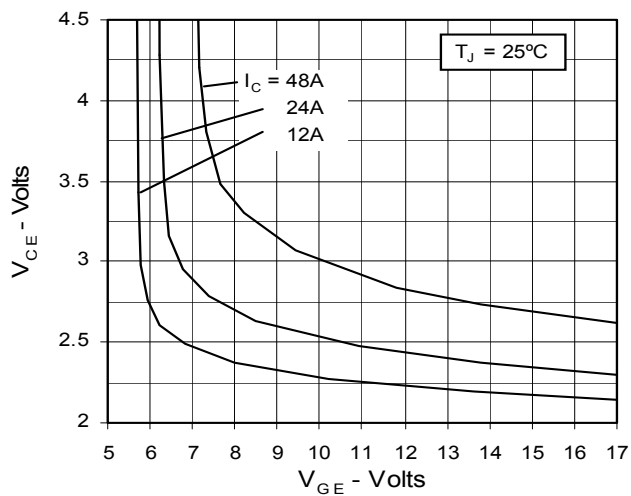

Fig. 6. Input Admittance

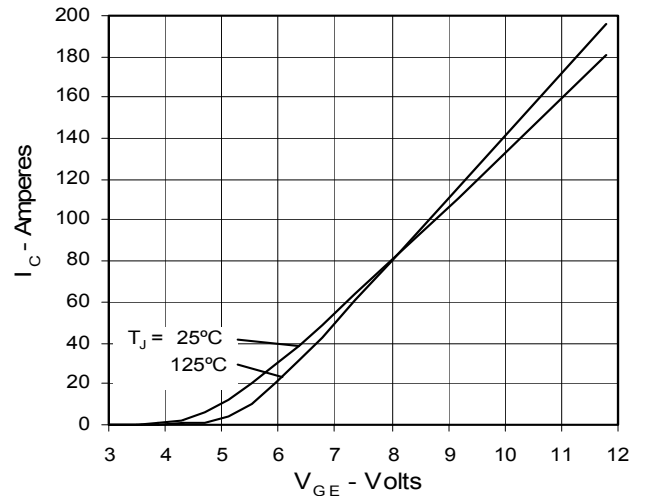

Fig. 7. Transconductance

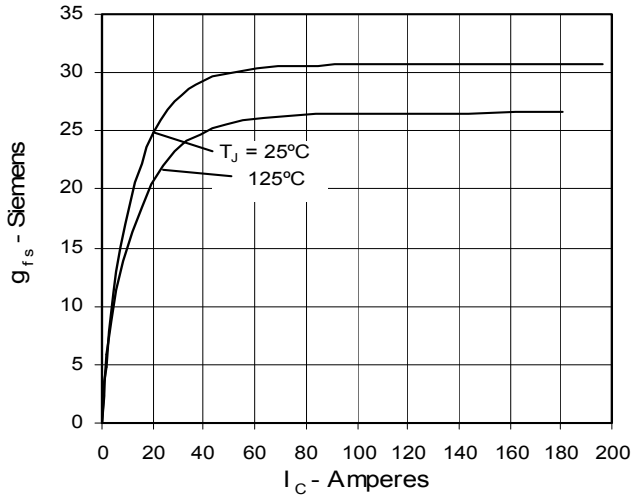

Fig. 8. Dependence of Turn-Off Energy on R_G

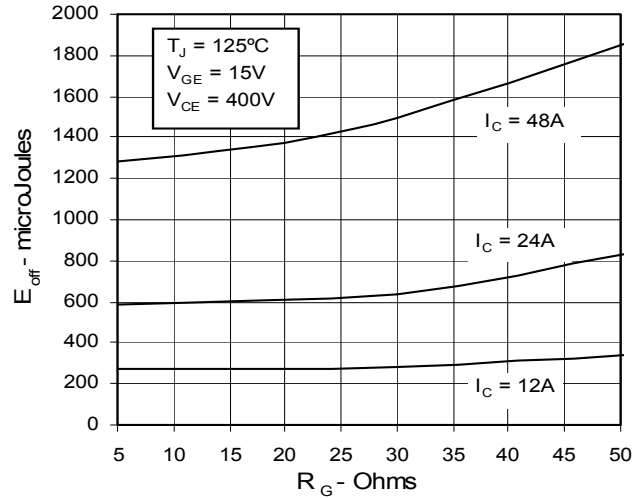

Fig. 9. Dependence of Turn-Off Energy on I_C

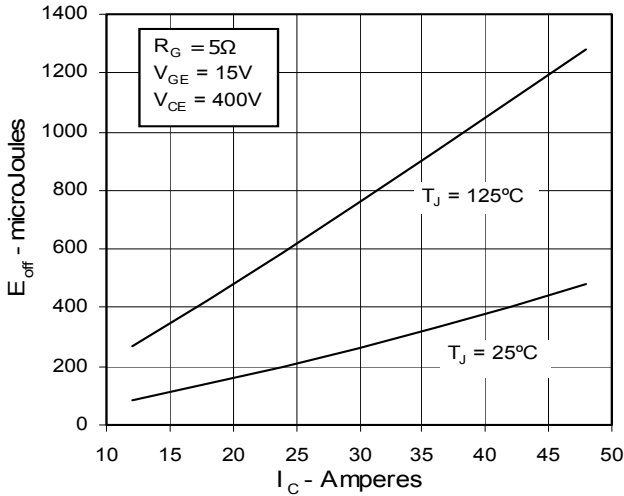

Fig. 10. Dependence of Turn-Off Energy on Temperature

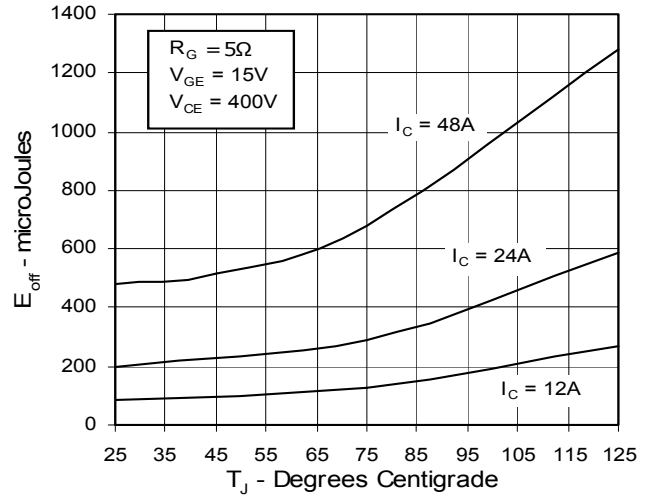

Fig. 11. Dependence of Turn-Off Switching Time on R_G

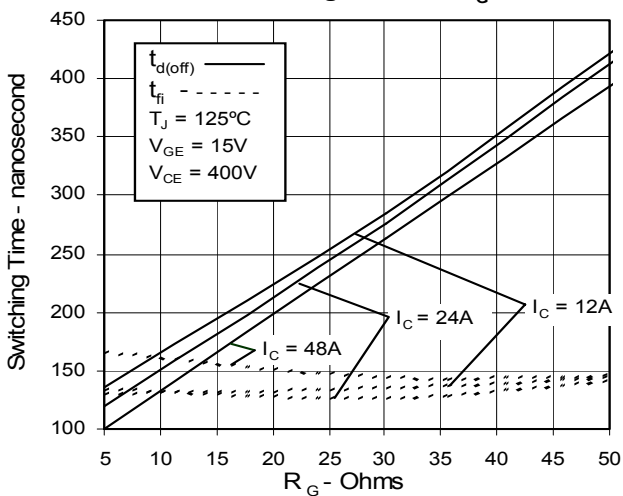

Fig. 12. Dependence of Turn-Off Switching Time on I_C

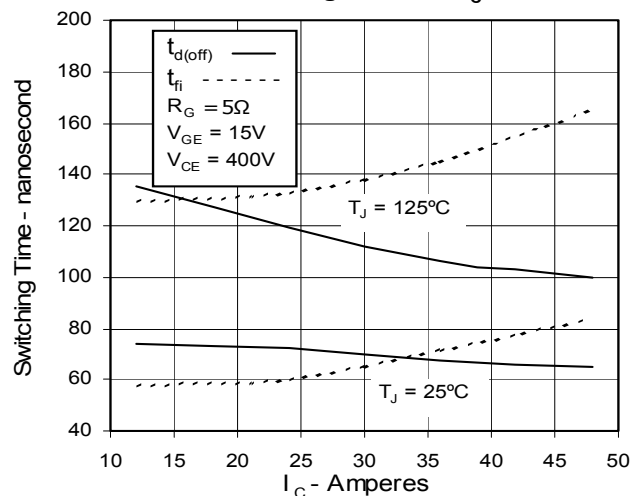

Fig. 13. Dependence of Turn-Off Switching Time on Temperature

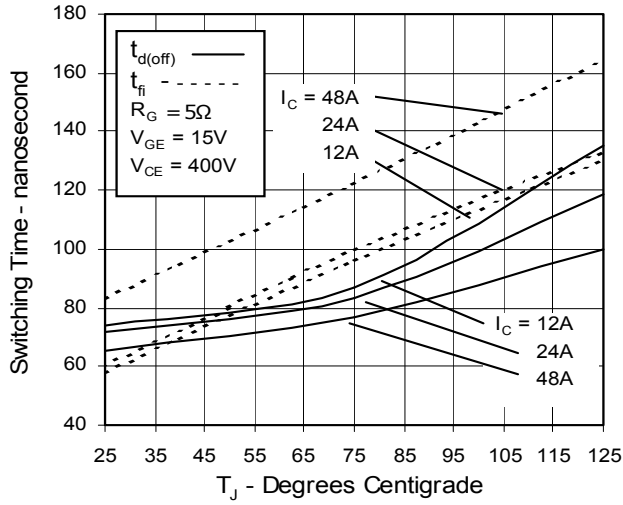

Fig. 14. Gate Charge

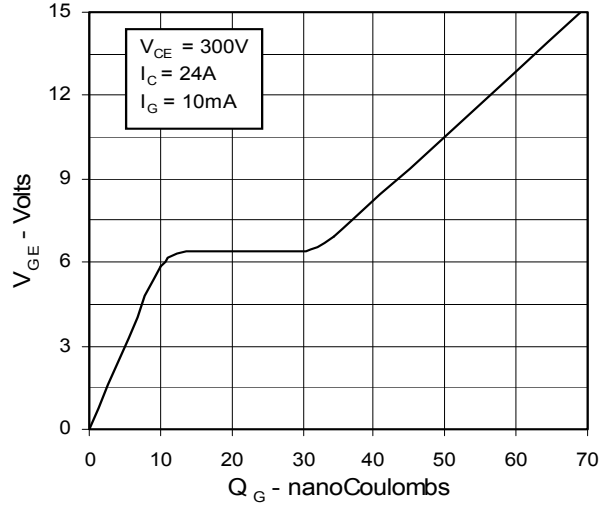

Fig. 15. Capacitance

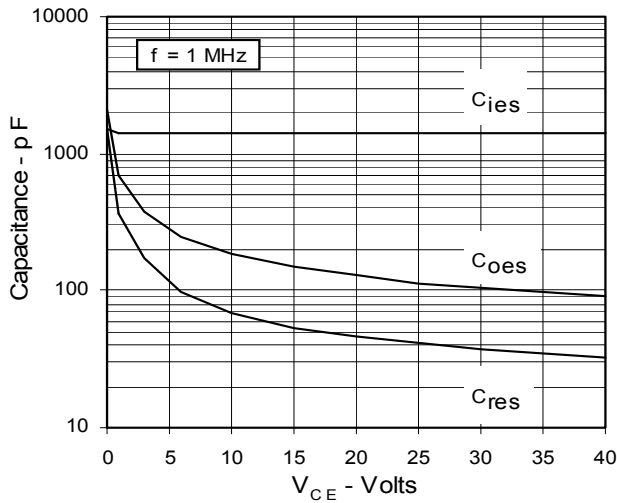

Fig. 16. Maximum Transient Thermal Resistance

