

## High Voltage IGBT

**IXGH 32N120A3**  
**IXGT 32N120A3**

$$V_{CES} = 1200 \text{ V}$$

$$I_{C25} = 75 \text{ A}$$

$$V_{CE(sat)} \leq 2.35 \text{ V}$$

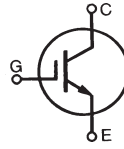

Symbol	Test Conditions	Maximum Ratings	
$V_{CES}$	$T_C = 25^\circ\text{C}$ to $150^\circ\text{C}$	1200	V
$V_{CER}$	$T_J = 25^\circ\text{C}$ to $150^\circ\text{C}$ , $R_{GE} = 1 \text{ M}\Omega$	1200	V
$V_{GES}$	Continuous	$\pm 20$	V
$V_{GEM}$	Transient	$\pm 30$	V
$I_{C25}$	$T_C = 25^\circ\text{C}$ , IGBT chip capability	75	A
$I_{C110}$	$T_C = 90^\circ\text{C}$	32	A
$I_{CM}$	$T_J \leq 150^\circ\text{C}$ , $tp < 300 \mu\text{s}$	230	A
$I_{AS}$	$T_C = 25^\circ\text{C}$	20	A
$E_{AS}$	$T_C = 25^\circ\text{C}$	120	mJ
<b>SSOA</b> <b>(RBSOA)</b>	$V_{GE} = 15 \text{ V}$ , $T_{VJ} = 150^\circ\text{C}$ , $R_G = 20 \Omega$ Clamped inductive load, $V_{CE} < 0.8 V_{CES}$	$I_{CM} = 150$	A
$P_C$	$T_C = 25^\circ\text{C}$	300	W
$T_J$		-55 ... +150	$^\circ\text{C}$
$T_{JM}$		150	$^\circ\text{C}$
$T_{stg}$		-40 ... +125	$^\circ\text{C}$
Maximum lead temperature for soldering 1.6 mm (0.062 in.) from case for 10 s Plastic body		300 260	$^\circ\text{C}$ $^\circ\text{C}$
$M_d$	Mounting torque (TO-247)	1.3/10	Nm/lb.in.
<b>Weight</b>	TO-257	6	g
	TO-268	4	g

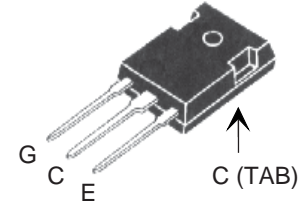
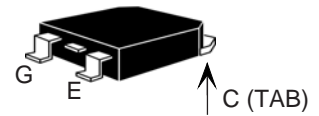
**TO-247 (IXGH)**

**TO-268 (IXGT)**

G = Gate      C = Collector  
E = Emitter    TAb = Collector

**Features**

- International standard packages
- Low saturation voltage
- Avalanche rated
- MOS Gate turn-on  
- drive simplicity
- Epoxy molding meets UL 94V-0

**Applications**

- Pulser circuits
- Capacitor discharge

Symbol	Test Conditions ( $T_J = 25^\circ\text{C}$ unless otherwise specified)	Characteristic Values		
		Min.	Typ.	Max.
$BV_{CES}$	$I_C = 250 \mu\text{A}$ , $V_{GE} = 0 \text{ V}$	1200		V
$V_{GE(th)}$	$I_C = 250 \mu\text{A}$ , $V_{CE} = V_{GE}$	3.0		5.0 V
$I_{CES}$	$V_{CE} = V_{CES}$			50 $\mu\text{A}$
	$V_{GE} = 0 \text{ V}$		$T_J = 125^\circ\text{C}$	1 mA
$I_{GES}$	$V_{CE} = 0 \text{ V}$ , $V_{GE} = \pm 20 \text{ V}$			$\pm 100 \text{ nA}$
$V_{CE(sat)}$	$I_C = I_{C110}$ , $V_{GE} = 15 \text{ V}$ , Note 1			2.35 V
	$I_C = 400 \text{ A}$ , $V_{GE} = 30 \text{ V}$		11	V

Symbol	Test Conditions ( $T_J = 25^\circ\text{C}$ unless otherwise specified)	Characteristic Values		
		Min.	Typ.	Max.
$g_{fs}$	$I_C = 50\text{ A}$ , $V_{CE} = 10\text{ V}$ , Note 1	14	20	S
$I_{C(ON)}$	$V_{CE} = 10\text{ V}$ , $V_{GE} = 15\text{ V}$ , Note 1		15	A
$C_{ies}$			2150	pF
$C_{oes}$	$V_{CE} = 25\text{ V}$ , $V_{GE} = 0\text{ V}$ , $f = 1\text{ MHz}$		130	pF
$C_{res}$			48	pF
$Q_g$			89	nC
$Q_{ge}$	$I_C = 50\text{ A}$ , $V_{GE} = 15\text{ V}$ , $V_{CE} = 0.5 V_{CES}$		15	nC
$Q_{gc}$			34	nC
$t_{d(on)}$	Resistive load		39	ns
$t_{ri}$	$I_C = 100\text{ A}$ , $V_{GE} = 20\text{ V}$ , Note 1		200	ns
$t_{d(off)}$	$V_{CE} = 960\text{ V}$ , $R_G = 10\ \Omega$		140	ns
$t_{fi}$			1240	ns
$R_{thJC}$			0.42	K/W
$R_{thCH}$	(TO-247)		0.21	K/W

Note 1: Pulse test,  $t \leq 300\text{ ms}$ , duty cycle  $\leq 2\%$

### TO-247 AD Outline

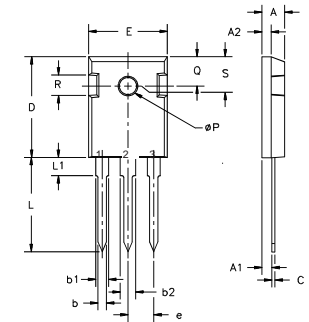

Terminals: 1 - Gate 2 - Drain  
3 - Source Tab - Drain

Dim.	Millimeter		Inches	
	Min.	Max.	Min.	Max.
A	4.7	5.3	.185	.209
A <sub>1</sub>	2.2	2.54	.087	.102
A <sub>2</sub>	2.2	2.6	.059	.098
b	1.0	1.4	.040	.055
b <sub>1</sub>	1.65	2.13	.065	.084
b <sub>2</sub>	2.87	3.12	.113	.123
C	.4	.8	.016	.031
D	20.80	21.46	.819	.845
E	15.75	16.26	.610	.640
e	5.20	5.72	0.205	0.225
L	19.81	20.32	.780	.800
L <sub>1</sub>		4.50		.177
ØP	3.55	3.65	.140	.144
Q	5.89	6.40	0.232	0.252
R	4.32	5.49	.170	.216
S	6.15	BSC	.242	BSC

### TO-268 Outline

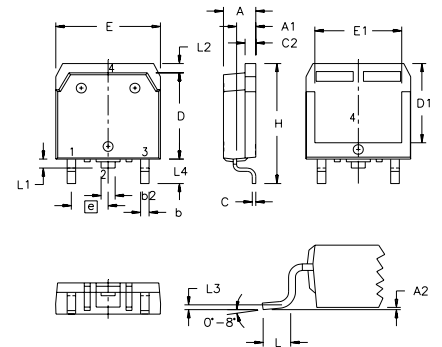

Terminals: 1 - Gate 2 - Drain  
3 - Source Tab - Drain

SYM	INCHES		MILLIMETERS	
	MIN	MAX	MIN	MAX
A	.193	.201	4.90	5.10
A <sub>1</sub>	.106	.114	2.70	2.90
A <sub>2</sub>	.001	.010	0.02	0.25
b	.045	.057	1.15	1.45
b <sub>2</sub>	.075	.083	1.90	2.10
C	.016	.026	0.40	0.65
C <sub>2</sub>	.057	.063	1.45	1.60
D	.543	.551	13.80	14.00
D <sub>1</sub>	.488	.500	12.40	12.70
E	.624	.632	15.85	16.05
E <sub>1</sub>	.524	.535	13.30	13.60
e		.215 BSC		5.45 BSC
H	.736	.752	18.70	19.10
L	.094	.106	2.40	2.70
L <sub>1</sub>	.047	.055	1.20	1.40
L <sub>2</sub>	.039	.045	1.00	1.15
L <sub>3</sub>		.010 BSC		0.25 BSC
L <sub>4</sub>	.150	.161	3.80	4.10

### PRELIMINARY TECHNICAL INFORMATION

The product presented herein is under development. The Technical Specifications offered are derived from data gathered during objective characterizations of preliminary engineering lots; but also may yet contain some information supplied during a pre-production design evaluation. IXYS reserves the right to change limits, test conditions, and dimensions without notice.

IXYS reserves the right to change limits, test conditions and dimensions.

**Fig. 1. Output Characteristics  
@ 25°C**

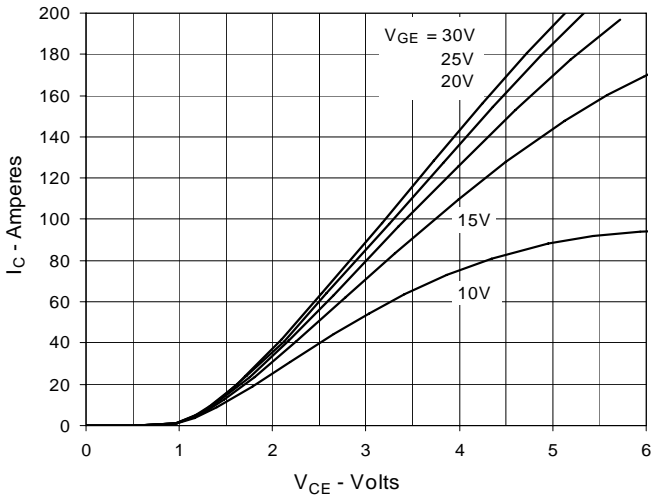

**Fig. 2. Extended Output Characteristics  
@ 25°C**

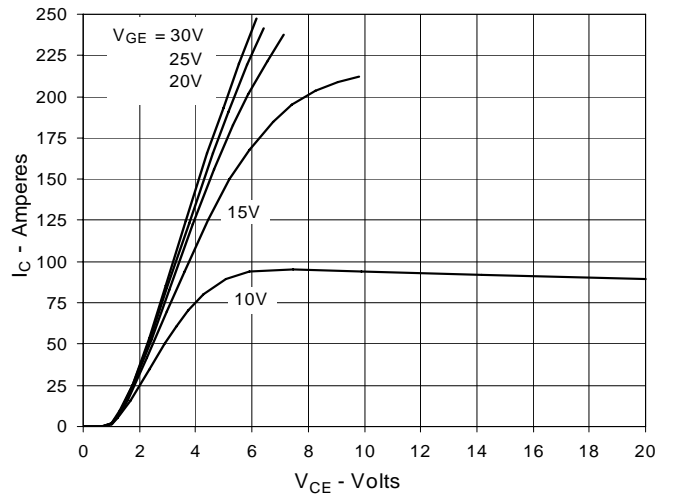

**Fig. 3. Output Characteristics  
@ 125°C**

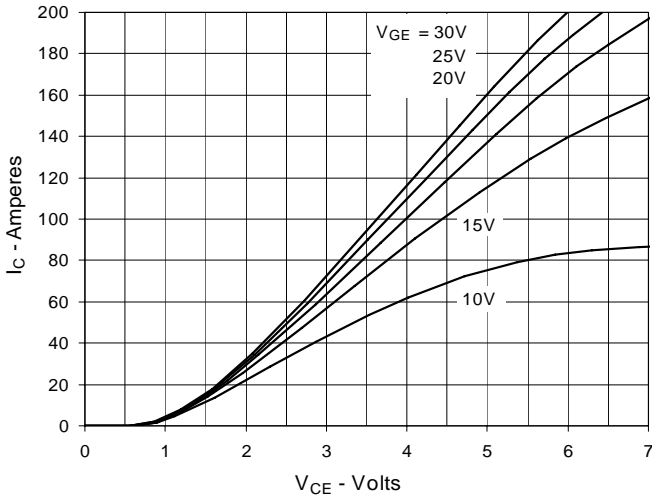

**Fig. 4. Dependence of VCE(sat) on  
Junction Temperature**

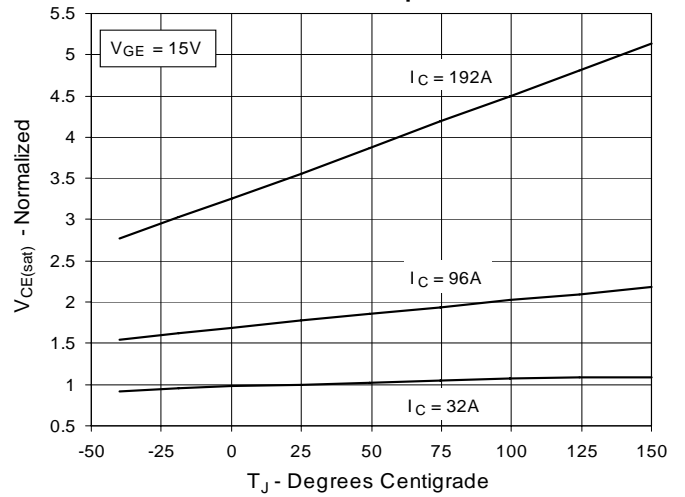

**Fig. 5. Collector-to-Emitter Voltage  
vs. Gate-to-Emitter Voltage**

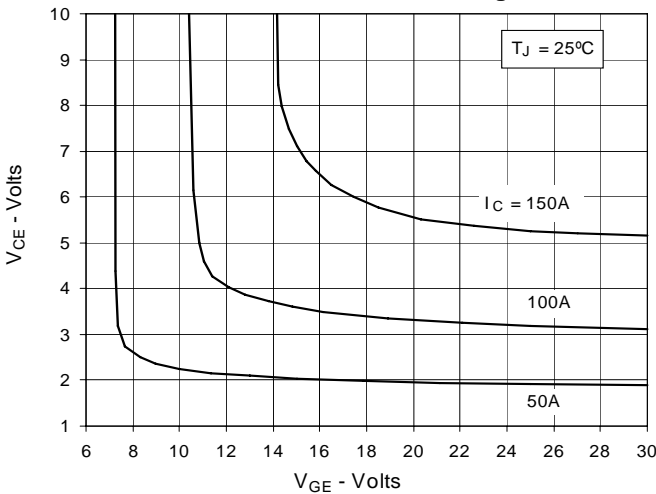

**Fig. 6. Input Admittance**

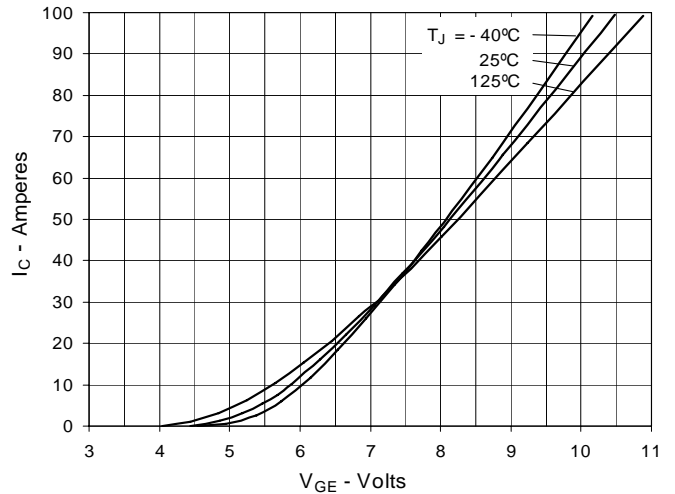

**Fig. 7. Transconductance**

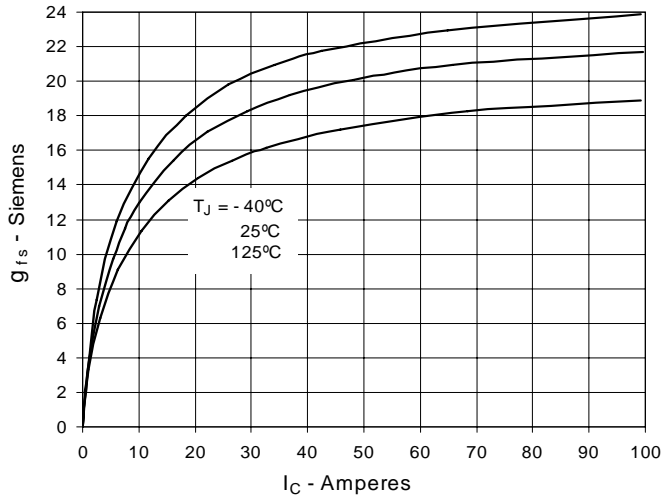

**Fig. 8. Dependence of  $BV_{CES}$  &  $V_{(th)GE}$  on Junction Temperature**

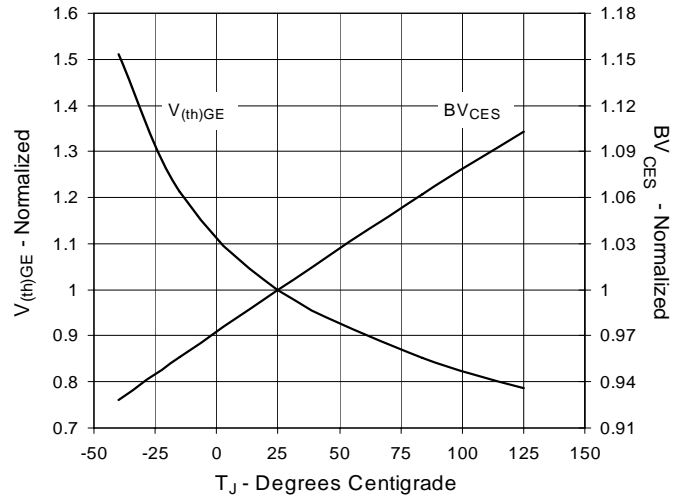

**Fig. 9. Single-Pulsed Avalanche Energy vs. Junction Temperature**

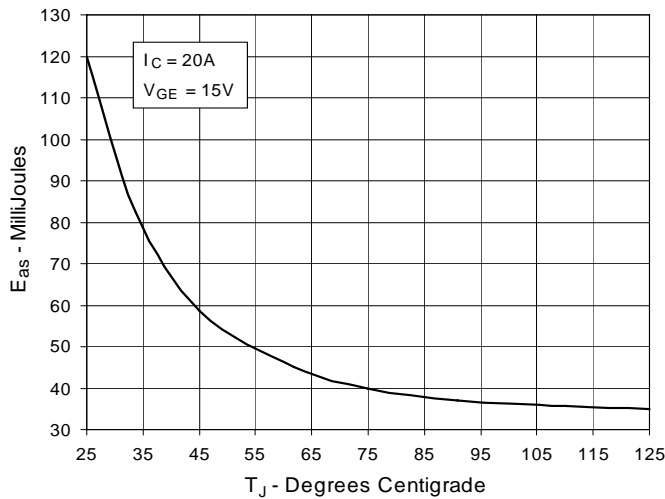

**Fig. 10. Resistive Turn-on Rise Time vs. Gate Voltage**

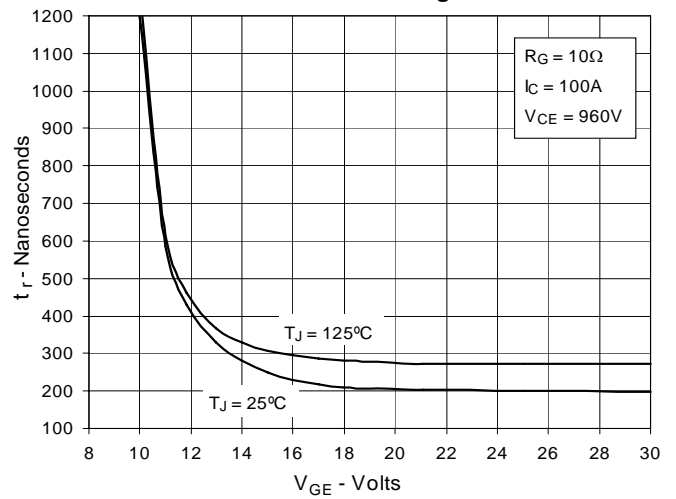

**Fig. 11. Resistive Turn-on Rise Time vs. Junction Temperature**

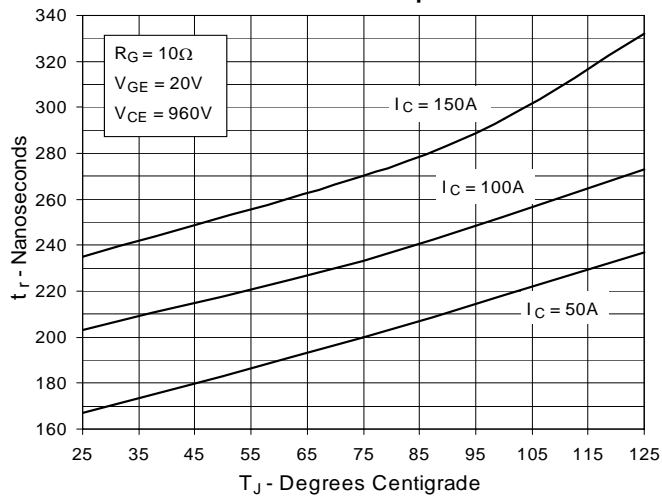

**Fig. 12. Resistive Turn-on Rise Time vs. Collector Current**

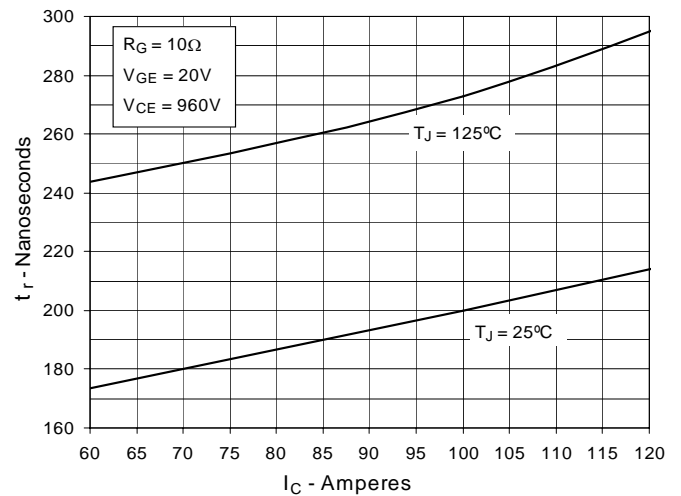

**Fig. 13. Resistive Turn-on Switching Times vs. Gate Resistance**

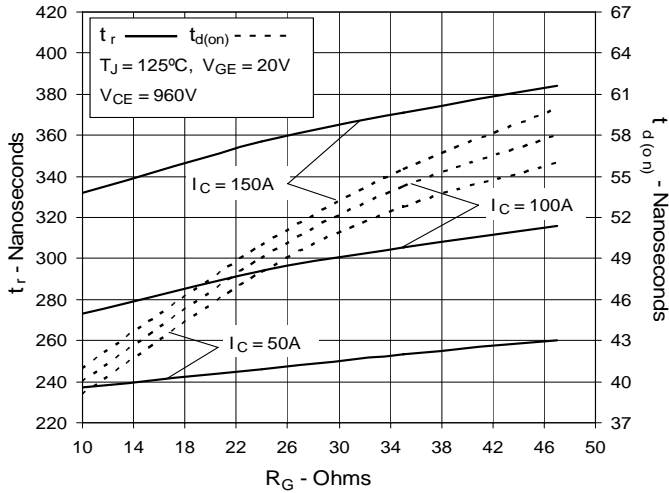

**Fig. 14. Resistive Turn-off Switching Times vs. Junction Temperature**

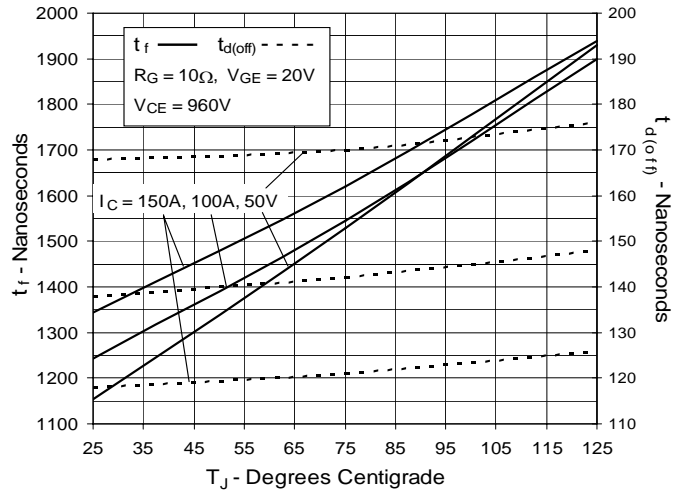

**Fig. 15. Resistive Turn-off Switching Times vs. Collector Current**

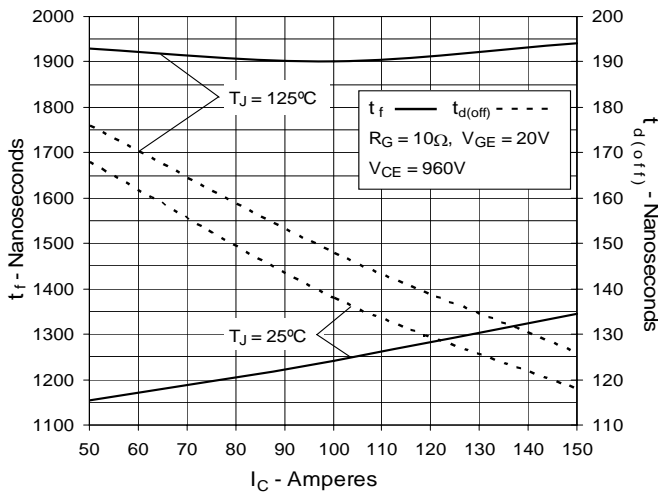

**Fig. 16. Resistive Turn-off Switching Times vs. Gate Resistance**

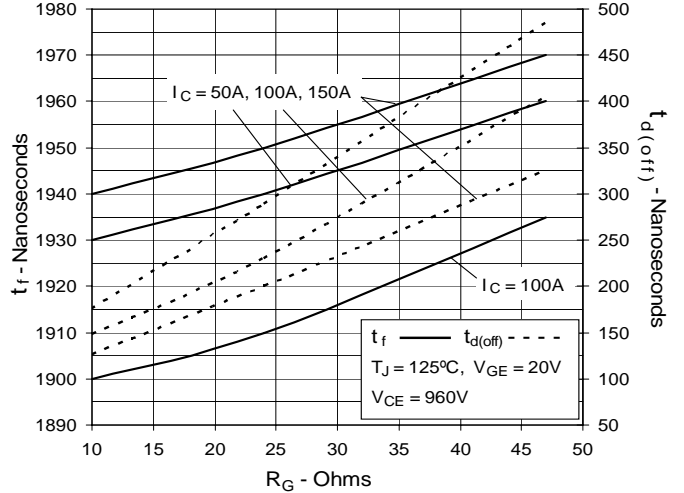

**Fig. 17. Gate Charge**

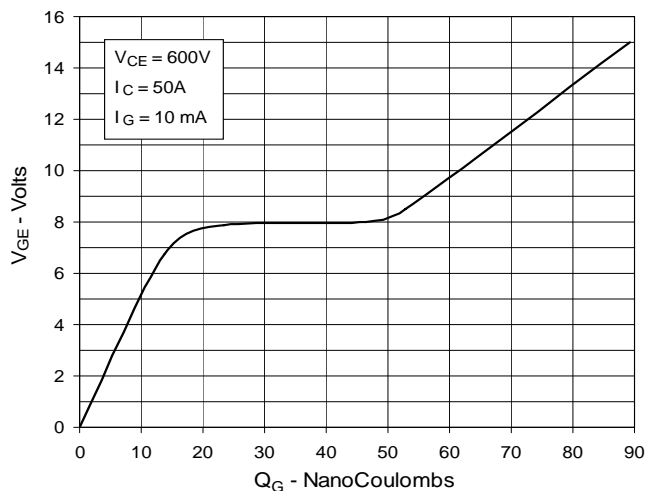

**Fig. 18. Reverse-Bias Safe Operating Area**

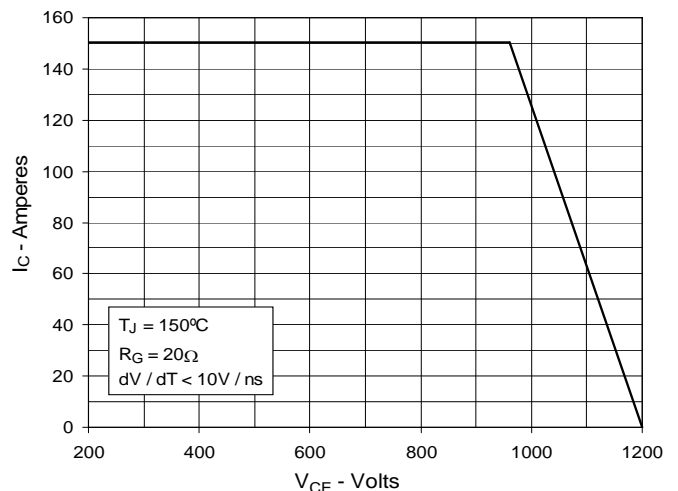

**Fig. 19. Capacitance**

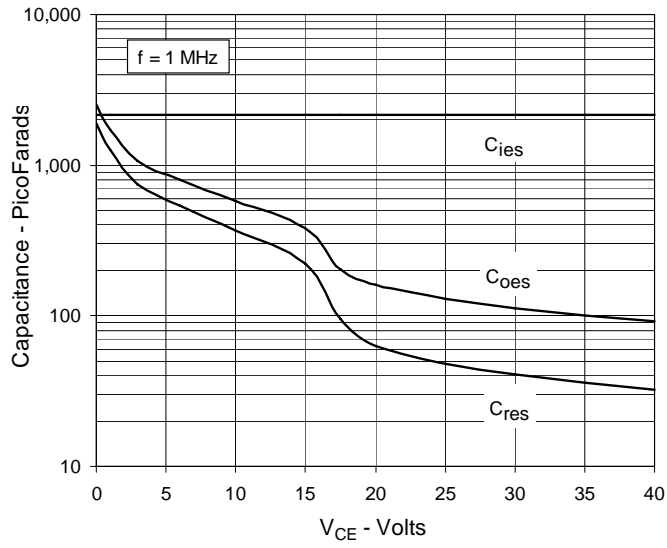

**Fig. 20. Maximum Transient Thermal Resistance**

